

---

# PBN-9007

## COM Express Mini Type 10 Carrier Board

### Quick Installation Guide

Version 1.2

Form Factor
<b>COM Express Carrier Board</b>

Video
<b>Single Channel LVDS, Display Port</b>

Audio
<b>ALC662 CODEC, Line-out, Mic-in,</b>

I/O
<b>SATA, USB, COM, SIM, Mini-card, CFast</b>

Ethernet
<b>RJ-45 LAN Connector</b>

### ◆ Technical Support

If you have any technical difficulties, please consult the user's manual first at:  
<http://www.arbor.com.tw>

Please do not hesitate to call or e-mail our customer service when you still can not find out the answer.

<http://www.arbor.com.tw>

E-mail: [info@arbor.com.tw](mailto:info@arbor.com.tw)

FCC Class A

This device complies with Part 15 of the FCC Rules. Operation is subject to the following two conditions : (1) this device may not cause harmful interference, and (2) this device must accept any interference received, including interference that may cause undesired operation.

Copyright® All Rights Reserved.

4040900700120P



## COM Express Module Type Summary Features

COM Express supports seven pin-out Type apply to Basic and Extended form factors:  
 Module Type 1 and 10 supports single connector with two rows of pins (220 pins)  
 Module Type 2, 3, 4, 5 and 6 support two connectors with four rows of pins (440 pins)  
 Connector placement and most mounting holes have transparency between Form Factors.

The differences amount the Module Types are summarized in table below:

Module Type	1	10	2	3	4	5	6
Connectors	1	1	2	2	2	2	2
Connector Rows	A, B	A, B	A, B, C, D	A, B, C, D	A, B, C, D	A, B, C, D	A, B, C, D
PCIe Lanes (max)	6	4	22	22	32	32	24
PCI Bus	No	No	Yes	Yes	No	No	No
PATA - IDE	No	No	Yes	No	Yes	No	No
LAN (Max)	1	1	1	3	1	3	1
Serial Ports	No	0 / 2	No	No	No	No	0 / 2
Muxed SDVO	No	No	0 / 2	0 / 2	0 / 2	0 / 2	No
Digital Display I/F	No	No	No	No	No	No	0 / 3
USB 3.0 Ports	No	No	No	No	No	No	0 / 4
DDIs	No	No	No	No	No	No	0 / 3
LVDS Channel A	0 / 1	0 / 1	0 / 1	0 / 1	0 / 1	0 / 1	0 / 1
LVDS Channel B	0 / 1	No	0 / 1	0 / 1	0 / 1	0 / 1	0 / 1

---

## Specifications

Form Factor	COM Express Mini Type 10 Carrier Board
I/O Chips	Fintek F71869
Audio	ALC662 CODEC, Line-out, Mic-in with Phone Jack
Storage	1 x Serial ATA connector, 1 x CFast socket
Serial Port	COM1: RS-232 COM2: RS-232/422/485 selectable TX/RX COM Port (depending on CPU Module)
USB 2.0	4 x USB 2.0 ports
USB 3.0	2 x USB 2.0/3.0 ports
LCD	Single Channel LVDS connector
Display Port	DisplayPort connector
DIO	8-bit Digital Input/Output
Expansion Interface	1 x Mini-card full size socket
Operation Temp.	-40°C~85°C (-40°F~185°F)
Power Connector	+12V DC main functioning, Power Jack
Dimension (L x W)	95 x 125 mm (3.7" x 4.9")

## Packing List

Before you begin installing your single board, please make sure that the following materials have been shipped:

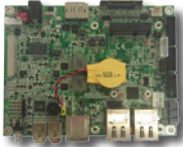

1 x PBN-9007 COM Express Mini Type 10 Carrier board



1 x Quick Installation Guide

## Ordering Information

PBN-9007	COM Express Mini Type 10 Carrier Board
Cable Kit	CBK-05-9007-00

# Board dimensions

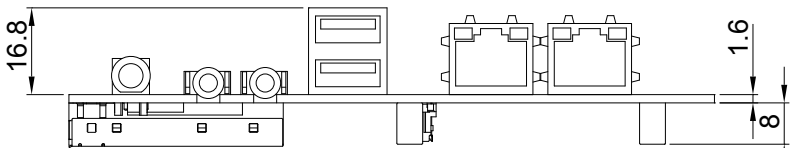
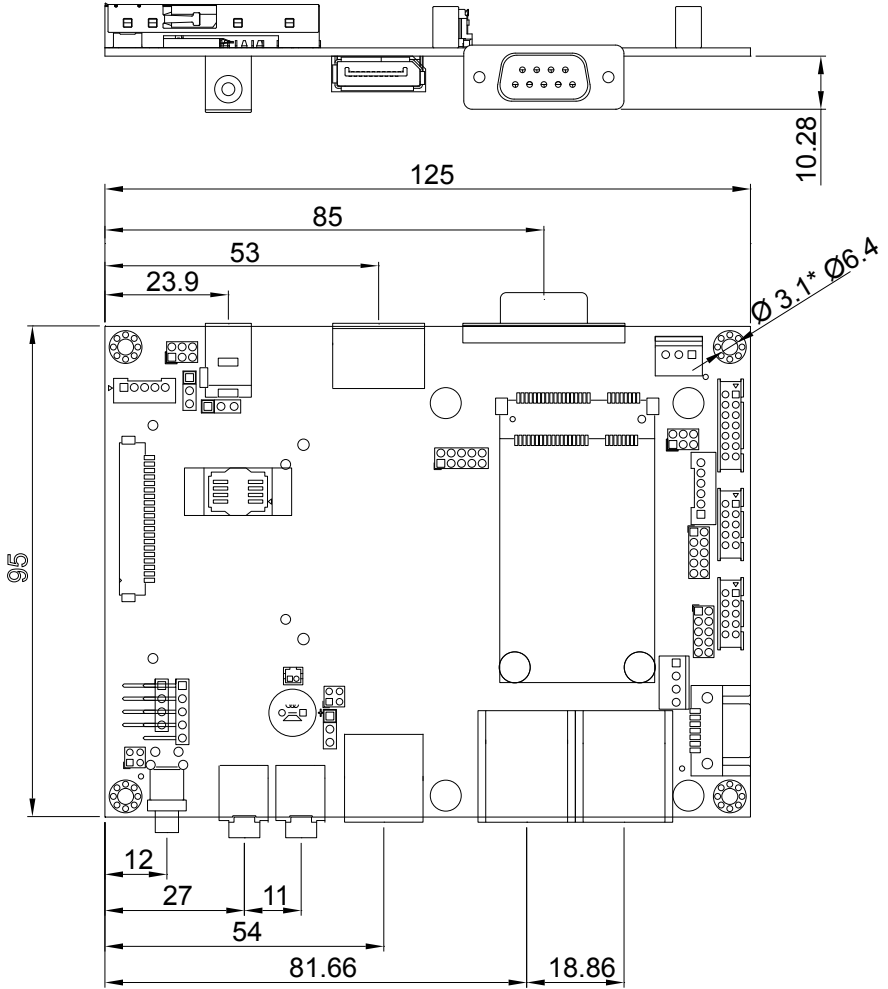

Unit:mm

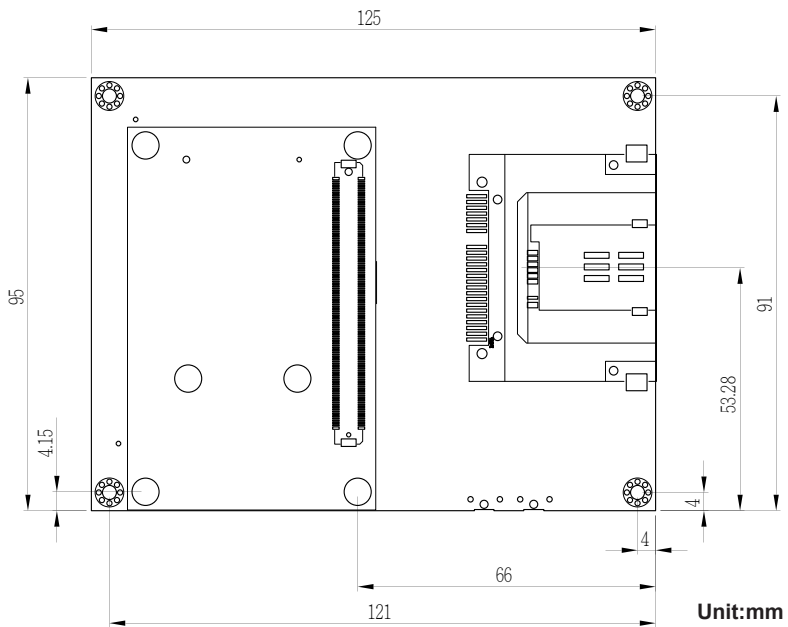

Unit:mm

---

## Jumpers/ Connectors Quick Reference

### Jumpers

<b>Label</b>	<b>Description</b>
JRS1	COM 2 RS-232/422/485 Serial Port Selection
JP1	AT / ATX, BIOS From CPU Module / Carrier Board Selection
JBAT1	Clear CMOS Setting
JLCD2	LCD Mode S election
JINV1	Inverter Voltage Setting
JBL1	LVDS Brightness Control Mode Selection
JLCD1	LCD Voltage Setting
JTOP1	CPU Board Power Source Selection

---

## Connectors

<b>Label</b>	<b>Function</b>
COM2	RS-232/422/485 Serial Port Connector
DIO1	Digital I/O Connector
JFRT1	Front-panel switches and LED Indicators Connector
USB2	USB Connector
USB3	USB Connector
SATA1	Serial ATA Connector
PWR1	SATA Power Connector
LAN1, LAN2	Ethernet Connectors
USB1	Double Stack USB 2.0/3.0 Connector
MIC1	Microphone
LINE_OUT1	Line-out
PW1	Power Button
5W_T1	Touch Screen Connector
LVDS1	LVDS Connector
INV1	LCD Inverter Connector
PADP1	DC Power Connector
CON1	CPU Board COM Port
DP1	DisplayPort Connector
COM1	RS-232 Serial Port
CPUF1	Fan Power Connector
KBMS1	KB/MS Connector
MC1	Mini-Card Socket
CF1	CFast Socket
SIM1	SIM Card Socket

# Jumpers

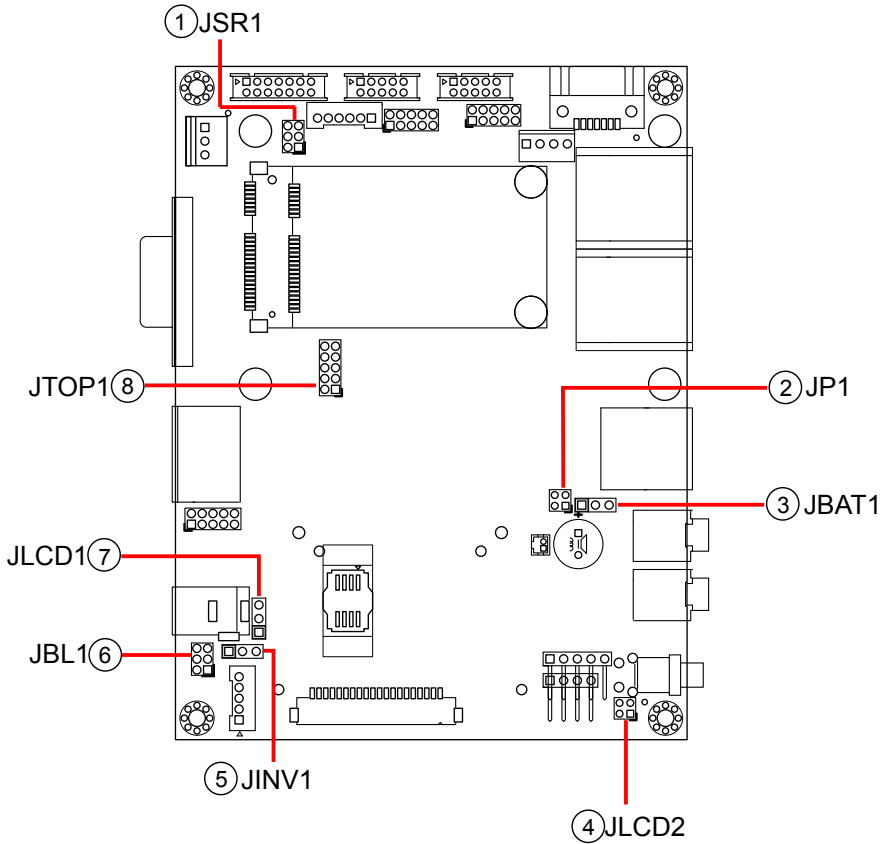



# Connectors

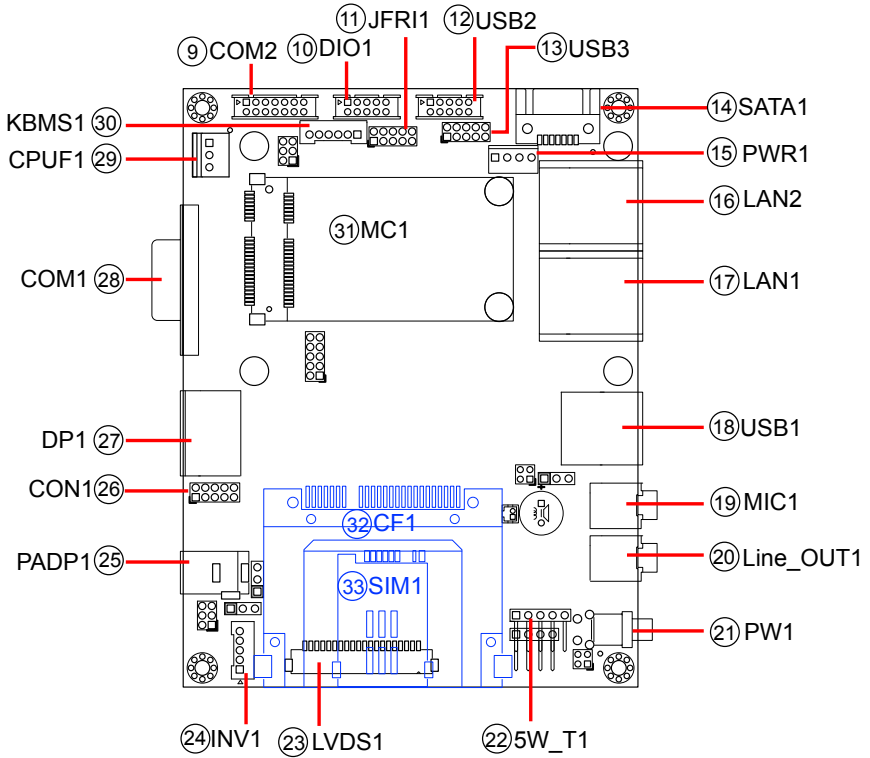



## Jumpers

### JRS1: COM2 RS-232/422/485

#### Serial Port Selection(1)



Connector type: 2.00mm pitch 2x3-pin headers.

Mode	RS-232 (Default)	RS-422	RS-485
1-2	Short	Open	Open
3-4	Open	Short	Open
5-6	Open	Open	Short



### JP1: AT/ATX Mode Selection (2)

Connector type: 2.00mm pitch 1x2-pin header.

Pin	Description	
1-2 ON	AT Mode	
1-2 OFF	ATX Mode	



### JP1: BIOS from CPU Board / Carrier Board Selection (2)

Connector type: 2.00mm pitch 1x2-pin header.

Pin	Description	
3-4 ON	CPU	
3-4 OFF	Carrier	



### JBAT1: Clear CMOS Setting (3)

Connector type: 2.00mm pitch 1x3-pin header.

Pin	Mode	
1-2	keep CMOS (default)	
2-3	clear CMOS	

### JLCD2: LVDS Panel Mode Selection (4)



Connector type: 2.00mm pitch 2x2-pin headers.

Pin	LCD	Mode	
1-3	Scan Direction	0V:ON, High:Off	
2-4	Frame Rate	0V:ON, High:Off	

### JINV1: LCD Inverter Voltage Selection (5)





The voltage of inverter could be selected by JINV1 in +5V or +12V.

Connector type: 2.00mm pitch 1x3-pin header.

Pin	Voltage	
1-2	+5V	
2-3	+12V (default)	

### JBL1: LVDS1 Brightness Control Level and Mode Selection (6)

Connector type: 2.00mm pitch 2x3-pin headers.



Pin	Brightness Control Source	
1-3	5V PWM mode control (default)	
3-5	3.3V PWM mode control	
2-4	5V DC level control	
4-6	0V DC level control	

## JLCD1: LVDS Panel Voltage

### Selection (7)

The voltage of LVDS panel could be selected by JVLCD1 in +5V or +3.3V.



Connector type: 2.00mm pitch 1×3-pin header.

Pin	Voltage	
1-2	+5V	
2-3	+3.3V (default)	

## JTOP1: CPU Board Power Source

### Selection (8)

Connector type: 2.00mm pitch 2×5-pin headers.

Pin	LCD	
1-2 3-4	12V (default)	
5-6 7-8 9-10	5V	

## Connectors

### COM2: RS-232/422/485

#### Serial Port (9)

Connector type: 2.00mm pitch 2×7-Pin lockable box headers.

Pin	Desc.	Pin	Desc.
2	DCD2	1	RXD2
4	TXD2	3	DTR2
6	GND	5	DSR2
8	RTS2	7	CTR2
10	RI2	9	NC
12	422TX+ /485+	11	422TX- /485-
14	422RX+	13	422RX-

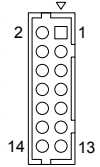

### DIO1: Digital I/O Connector (10)

DIO1 is a 8-bit GPIO connector.

Connector type: 2.00mm pitch 2×5-pin lockable box headers.

Pin	Desc.	Pin	Desc.
2	DIO0	1	DIO1
4	DIO2	3	DIO3
6	DIO4	5	DIO5
8	DIO6	7	DIO7
10	+5V	9	GND

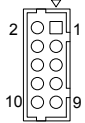

### JFRT1: Front-panel switches and

#### LED Indicators Connector (11)

Connector type: 2.00mm pitch 2×5-pin headers.

Pin	Desc.	Pin	Desc.
1	RESET+	2	RESET-
3	Power LED+	4	Power LED-
5	HD LED+	6	HD LED-
7	Speak+	8	Speak-
9	POSN+	10	POSN-

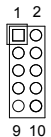

## USB2: USB Connector (12)

Connector type: 2.00mm pitch 2x5-pin lockable box headers.

Pin Desc.	Pin Desc.
2 +5V	1 +5V
4 USB-	3 USB-
6 USB+	5 USB+
8 GND	7 GND
10 GND	9 GND

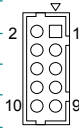

## USB3: USB Connector (13)

Connector type: 2.00mm pitch 2x5-pin headers.

Pin Desc.	Pin Desc.
1 +5V	2 +5V
3 USB-	4 USB-
5 USB+	6 USB+
7 GND	8 GND
9 GND	10 GND

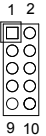

## SATA1: Serial ATA Connector (14)

Support high speed transfer rates and SATA RAID function.

Connector type: Standard 7-pin SATA connector.

Pin	Description
1	GND
2	TX+
3	TX-
4	GND
5	RX-
6	RX+
7	GND

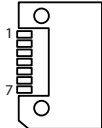

## PWR1: SATA Power Connector (15)

Connector type: 1x4-pin wafer connector

Pin Description
1 5V
2 GND
3 GND
4 12V

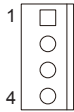

## LAN1, 2: Ethernet Connectors (16, 17)

Connector type: RJ-45 connectors

The pin assignments conform to the industry standard.



## USB1: Double Stack USB 2.0/3.0 Connector (18)

Connector type: double stack USB 2.0/3.0 type A connector.

The pin assignments conform to the industry standard.

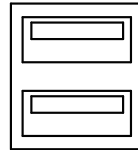

## MIC1: Microphone (19)

Connector type: Audio jack (Pink)



## LINE\_OUT1: Line-out (20)

Connector type: Phone jack (Green)



## PW1: Power Button (21)



## 5W\_T1: Touch Screen Connector (22)

Connector type: 2.54mm pitch, 1×5-pin wafer connector.

Pin	Description
1	UL
2	UR
3	PROBE
4	LR
5	LL

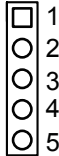

## CON1: CPU Board COM Port (26)

Connector type: 2.0mm pitch, 2x5-pin headers

Pin Desc.	Pin Desc.
1 3.3V	2 3.3V
3 NC	4 NC
5 RX0	6 RX1
7 GND	8 GND
9 TX0	10 TX1

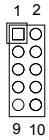

## LVDS1: LVDS Connector (23)

Connector type: 1.25mm FI-SE20P-HFE

Pin Desc.	Pin Desc.
1 TX3+	2 TX3-
3 SCAN DIRECTION	4 FRAME RATE
5 GND	6 CLK+
7 CLK-	8 GND
9 TX2+	10 TX2-
11 GND	12 TX1+
13 TX1	14 GND
15 TX0+	16 TX0-
17 GND	18 GND
19 VDD	20 VDD

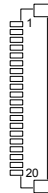

## DP1: DisplayPort Connector (27)

Connector type: DisplayPort digital video connector

The pin assignments conform to the industry standard.

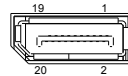

## COM1: RS-232 Serial Port (28)

Connector type: DB9 male connector

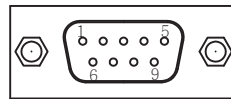

## INV1: LCD Inverter Connector (24)

Connector type: 2.0mm pitch, 1×5-pin wafer connector.

Pin	Description
1	+12V
2	GND
3	Backlight on/off
4	Brightness control
5	GND

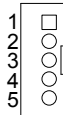

Pin	Desc.	Pin	Desc.
1	DCD1	2	RXD1
3	TXD1	4	DTR1
5	GND	6	DSR1
7	RTS1	8	CTS1
9	RI1	10	NC

## PADP1: DC Power Connectors (25)

Connector type: DC power jack connector.

Pin	Description
1	DC_IN
2	GND
3	GND

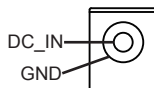

### CPUF1: Fan Power Connector (29)

Connector type: 12V 2.54mm 1x3-pin wafer connector.

Pin	Description
1	GND
2	+12V
3	Fan_Detect



### KBMS1: KB/MS Connector(30)

Connector type: 2.00mm pitch 1x6-pin wafer connector.

Pin	Description
1	KB_DAT
2	GND
3	MS_DAT
4	KB_CLK
5	PS2_VCC
6	MS_CLK

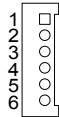

### MC1: Mini-card Socket (31)

Connector type: Onboard 0.8mm-pitch 52-pin edge card connector

The pin assignments conform to the industry standard.

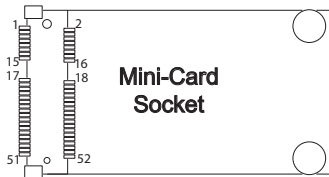

### CF1: CFast Socket (32) (On Bottom Side)

Connector type: CFast connector

The pin assignments conform to the industry standard.

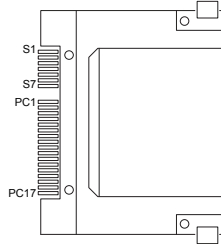

### SIM1: SIM Card Socket (33) (On Bottom Side)

Connector type: Foxconn WL618E2-U05-7F CX1 socket

Pin	Description
C1	VCC
C2	RST
C3	CLK
C5	GND
C6	VPP
C7	IO

