EmETXe-i89M3

**COM Express® Basic
Type 6 CPU Module**

User's Manual Version 1.3

Revision History

Version	Date	Description
1.0	Mar, 2017	Initial release
1.1	Jun, 2017	Add HS: HS-89M0-F1
1.2	Mar, 2019	1.Remove driver CD from the package contents and revise driver installation instructions. 2.Add SKU:Xeon E3-1505L 3. Update BIOS section to version 1.03
1.3	May, 2019	Add SKU "EmETXe-i89M3-WT-1505M". Revised sections include: - 1.1 Product features - 1.3 Specification - 1.5 Ordering information - 2.3 Block diagram

Preface	iii
Copyright Notice.....	iii
Declaration of Conformity	iii
CE.....	iii
FCC Class B	iii
RoHS.....	iv
SVHC / REACH.....	iv
Warning	v
Replacing the Lithium Battery.....	v
Technical Support	v
Warranty	vi
Chapter 1 - Introduction	1
1.1 The Product.....	2
1.2 About This Manual.....	2
1.3 Specifications	3
1.4 Inside the Package	4
1.5 Ordering Information.....	4
1.5.1 Optional Accessories.....	4
1.6 Driver Installation	5
Chapter 2 - Board Overview	7
2.1 What Is “COM Express®”?	8
2.2 Board Dimensions.....	9
2.3 Block Diagram	10
2.4 Connector Pin Definition	11
Chapter 3 - Installation & Maintenance	15
3.1 Installing the CPU Module on Carrier Board.....	16
3.2 Installing the Heatsink	17

Chapter 4 - BIOS	19
4.1 Main	20
4.2 Advanced.....	22
4.2.1 CPU Configuration	23
4.2.2 PCI Subsystem Settings	25
4.2.3 ACPI Settings	26
4.2.4 SATA Configuration.....	27
4.2.5 USB Configuration	28
4.2.6 AMT Configuration	30
4.2.7 Hardware Monitor	31
4.2.8 Super IO Configuration	32
4.2.9 S5 RTC Wake Settings	34
4.2.10 CSM Configuration	35
4.3 Chipset	36
4.3.1 Graphics Configuration	38
4.3.2 PEG Port Configuration	40
4.3.3 Memory Configuration	41
4.3.4 LCD Control	42
4.3.5 PCI Express Configuration	43
4.3.6 USB Configuration	44
4.4 Security	45
4.5 Boot	46
4.6 Save & Exit.....	47
Appendix	48
Appendix A: I/O Port Address Map	49
Appendix B: BIOS Memory Mapping	50
Appendix C: Interrupt Request Lines (IRQ)	52
Appendix D: Watchdog Timer (WDT) Setting.....	53
Appendix E: DIO Sample Code	55

Copyright Notice

All Rights Reserved.

The information in this document is subject to change without prior notice in order to improve the reliability, design and function. It does not represent a commitment on the part of the manufacturer.

Under no circumstances will the manufacturer be liable for any direct, indirect, special, incidental, or consequential damages arising from the use or inability to use the product or documentation, even if advised of the possibility of such damages.

This document contains proprietary information protected by copyright. All rights are reserved. No part of this manual may be reproduced by any mechanical, electronic, or other means in any form without prior written permission of the manufacturer.

Declaration of Conformity

CE

The CE symbol on your product indicates that it is in compliance with the directives of the Union European (EU). A Certificate of Compliance is available by contacting Technical Support.

This product has passed the CE test for environmental specifications when shielded cables are used for external wiring. We recommend the use of shielded cables. This kind of cable is available from ARBOR. Please contact your local supplier for ordering information.

This product has passed the CE test for environmental specifications. Test conditions for passing included the equipment being operated within an industrial enclosure. In order to protect the product from being damaged by ESD (Electrostatic Discharge) and EMI leakage, we strongly recommend the use of CE-compliant industrial enclosure products.

Warning

This is a class A product. In a domestic environment this product may cause radio interference in which case the user may be required to take adequate measures.

FCC Class B

This device complies with Part 15 of the FCC Rules. Operation is subject to the following two conditions:

- (1) This device may not cause harmful interference, and
- (2) This device must accept any interference received, including interference that may cause undesired operation.

NOTE:

This equipment has been tested and found to comply with the limits for a Class A digital device, pursuant to Part 15 of the FCC Rules. These limits are designed to provide reasonable protection against harmful interference when the equipment is operated in a commercial environment. This equipment generates, uses, and can radiate radio frequency energy and, if not installed and used in accordance with the instruction manual, may cause harmful interference to radio communications. Operation of this equipment in a residential area is likely to cause harmful interference in which case the user will be required to correct the interference at his own expense.

RoHS

ARBOR Technology Corp. certifies that all components in its products are in compliance and conform to the European Union's Restriction of Use of Hazardous Substances in Electrical and Electronic Equipment (RoHS) Directive 2002/95/EC.

The above mentioned directive was published on 2/13/2003. The main purpose of the directive is to prohibit the use of lead, mercury, cadmium, hexavalent chromium, polybrominated biphenyls (PBB), and polybrominated diphenyl ethers (PBDE) in electrical and electronic products. Member states of the EU are to enforce by 7/1/2006.

ARBOR Technology Corp. hereby states that the listed products do not contain unintentional additions of lead, mercury, hex chrome, PBB or PBDB that exceed a maximum concentration value of 0.1% by weight or for cadmium exceed 0.01% by weight, per homogenous material. Homogenous material is defined as a substance or mixture of substances with uniform composition (such as solders, resins, plating, etc.). Lead-free solder is used for all terminations (Sn(96-96.5%), Ag(3.0-3.5%) and Cu(0.5%)).

SVHC / REACH

To minimize the environmental impact and take more responsibility to the earth we live, Arbor hereby confirms all products comply with the restriction of SVHC (Substances of Very High Concern) in (EC) 1907/2006 (REACH --Registration, Evaluation, Authorization, and Restriction of Chemicals) regulated by the European Union.

All substances listed in SVHC < 0.1 % by weight (1000 ppm)

Warning

Single Board Computers and their components contain very delicate Integrated Circuits (IC). To protect the Single Board Computer and its components against damage from static electricity, you should always follow the following precautions when handling it :

1. Disconnect your Single Board Computer from the power source when you want to work on the inside.
2. Hold the board by the edges and try not to touch the IC chips, leads or circuitry.
3. Use a grounded wrist strap when handling computer components.
4. Place components on a grounded antistatic pad or on the bag that comes with the Single Board Computer, whenever components are separated from the system.

Replacing the Lithium Battery

Incorrect replacement of the lithium battery may lead to a risk of explosion.

The lithium battery must be replaced with an identical battery or a battery type recommended by the manufacturer.

Do not throw lithium batteries into the trash-can. It must be disposed of in accordance with local regulations concerning special waste.

Technical Support

If you need technical support with the product, please contact us via our website or email:

<https://www.arbor-technology.com>

E-mail: info@arbor.com.tw

Warranty

This product is warranted to be in good working order for a period of two years from the date of purchase. Should this product fail to be in good working order at any time during this period, we will, at our option, replace or repair it at no additional charge except as set forth in the following terms. This warranty does not apply to products damaged by misuse, modifications, accident or disaster.

Vendor assumes no liability for any damages, lost profits, lost savings or any other incidental or consequential damage resulting from the use, misuse of, or inability to use this product. Vendor will not be liable for any claim made by any other related party.

Vendors disclaim all other warranties, either expressed or implied, including but not limited to implied warranties of merchantability and fitness for a particular purpose, with respect to the hardware, the accompanying product's manual(s) and written materials, and any accompanying hardware. This limited warranty gives you specific legal rights.

Return authorization must be obtained from the vendor before returned merchandise will be accepted. Authorization can be obtained by calling or faxing the vendor and requesting a Return Merchandise Authorization (RMA) number. Returned goods should always be accompanied by a clear problem description.



Chapter 1

Introduction

1.1 The Product

The EmETXe-i89M3 is a space-conscious CPU board of 125 mm x 95 mm to take up only small footprint in your system. By the architecture of Type 6, the board has two high-performance connectors to promise stable data passing rate. The soldered onboard 6th Generation Intel® Core™ processor, along with integrated Intel® Graphics chipset, bring LVDS, analog RGB, and DDI solution for most monitors or LCD video panels.

For system configuration, the board is supported by AMI UEFI BIOS. EmETXe-i89M3 is an ideal choice for some demanding industrial control and data communications by its significant processing performance, low power consumption and these features:

- Soldered onboard 6th Generation Intel® Core™ i7-6822EQ / i5-6442EQ / Xeon E3-1505L v5 / E3-1505M v5
- Intel I219LM PCIe GbE PHY w/ iAMT
- Dual Channels 24-bit LVDS and 2 x DDI ports, analog RGB
- Support 2 independent displays
- 5V~20V Wide Range Voltage Input
- Wide Range Operating Temp.: -40 ~ 85°C

1.2 About This Manual

This user's manual provides general information and installation instructions about the product. This user's manual is intended for experienced users and integrators with hardware knowledge of personal computers. If you are not sure about any description in this booklet. Please consult your vendor before further handling.

1.3 Specifications

Specifications

System	
CPU	Soldered onboard 6 th Generation Intel® Core™ i7-6822EQ 2.8GHz / i5-6442EQ 2.7GHz / Xeon E3-1505L v5 / E3-1505M v5 2.8GHz
Chipset	Intel® PCH QM170 for i7-6822EQ / i5-6442EQ CM236 for Xeon E3-1505L v5 / E3-1505M v5
Memory	2 x DDR4 SO-DIMM sockets
BIOS	AMI UEFI BIOS
Watchdog Timer	1~255 levels reset
I/O	
USB 2.0	8 x USB 2.0 ports
USB 3.0	4 x USB 3.0 ports
Serial Port	2 x UART ports (RX/TX only)
Storage	4 x Serial ATA ports with 600MB/s HDD transfer rate
Expansion Bus	8 x PCIe lanes, I2C Interface, GPIO
Ethernet Chipset	1 x Intel® i219LM PCIe GbE PHY with iAMT
Audio	HD audio link
TPM Function	TPM supported (OEM request)
Display	
Graphics Chipset	Integrated Intel® HD Graphics 530
Graphics Interface	LCD: Dual Channels 24-bit LVDS
	Analog RGB
	2 x DDI ports
Mechanical & Environmental	
Power Requirement	5V~20V +/- 5% wide range voltage input, +5VSB
Power Consumption	2.07A@12V (i7-6822EQ typical)
Operating Temp.	-40 ~ 85°C (-40 ~ 185°F)
Operating Humidity	10 ~ 95% @ 85°C (non-condensing)
Dimension (L x W)	125 x 95 mm (4.9" x 3.7")

1.4 Inside the Package

Before you begin installing your single board, please make sure that the following materials have been shipped:



1 x EmETXe-i89M3 COM Express CPU Module



1 x Quick Installation Guide

If any of the above items is damaged or missing, contact your vendor immediately.

1.5 Ordering Information

EmETXe-i89M3-WT-6822EQ	WT COME Type 6 Basic CPU Module, i7-6822EQ, w/ VGA, -40 ~ 85°C
EmETXe-i89M3-WT-6442EQ	WT COME Type 6 Basic CPU Module, i5-6442EQ, w/ VGA, -40 ~ 85°C
EmETXe-i89M3-WT-1505L	WT COME Type 6 Basic CPU Module, E3-1505L v5, w/ VGA, -40 ~ 85°C
EmETXe-i89M3-WT-1505M	WT COME Type 6 Basic CPU module, E3-1505M v5, w/ VGA, -40 ~ 85°C

1.5.1 Optional Accessories

HS-89M0-C1	Heat sink with FAN (125x95x35mm)
HS-89M0-F1	Heat spreader with PAD (125x95x18mm)
PBE-1705-F1	COM Express® Type 6 evaluation carrier board with SIO F71869ED module in ATX form factor
CBK-03-1705-00	Cable kit <ul style="list-style-type: none">• 1 x SATA cable• 2 x COM Flat cables

1.6 Driver(6.6A) Installation

To install the drivers, please visit our website at www.arbor-technology.com and download the driver pack from the product page.

Driver	Path
Chipset	\\i89X\Chipset\Chipset_10.1.1.13_Public
Graphic	\\i89X\Graphic\IntelR Graphics Driver Production Version 15.40.16.64.4364
Audio	\\i89X\Audio\7687_PG436_Win10_Win8.1_Win8_Win7_WHQLx64
Ethernet	\\i89X\Ethernet
USB3.0	\\i89X\USB3.0\win8.1 64bit\Intel_USB_3.0_xHC_Adaptation_Driver_MR1_Release_1.0.1.45_PV (For Win 8.1 only)
ME	\\i89X\ME\Intel(R)_ME_11.0_Corporate_11.0.0.1202
RAID	\\i89X\RAID\Intel Rapid Storage Technology Driver 14.8.0.1042

This page is intentionally left blank.



Chapter 2

Board Overview

2.1 What Is “COM Express®”?

With more and more demands on small and embedded industrial boards, a multi-functional COM (Computer-on-Module) surfaces as a great solution.

COM Express® supports seven pin-out types applying to Basic and Extended form factors:

Module Type 1 and 10 support single connector with two rows (220 pins).

Module Type 2, 3, 4, 5 and 6 support two connectors with four rows (440 pins).

EmETXe-i89M3 is a Type-6 module.

Difference between Standard Type 6 and EmETXe-i89M3 is listed as below:

Module Type	Standard Type 6	EmETXe-i89M3
Connectors	2	2
Connector Rows	A, B, C, D	A, B, C, D
PCIe Lanes (Max)	24	24
LAN (Max)	1	1
Serial Ports (Max)	2	2
Digital Display I/F (Max)	3	2
USB 3.0 Ports (Max)	4	4

Row AB provides pins for PCI Express, SATA, LVDS, LCD channel, LPC bus, system and power management, VGA, LAN, and power and ground interfaces.

Row CD provides SDVO and legacy PCI signals next to additional PCI Express, LAN and power and ground signals. The COM are targeted at following applications:

- Retail & Advertising
- Medical
- Test & Measurement
- Gaming & Entertainment
- Industrial & Automation
- Military & Government
- Security

2.2 Board Dimensions

The following illustration shows the dimension of EmETXe-i89M3, with the measurements in width, depth, and height called out.

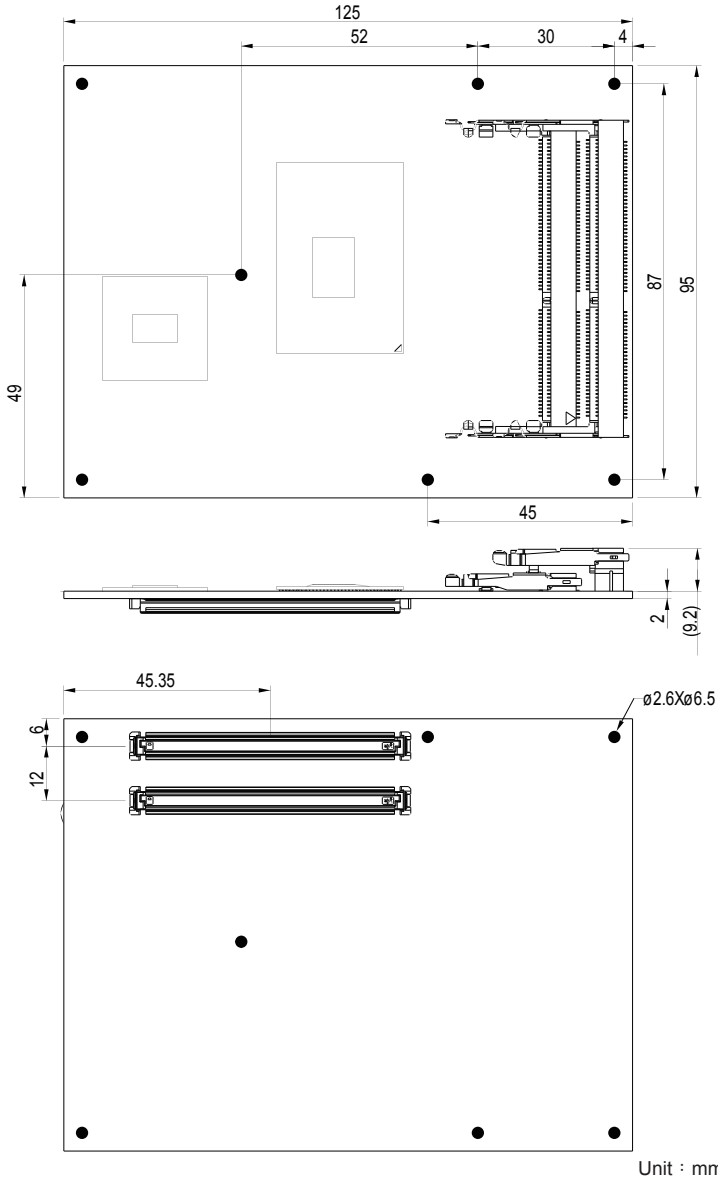

2.3 Block Diagram

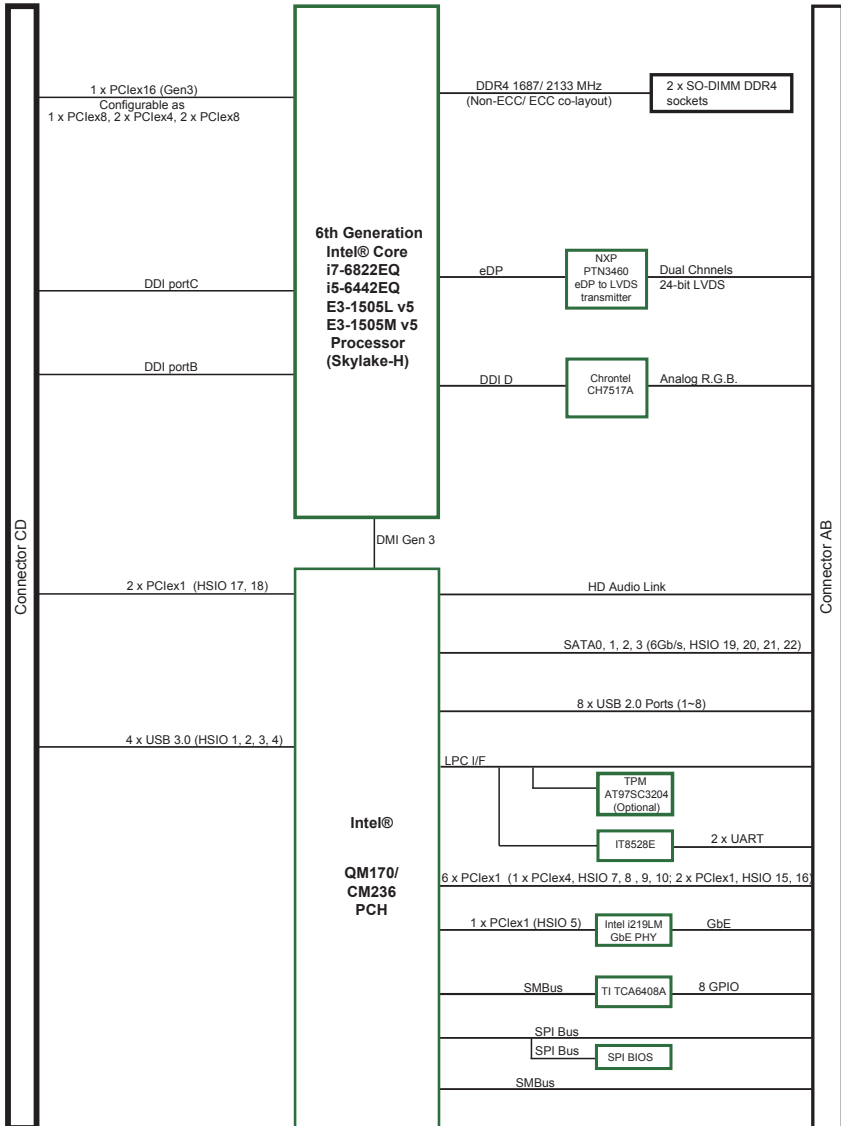

2.4 Connector Pin Definition

Being a most commonly-used Type 6, the EmETXe-i89M3 features two board-to-board connectors on bottom side.

Top Side

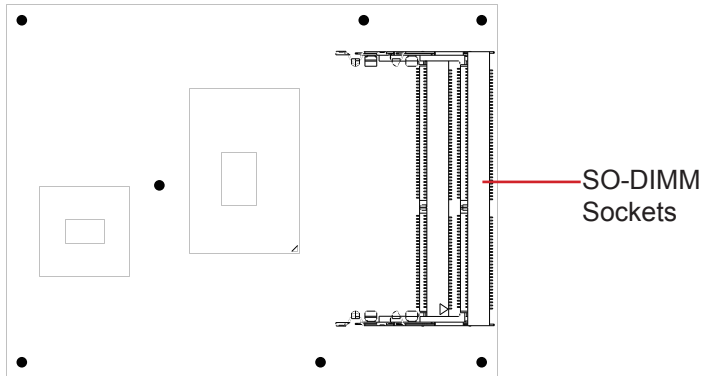

Bottom Side

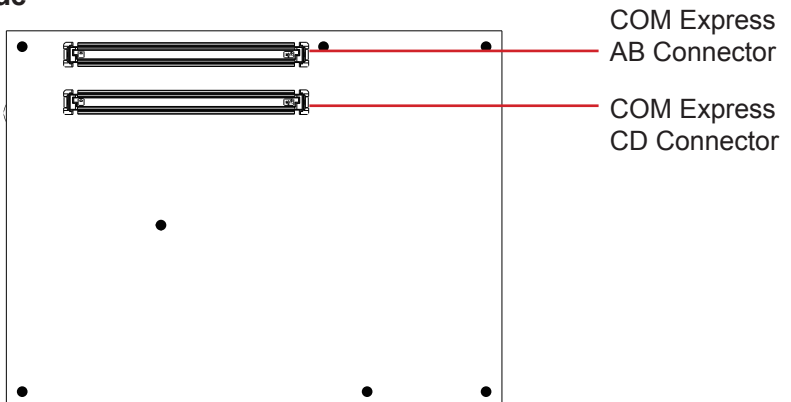

COM Express AB Connector (bottom side)

B1	GND (FIXED)	GND (FIXED)	A1	B56	PCIE_RXN9	PCIE_TXN9	A56
B2	LAN_LED_LNK#	LAN1_MDI3N	A2	B57	DIO_6	GND	A57
B3	LPC_FRAME#	LAN1_MDI3P	A3	B58	PCIE_RXP4	PCIE_TXP4	A58
B4	LPC_AD0	LAN_LED_100#	A4	B59	PCIE_RXN4	PCIE_TXN4	A59
B5	LPC_AD1	LAN_LED_1000#	A5	B60	GND	GND	A60
B6	LPC_AD2	LAN1_MDI2N	A6	B61	PCIE_RXP3	PCIE_TXP3	A61
B7	LPC_AD3	LAN1_MDI2P	A7	B62	PCIE_RXN3	PCIE_TXN3	A62
B8	LPC_DRQ0-	LAN_LED_LNK#	A8	B63	DIO_7	DIO_1	A63
B9	LPC_DRQ1-	LAN1_MDI1N	A9	B64	PCIE_RXP2	PCIE_TXP2	A64
B10	LPC_CLK	LAN1_MDI1P	A10	B65	PCIE_RXN2	PCIE_TXN2	A65
B11	GND (FIXED)	GND (FIXED)	A11	B66	PCH_WAKE#	GND	A66
B12	PWRBTN#	LAN1_MDI0N	A12	B67	EC_WAKE_IN#	DIO_2	A67
B13	CB_SMB_CLK	LAN1_MDI0P	A13	B68	PCIE_RXP1	PCIE_TXP1	A68
B14	CB_SMB_DATA	N/C	A14	B69	PCIE_RXN1	PCIE_TXN1	A69
B15	CB_SMB_ALERT#	SLP_S3#	A15	B70	GND	GND	A70
B16	SATA_TXP1_C	SATA_TXP0_C	A16	B71	LVDSB_DATA0	LVDSA_DATA0	A71
B17	SATA_TXN1_C	SATA_TXN0_C	A17	B72	LVDSB_DATA0-	LVDSA_DATA0-	A72
B18	SUS_STAT#	SLP_S4#	A18	B73	LVDSB_DATA1	LVDSA_DATA1	A73
B19	SATA_RXP1_N	SATA_RXP0_C	A19	B74	LVDSB_DATA1-	LVDSA_DATA1-	A74
B20	SATA_RXN1_C	SATA_RXN0_C	A20	B75	LVDSB_DATA2	LVDSA_DATA2	A75
B21	GND (FIXED)	GND (FIXED)	A21	B76	LVDSB_DATA2-	LVDSA_DATA2-	A76
B22	SATA_TXP3_C	SATA_TXP2_C	A22	B77	LVDSB_DATA3	LVDS_VDD_EN	A77
B23	SATA_TXN3_C	SATA_TXN2_C	A23	B78	LVDSB_DATA3-	LVDSA_DATA3	A78
B24	CB_PWROK	SLP_S5#	A24	B79	LVDS_BKLTEN	LVDSA_DATA3-	A79
B25	SATA_RXP3_C	SATA_RXP2_C	A25	B80	GND	GND	A80
B26	SATA_RXN3_C	SATA_RXN2_C	A26	B81	LVDSB_CLK	LVDSA_CLKP	A81
B27	WDT	PM_BATLOW#	A27	B82	LVDSB_CLK-	LVDSA_CLKN	A82
B28	N/C	SATALED-	A28	B83	LVDS_BKLT_CTRL	LVDS_DDC_CK	A83
B29	HDA_SDIN1	HDA_SYNC	A29	B84	VCC_5V_SBY	LVDS_DDC_DAT	A84
B30	HDA_SDIN0	HDA_RST-	A30	B85	VCC_5V_SBY	DIO_3	A85
B31	GND	GND	A31	B86	VCC_5V_SBY	H_RCIN#	A86
B32	SPKR	HDA_BIT_CLK	A32	B87	VCC_5V_SBY	EDP_HPD (Optional)	A87
B33	I2C_CLK	HDA_SDOUT	A33	B88	BIOS_DISABLE1#	COM_EXP_CLK_P	A88
B34	I2C_DAT	BIOS_DISABLE0#	A34	B89	CRT_RED	COM_EXP_CLK_N	A89
B35	THRM#	CB_TRIP#	A35	B90	GND	GND	A90
B36	USBP_7N	USBN_6N	A36	B91	CRT_GREEN	SPI_POWER	A91
B37	USBP_7P	USBN_6P	A37	B92	CRT_BLUE	SPI_MISO	A92
B38	USBOC_45-	USBOC_67-	A38	B93	CRT_HSYNC	DIO_4	A93
B39	USBP_5N	USBN_4N	A39	B94	CRT_VSYNC	SPI_CK	A94
B40	USBP_5P	USBN_4P	A40	B95	CRT_DDC_CLK	SPI_MOSI	A95
B41	GND	GND	A41	B96	CRT_DDC_DATA	TPM_PP	A96
B42	USBP_3N	USBN_2N	A42	B97	SPI_CS1#	N/C	A97
B43	USBP_3P	USBN_2P	A43	B98	N/C	UART_TX0	A98
B44	USBOC_01-	USBOC_23-	A44	B99	N/C	UART_RX0	A99
B45	USBP_1N	USBN_0N	A45	B100	GND	GND	A100
B46	USBP_1P	USBN_0P	A46	B101	FAN_PWMOUT	UART_TX1	A101
B47	PLTRST#_BUFF	VRTC_BTБ	A47	B102	FAN_TACHIN	UART_RX1	A102
B48	EXCD1_CPPE#	PLTRST#_BUFF	A48	B103	SLEEP#	LID#	A103
B49	CB_SYSRST#	EXCD0_CPPE#	A49	B104	VCC_12V	VCC_12V	A104
B50	CB_RESET#	LPC_SERIRQ	A50	B105	VCC_12V	VCC_12V	A105
B51	GND	GND	A51	B106	VCC_12V	VCC_12V	A106
B52	PCIE_RXP10	PCIE_TXP10	A52	B107	VCC_12V	VCC_12V	A107
B53	PCIE_RXN10	PCIE_TXN10	A53	B108	VCC_12V	VCC_12V	A108
B54	DIO_5	DIO_0	A54	B109	VCC_12V	VCC_12V	A109
B55	PCIE_RXP9	PCIE_TXP9	A55	B110	GND	GND	A110

COM Express CD Connector (bottom side)

D1	GND (FIXED)	GND (FIXED)	C1	D56	PEG_TXN1	PEG_RXN1	C56
D2	GND	GND	C2	D57	TYPE2#	N/C	C57
D3	USB3_TXN1	USB3_RXN1	C3	D58	PEG_TXP2	PEG_RXP2	C58
D4	USB3_TXP1	USB3_RXP1	C4	D59	PEG_TXN2	PEG_RXN2	C59
D5	GND	GND	C5	D60	GND (FIXED)	GND (FIXED)	C60
D6	USB3_TXN2	USB3_RXN2	C6	D61	PEG_TXP3	PEG_RXP3	C61
D7	USB3_TXP2	USB3_RXP2	C7	D62	PEG_TXN3	PEG_RXN3	C62
D8	GND	GND	C8	D63	RSVD	RSVD	C63
D9	USB3_TXN3	USB3_RXN3	C9	D64	RSVD	RSVD	C64
D10	USB3_TXP3	USB3_RXP3	C10	D65	PEG_TXP4	PEG_RXP4	C65
D11	GND (FIXED)	GND (FIXED)	C11	D66	PEG_TXN4	PEG_RXN4	C66
D12	USB3_TXN4	USB3_RXN4	C12	D67	GND	RSVD	C67
D13	USB3_TXP4	USB3_RXP4	C13	D68	PEG_TXP5	PEG_RXP5	C68
D14	GND	GND	C14	D69	PEG_TXN5	PEG_RXN5	C69
D15	DDI2_CLK_AUX	N/C	C15	D70	GND (FIXED)	GND (FIXED)	C70
D16	DDI2_CLK_AUX#	N/C	C16	D71	PEG_TXP6	PEG_RXP6	C71
D17	RSVD	RSVD	C17	D72	PEG_TXN6	PEG_RXN6	C72
D18	RSVD	RSVD	C18	D73	GND	GND	C73
D19	PCIE_TXP11	PCIE_RXP11	C19	D74	PEG_TXP7	PEG_RXP7	C74
D20	PCIE_TXN11	PCIE_RXN11	C20	D75	PEG_TXN7	PEG_RXN7	C75
D21	GND(FIXED)	GND(FIXED)	C21	D76	GND	GND	C76
D22	PCIE_TXP12	PCIE_RXP12	C22	D77	RSVD	RSVD	C77
D23	PCIE_TXN12	PCIE_RXN12	C23	D78	PEG_TXP8	PEG_RXP8	C78
D24	RSVD	DPB_HPD	C24	D79	PEG_TXN8	PEG_RXN8	C79
D25	RSVD	N/C	C25	D80	GND (FIXED)	GND (FIXED)	C80
D26	DDI2_PAIR_0	N/C	C26	D81	PEG_TXP9	PEG_RXP9	C81
D27	DDI2_PAIR_0#	RSVD	C27	D82	PEG_TXN9	PEG_RXN9	C82
D28	RSVD	RSVD	C28	D83	RSVD	RSVD	C83
D29	DDI2_PAIR_1	N/C	C29	D84	GND	GND	C84
D30	DDI2_PAIR_1#	N/C	C30	D85	PEG_TXP10	PEG_RXP10	C85
D31	GND(FIXED)	GND (FIXED)	C31	D86	PEG_TXN10	PEG_RXN10	C86
D32	DDI2_PAIR_2	DDI3_CLK_AUX	C32	D87	GND	GND	C87
D33	DDI2_PAIR_2#	DDI3_DATA_AUX	C33	D88	PEG_TXP11	PEG_RXP11	C88
D34	DDI2_DDC_AUX_SEL	DDI3_DDC_AUX_SEL	C34	D89	PEG_TXN11	PEG_RXN11	C89
D35	RSVD	RSVD	C35	D90	GND (FIXED)	GND (FIXED)	C90
D36	DDI2_PAIR_3	N/C	C36	D91	PEG_TXP12	PEG_RXP12	C91
D37	DDI2_PAIR_3#	N/C	C37	D92	PEG_TXN12	PEG_RXN12	C92
D38	RSVD	N/C	C38	D93	GND	GND	C93
D39	DDI3_PAIR_0	N/C	C39	D94	PEG_TXP13	PEG_RXP13	C94
D40	DDI3_PAIR_0#	N/C	C40	D95	PEG_TXN13	PEG_RXN13	C95
D41	GND(FIXED)	GND(FIXED)	C41	D96	GND	GND	C96
D42	DDI3_PAIR_1	N/C	C42	D97	RSVD	RSVD	C97
D43	DDI3_PAIR_1#	N/C	C43	D98	PEG_TXP14	PEG_RXP14	C98
D44	DPC_HPD	N/C	C44	D99	PEG_TXN14	PEG_RXN14	C99
D45	RSVD	RSVD	C45	D100	GND (FIXED)	GND (FIXED)	C100
D46	DDI3_PAIR_2	N/C	C46	D101	PEG_TXP15	PEG_RXP15	C101
D47	DDI3_PAIR_2#	N/C	C47	D102	PEG_TXN15	PEG_RXN15	C102
D48	RSVD	RSVD	C48	D103	GND	GND	C103
D49	DDI3_PAIR_3	N/C	C49	D104	VCC_12V	VCC_12V	C104
D50	DDI3_PAIR_3#	N/C	C50	D105	VCC_12V	VCC_12V	C105
D51	GND (FIXED)	GND (FIXED)	C51	D106	VCC_12V	VCC_12V	C106
D52	PEG_TXP0	PEG_RXP0	C52	D107	VCC_12V	VCC_12V	C107
D53	PEG_TXN0	PEG_RXN0	C53	D108	VCC_12V	VCC_12V	C108
D54	CFG2	N/C	C54	D109	VCC_12V	VCC_12V	C109
D55	PEG_TXP1	PEG_RXP1	C55	D110	GND (FIXED)	GND (FIXED)	C110

This page is intentionally left blank.



Chapter 3

Installation & Maintenance

3.1 Installing the CPU Module on Carrier Board

1. Find the COM Express connectors on carrier board PBE-1705, which is available in Section [1.5.1 Optional Accessories on page 4](#).
2. Embed EmETXe-i89M3 into PBE-1705 via COM Express connectors as below; that is, COM Express AB to AB and CD to CD.

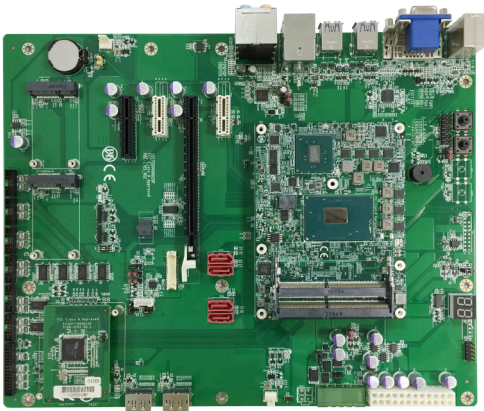
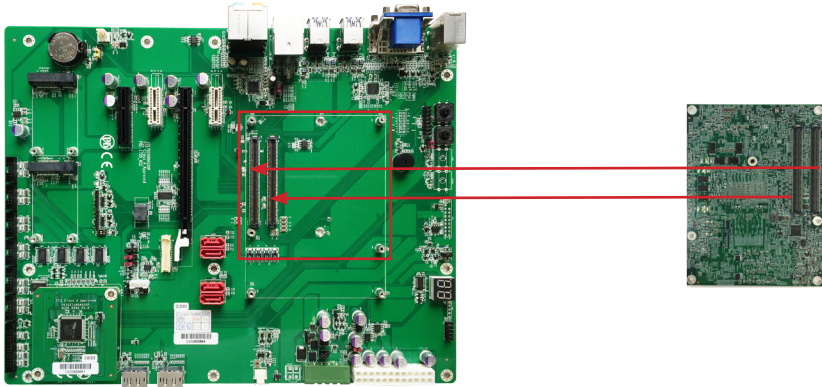

3.2 Installing the Heatsink

1. Locate EmETXe-i89M3 mounted on PBE-1705.
2. Prepare the heatspred included in optional accessories. (See section [1.5.1 Optional Accessories on page 4](#)) Put heatspred on the CPU module and lock it. Make sure thermal grease in contact with CPU and chipset on CPU module. Plug power cable into appropriate connector if there is a fan.

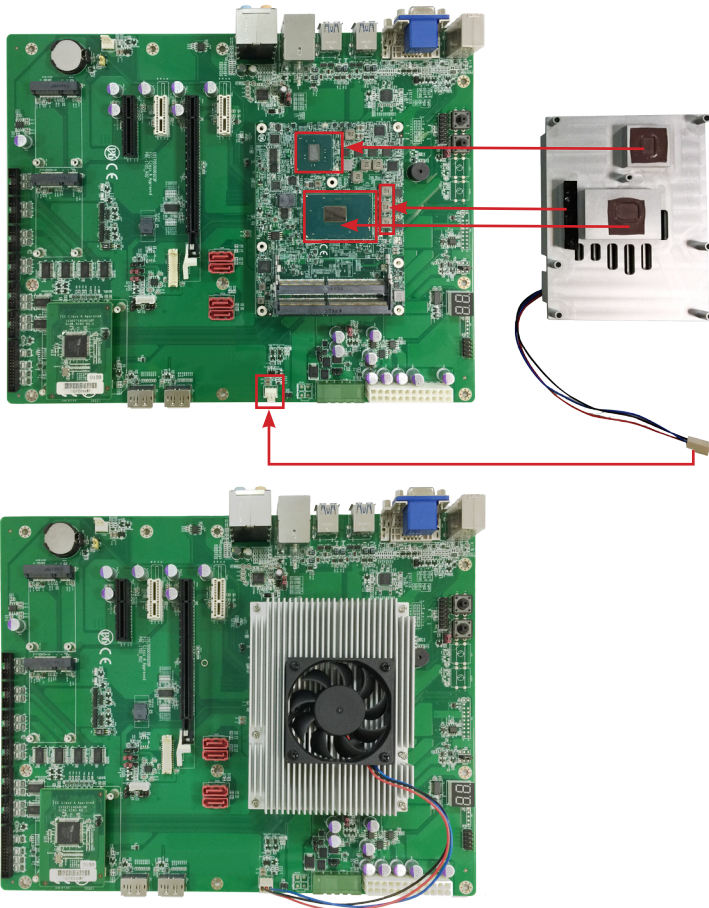

This page is intentionally left blank.



Chapter 4

BIOS

4.1 Main

The AMI BIOS provides a Setup utility program for specifying the system configurations and settings. The BIOS RAM of the system stores the Setup utility and configurations. When you turn on the computer, the AMI BIOS is immediately activated. To enter the BIOS SETUP UTILITY, press “Delete” once the power is turned on.

The **Main Setup** screen lists the following information:

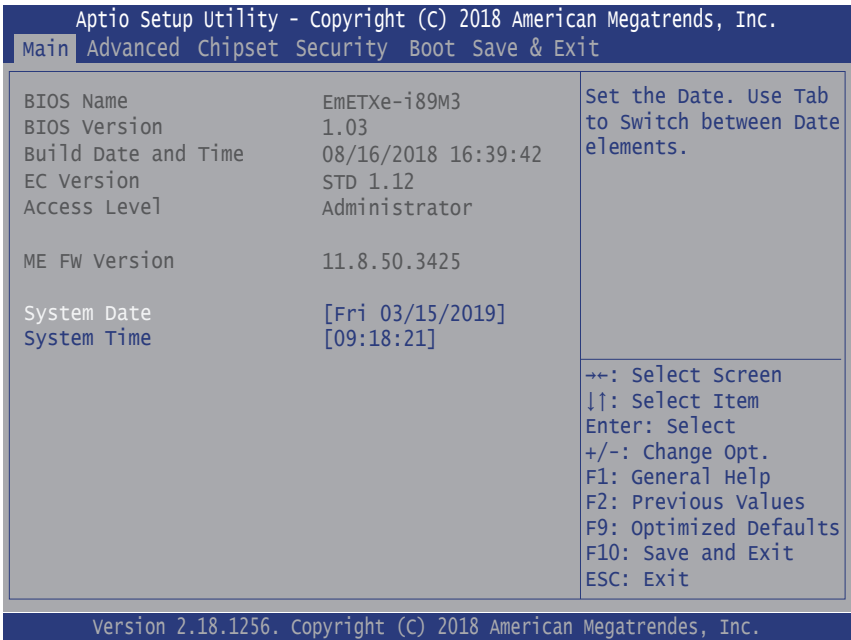

Setting	Description
System Date	<p>Set the system date. Use Tab to switch between Data elements. Note that the ‘Day’ automatically changes when you set the date.</p> <ul style="list-style-type: none"> ▶ The date format is: <ul style="list-style-type: none"> Day: Sun to Sat Month: 1 to 12 Date: 1 to 31 Year: 1998 to 2099

System Time	<p>Set the system time. Use Tab to switch between Time elements.</p> <p>▶ The time format is: Hour: 00 to 23 Minute: 00 to 59 Second: 00 to 59</p>
-------------	---

Key Commands

BIOS Setup Utility is mainly a key-based navigation interface. Please refer to the following key command instructions for navigation process.

Keystroke	Function
◀ ▶	Move to highlight a particular configuration screen from the top menu bar / Move to highlight items on the screen
▼ ▲	Move to highlight previous/next item
Enter	Select and access a setup item/field
Esc	On the Main Menu – Quit the setup and not save changes into CMOS (a message screen will display and ask you to select “OK” or “Cancel” for exiting and discarding changes. Use “←” and “→” to select and press “Enter” to confirm) On the Sub Menu – Exit current page and return to main menu
Page Up / +	Increase the numeric value on a selected setup item / make change
Page Down / -	Decrease the numeric value on a selected setup item / make change
F1	Activate “General Help” screen
F10	Save the changes that have been made in the setup and exit. (a message screen will display and ask you to select “OK” or “Cancel” for exiting and saving changes. Use “←” and “→” to select and press “Enter” to confirm)

4.2 Advanced

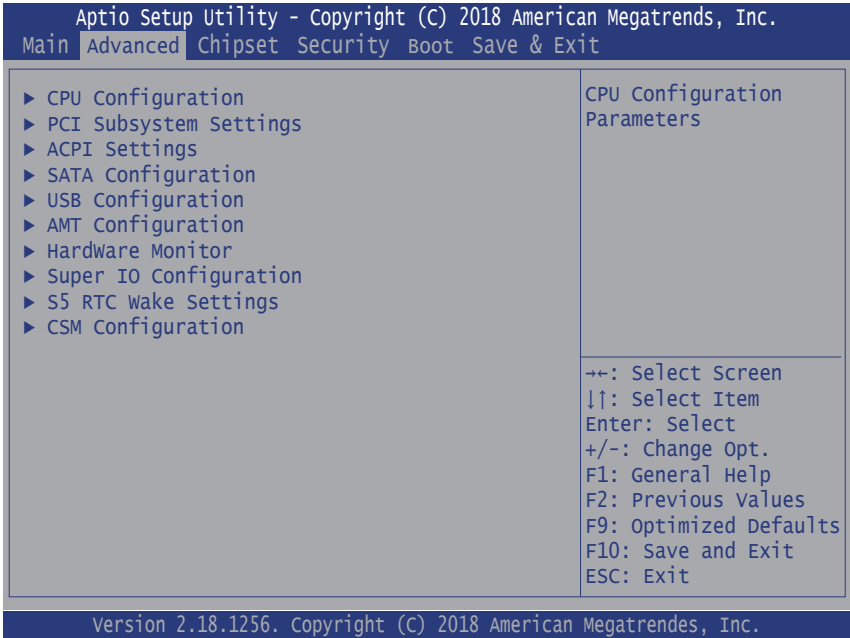

Setting	Description
CPU Configuration	See section 4.2.1 CPU Configuration on page 23
PCI Subsystem Settings	See section 4.2.2 PCI Subsystem Settings on page 25
ACPI Settings	See section 4.2.3 ACPI Settings on page 26
SATA Configuration	See section 4.2.4 SATA Configuration on page 27
USB Configuration	See section 4.2.5 USB Configuration on page 28
AMT Configuration	See section 4.2.6 AMT Configuration on page 30
Hardware Monitor	See section 4.2.7 Hardware Monitor on page 31
Super IO Configuration	See section 4.2.8 Super IO Configuration on page 32
S5 RTC Wake Settings	See section 4.2.9 S5 RTC Wake Settings on page 34
CSM Configuration	See section 4.2.10 CSM Configuration on page 35

4.2.1 CPU Configuration

Aptio Setup Utility - Copyright (C) 2018 American Megatrends, Inc.		
Advanced		
CPU Configuration		Enabled for windows XP and Linux (OS optimized for Hyper-Threading Technology) and Disabled for other OS (OS not optimized for Hyper-Threading Technology). When disabled only one thread per enabled core is enabled.
Intel(R) Core(TM) i7-6822EQ CPU @ 2.00GHZ		
CPU Signature	506E3	
Microcode Patch	8A	
Max CPU Speed	2000 MHz	
Min CPU Speed	800 MHz	
CPU Speed	2000 MHz	
Processor Cores	4	
L1 Data Cache	32 KB x 4	
L1 Code Cache	32 KB x 4	
L2 Cache	256 KB x 2	--: Select Screen ↑: Select Item Enter: Select +/-: Change Opt. F1: General Help F2: Previous Values F9: Optimized Defaults F10: Save and Exit ESC: Exit
L3 Cache	8 MB	
L4 Cache	Not Present	
Hyper-threading	[Enabled]	
Active Processor Cores	[All]	
Intel Virtualization Technology	[Enabled]	
Boot performance Mode	[Max Non-Turbo Performance]	
Intel (R) SpeedStep (tm)	[Enabled]	
Turbo Mode	[Enabled]	
CPU C states	[Disabled]	
Version 2.18.1256. Copyright (C) 2018 American Megatrends, Inc.		

Setting	Description
Hyper-threading	Enabled (default) for Windows XP and Linux (OS optimized for Hyper-Threading Technology) and Disabled for other OS (OS not optimized or Hyper-Threading Technology). When disabled only one thread per enabled core is enabled.
Active Processor Cores	Number of cores to enable in each processor package. ► Options: All (default), 1 , 2 and 3 .
Intel Virtualization Technology	When enabled, a VMM can utilize the additional hardware capabilities provided by Vanderpool Technology ► Options: Enabled (default) or Disabled

Boot performance Mode	Set the performance state that the BIOS will set before the OS handoff. ▶ Options: Max Battery , Max Non-Turbo Performance (default) and Turbo Performance .
Intel (R) Speed Step (tm)	Enable (default)/ Disable Intel SpeedStep
Turbo Mode	Only available when Intel Speed Step is Enabled . Enable (default)/ Disable Turbo Mode
CPU C States	Enable /Disable (default) CPU C States

4.2.2 PCI Subsystem Settings

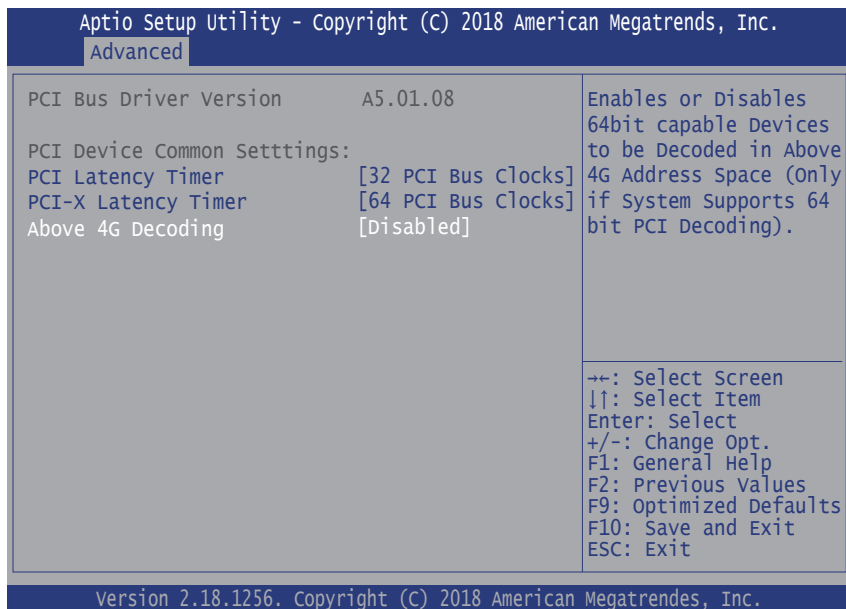

Setting	Description
PCI Latency Timer	Value to be programmed into PCI Latency Timer Register. ▶ 32 (default), 64, 96, 128, 160, 192, 224 and 248 PCI Bus Clocks.
PCI-X Latency Timer	Value to be programmed into PCI-X Latency Timer Register. ▶ 32, 64 (default), 96, 128, 160, 192, 224 and 248 PCI Bus Clocks.
Above 4G Decoding	Enable/Disable (default) 64bit capable Devices to be Decoded in Above 4G Address Space (Only if System Supports 64 bit PCI Decoding).

4.2.3 ACPI Settings

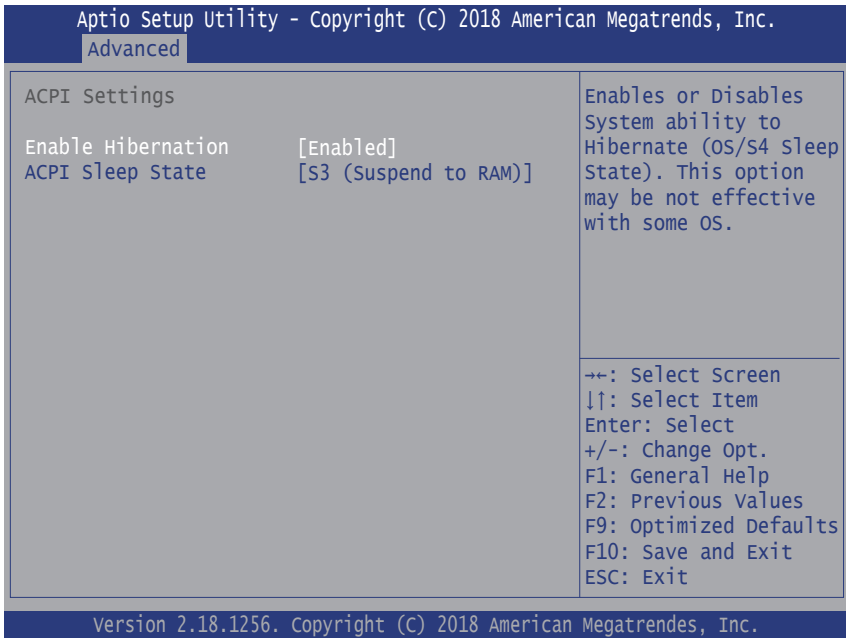

Setting	Description
Enable Hibernation	Enable (default) or Disable System ability to Hiber-nate (OS/S4 Sleep State). This option may be not effective with some OS.
ACPI Sleep State	Select the highest ACPI sleep state the system will enter when the SUSPEND button is pressed. ► Options: Suspend Disabled and S3 (Suspend to RAM) (default).

4.2.4 SATA Configuration

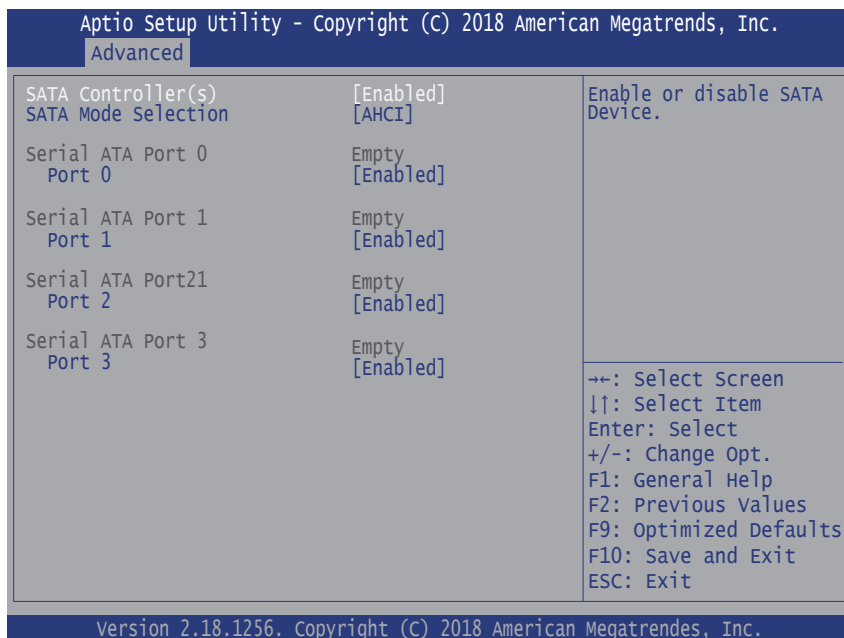

Setting	Description
SATA Controller(s)	Enable (default) or disable SATA Device.
SATA Mode Selection	Determines how SATA controller(s) operate. ► Options: AHCI (default) and RAID
Port 0/1/2/3	Enable (default) or disable SATA Port.

4.2.5 USB Configuration

Aptio Setup Utility - Copyright (C) 2018 American Megatrends, Inc.
 Advanced

USB Configuration		Enables Legacy USB support. AUTO option disables legacy support if no USB devices are connected. DISABLE option will keep USB devices available only for EFI applications.
USB Module Version	14	
USB Devices:	1 XHCI	
USB Devices:	1 Keyboard	
Legacy USB Support	[Enabled]	
XHCI Hand-off	[Enabled]	
USB Mass Storage Driver Support	[Enabled]	
Port 60/64 Emulation	[Disabled]	
USB hardware delays and time-outs:		
USB Transfer time-out	[20 sec]	
Device reset time-out	[20 sec]	
Device power-up delay	[Auto]	

→+: Select Screen
 ↓↑: Select Item
 Enter: Select
 +/-: Change Opt.
 F1: General Help
 F2: Previous Values
 F9: Optimized Defaults
 F10: Save and Exit
 ESC: Exit

Version 2.18.1256. Copyright (C) 2018 American Megatrends, Inc.

Setting	Description
Legacy USB Support	Sets legacy USB support. ► Options: Enabled (default), Disabled and Auto . AUTO option disables legacy support if no USB devices are connected. Disable option will keep USB devices available only for EFI applications.
XHCI Hand-off	Enable (default) or Disable XHCI Hand-off This is a workaround for OSeS without XHCI hand-off support. The XHCI ownership change should be claimed by XHCI driver.
USB Mass Storage Driver Support	Enable (default) or Disable USB Mass Storage Driver Support.

Port 60/64 Emulation	Enable or Disable (default) I/O port 60h/64h emulation support. This should be enabled for the complete USB keyboard legacy support for non-USB aware OSes.
USB hardware delay and time-out	
USB Transfer time-out	Use this item to set the time-out value for control, bulk, and interrupt transfers. <ul style="list-style-type: none"> Options available are: 1 sec, 5 sec, 10 sec, 20 sec (default)
Device reset time-out	Use this item to set USB mass storage device start unit command time-out. <ul style="list-style-type: none"> Options available are: 10 sec, 20 sec (default), 30 sec, 40 sec
Device power-up delay	Use this item to set maximum time the device will take before it properly reports itself to the host controller. <ul style="list-style-type: none"> Options available are: <p>Auto (Default): 'Auto' uses default value: for a root port it is 100 ms, for a hub port the delay is taken from hub descriptor.</p> <p>Manual: Select Manual you can set value for the following sub-item: 'Device Power-up delay in seconds', the delay range in from 1 to 40 seconds, in one second increments.</p>

4.2.6 AMT Configuration

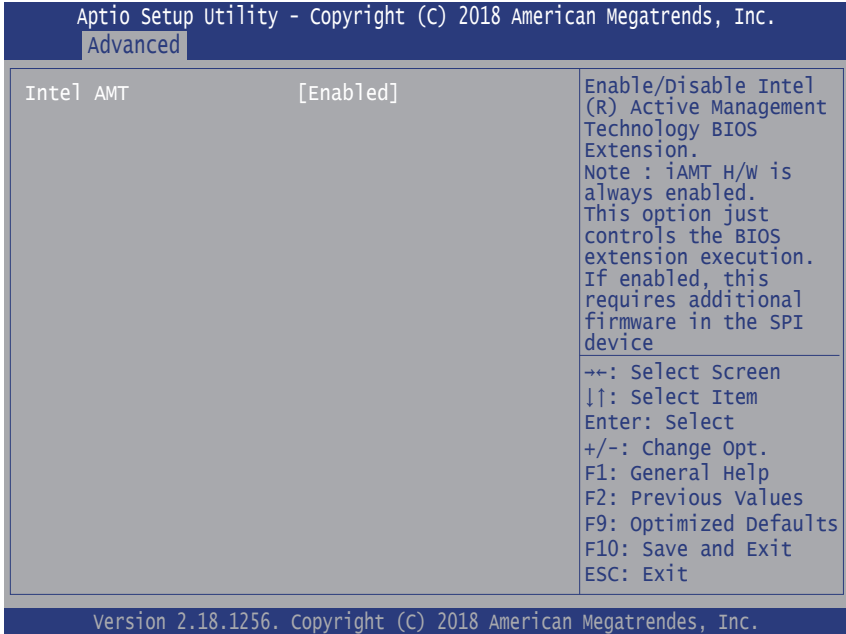

Setting	Description
Intel AMT	Enable (default) / Disable Intel(R)Active Management Technology BIOS Extension. Note : iAMT H/W is always enabled. This option just controls the BIOS extension execution. If enabled, this requires additional firmware in the SPI device.

4.2.7 Hardware Monitor

Aptio Setup Utility - Copyright (C) 2018 American Megatrends, Inc.

Advanced

PC Health Status

CPU Temperature	: +37°C
Fan1 Speed	: 4607 RPM
VCORE	: +0.858 V
VCCDU	: +1.189 V
VIN	: +11.942 V

→: Select Screen
↓↑: Select Item
Enter: Select
+/-: Change Opt.
F1: General Help
F2: Previous Values
F9: Optimized Defaults
F10: Save and Exit
ESC: Exit

Version 2.18.1256. Copyright (C) 2018 American Megatrends, Inc.

Access this submenu to monitor the hardware status.

4.2.8 Super IO Configuration

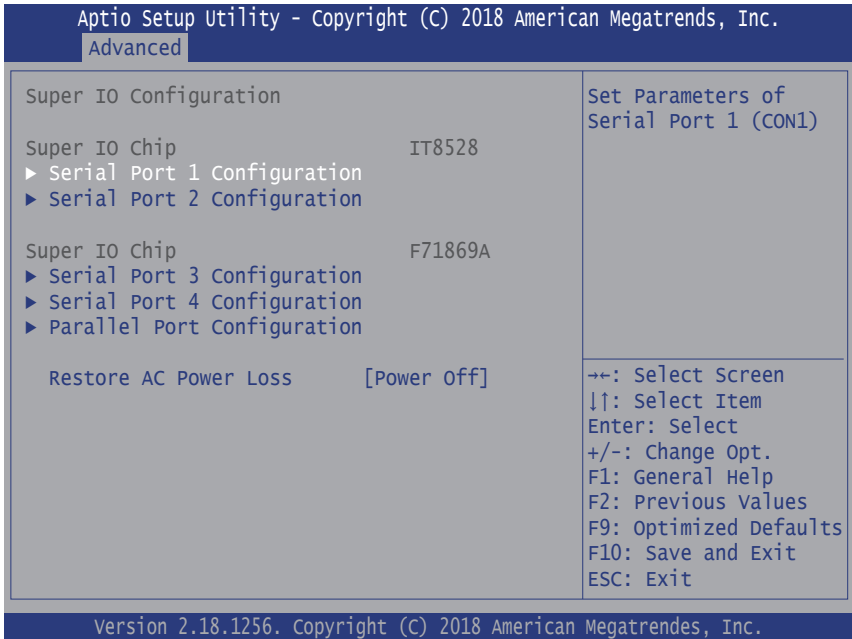

Setting	Description
Serial Port 1/2/3/4 & Parallel Port Configuration	See next page.
Restore AC Power Loss	Specify what state to go to when power is re-applied after a power failure. ▶ Options: Last State , Power On and Power Off (default)

Serial Port 1/2/3/4 Configuration

Setting	Description
Serial Port	Enable (default) or Disable Serial Port (COM).
Change Settings	<p>Select an optimal setting for Super IO device.</p> <ul style="list-style-type: none"> ▶ Options for Serial Port 1: <ul style="list-style-type: none"> Auto; IO=3F8h; IRQ=4 (default) ; IO=3F8h; IRQ=3, 4, 7, 12; IO=2F8h; IRQ=3, 4, 7, 12; ▶ Options for Serial Port 2: <ul style="list-style-type: none"> Auto IO=2F8h; IRQ=3 (default) IO=3F8h; IRQ=3, 4, 7, 12 IO=2F8h; IRQ=3, 4, 7, 12 ▶ Options for Serial Port 3: <ul style="list-style-type: none"> Auto IO=3E8h; IRQ=11 (default) IO=3E8h; IRQ=7, 10, 11, 12 IO=2E8h; IRQ=7, 10, 11, 12 IO=2F0h; IRQ=7, 10, 11, 12 IO=2E0h; IRQ=7, 10, 11, 12 ▶ Options for Serial Port 4: <ul style="list-style-type: none"> Auto IO=2E8h; IRQ=10 (default) IO=3E8h; IRQ=7, 10, 11, 12 IO=2E8h; IRQ=7, 10, 11, 12 IO=2F0h; IRQ=7, 10, 11, 12 IO=2E0h; IRQ=7, 10, 11, 12

Parallel Port Configuration

Setting	Description
Parallel Port	Enable (default) or Disable Parallel Port (LPT/LPTE).
Change Settings	Select an optimal setting for Super IO device. <ul style="list-style-type: none"> ▶ Options: <ul style="list-style-type: none"> Auto IO=378h; IRQ=7 (default) IO=378h; IRQ=7, 10, 11, 12 IO=278h; IRQ=7, 10, 11, 12 IO=3BCh; IRQ=7, 10, 11, 12
Device Mode (only for Parallel Port Configuration)	Change the Printer Port mode. <ul style="list-style-type: none"> ▶ Options: <ul style="list-style-type: none"> STD Printer Mode (default) SPP Mode EPP-1.9 and SPP Mode EPP-1.7 and SPP Mode ECP Mode ECP and EPP 1.9 Mode ECP and EPP 1.7 Mode.

4.2.9 S5 RTC Wake Settings

Setting	Description
Wake System from S5	Enable or Disable (default) system wake on alarm event. <ul style="list-style-type: none"> ▶ Options available are: <ul style="list-style-type: none"> Disabled (default): Fixed Time: System will wake on the hr::min::sec specifiedc. DynamicTime: If selected, you need to set Wake up minute increase from 1 - 5. System will wake on the current time + increase minute(s).

4.2.10 CSM Configuration

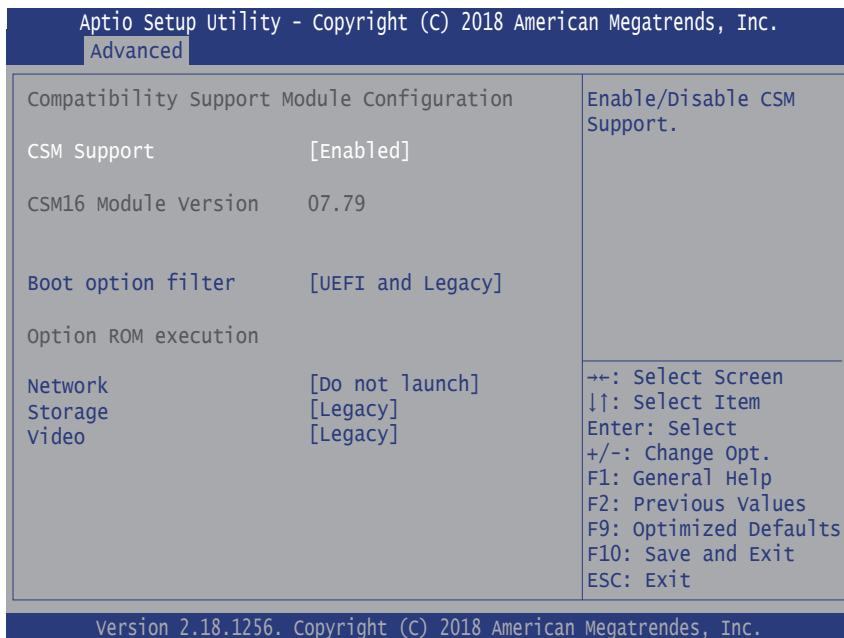

Setting	Description
CSM Support	Enable (default) or Disable CSM Support.
Boot option filter	Control the Legacy/UEFI ROMs priority. ▶ Options: UEFI and Legacy (default), Legacy only , UEFI only
Network	Control the execution of UEFI and Legacy PXE OpROM ▶ Options: Do not launch (default) and Legacy
Storage	Control the execution of UEFI and Legacy Storage OpROM ▶ Options: Do not launch and Legacy (default)
Video	Control the execution of UEFI and Legacy Video OpROM ▶ Options: UEFI and Legacy (default)

4.3 Chipset

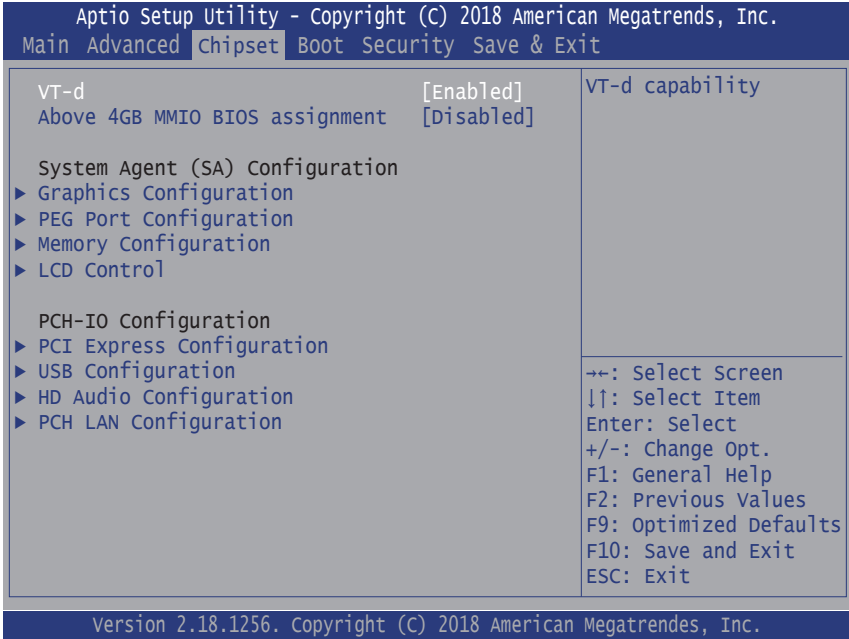

Setting	Description
VT-d	Enable (default) or Disable VT-d function
Above 4GB MMIO BIOS assignment	Enable or Disable (default) Above 4GB MMIO BIOS assignment
System Agent (SA) Configuration	
Graphics Configuration	See section 4.3.1 Graphics Configuration on page 38
PEG Port Configuration	See section 4.3.2 PEG Port Configuration on page 40
Memory Configuration	See section 4.3.3 Memory Configuration on page 41
LCD Control	See section 4.3.4 LCD Control on page 42

PCH-IO Configuration	
PCI Express Configuration	See section 4.3.5 PCI Express Configuration on page 43
USB Configuration	See section 4.3.6 USB Configuration on page 44
HD Audio Configuration	Control Detection of the HD-Audio device. ▶ Options available are: Disabled: HDA will be unconditionally disabled Enabled: HDA will be unconditionally Enabled Auto (default) = HDA will be enabled if present, disabled otherwise.
PCH LAN Controller	Enables/Disables onboard NIC. ▶ Options: Enabled (default) and Disabled If enabled, "Wake on LAN" option will be available to Enable (default) / Disable integrated LAN to wake the system. (the Wake On LAN cannot be disabled if ME is on at Sx state.)

4.3.1 Graphics Configuration

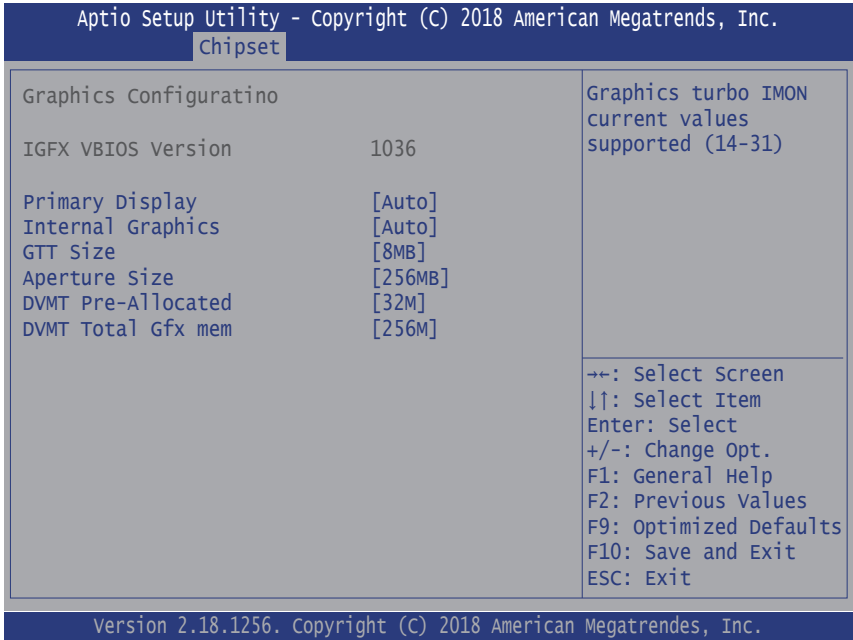

Setting	Description
Primary Display	Select which of IGFX/PEG/PCI Graphics device should be Primary Display or select SG for Switchable Gfx. ► Options available are Auto (default), IGFX and PEG.
Internal Graphics	Keep IGD enabled based on the setup options. ► Options: Auto (default), Disabled and Enabled .
GTT Size	Select the GTT Size. ► Options: 4MB , 2MB and 8MB (default).

Aperture Size	<p>Select the Aperture Size. Note that above 4GB MMIO BIOS assignment is automatically enabled when selecting 2048MB aperture. To use this feature, please disable CSM support.</p> <ul style="list-style-type: none">▶ Options: 128MB, 256MB (default), 512MB, 1024MB, 2048MB and 4096MB.
DVMT Pre-Allocated	<p>Select the DVMT 5.0 Pre-allocated (Fixed) Graphic Memory size used by the Internal Graphic Device.</p> <ul style="list-style-type: none">▶ Options: 32M is the default.
DVMT total Gfx Mem	<p>Select the DVMT 5.0 Total Graphic Memory size used by the Internal Graphic Device.</p> <ul style="list-style-type: none">▶ Options: 128MB, 256MB (default) and Max.

4.3.2 PEG Port Configuration

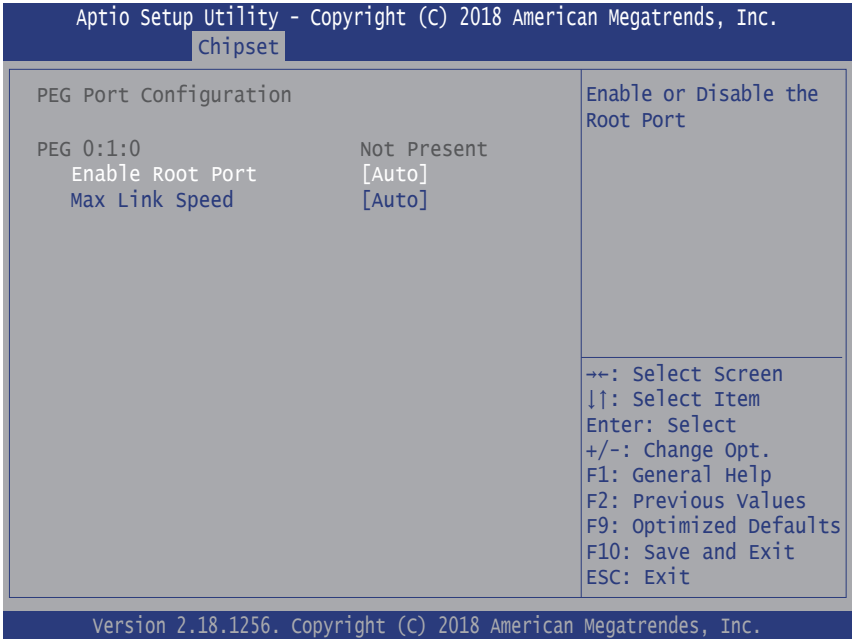

Setting	Description
Enable Root Port	Enable or Disable the Root Port. The default is Auto .
Max Link Speed	Configures PEG 0:1:0 Max Speed. ▶ Options: Auto (default), Gen1 , Gen2 and Gen3 .

4.3.3 Memory Configuration

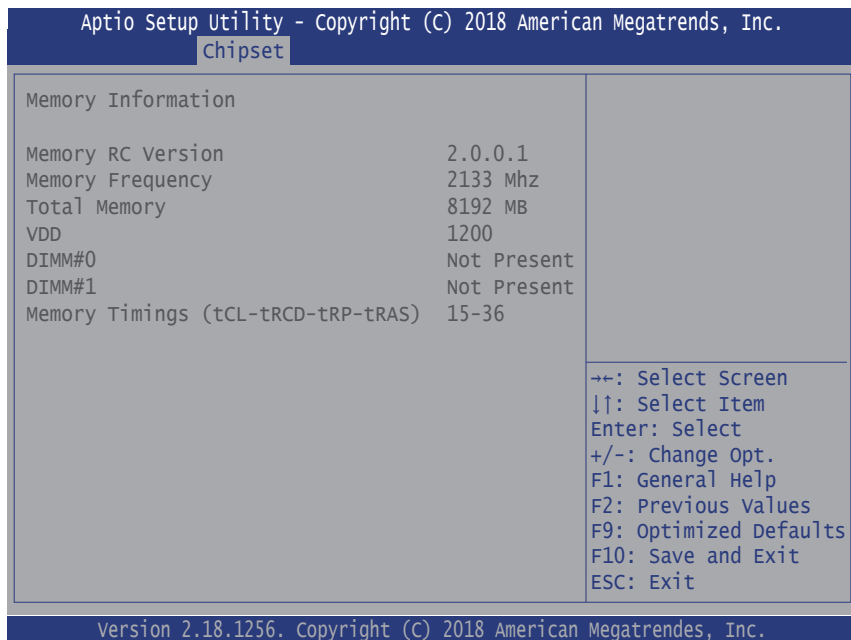

Access this submenu to view the memory configuration.

4.3.4 LCD Control

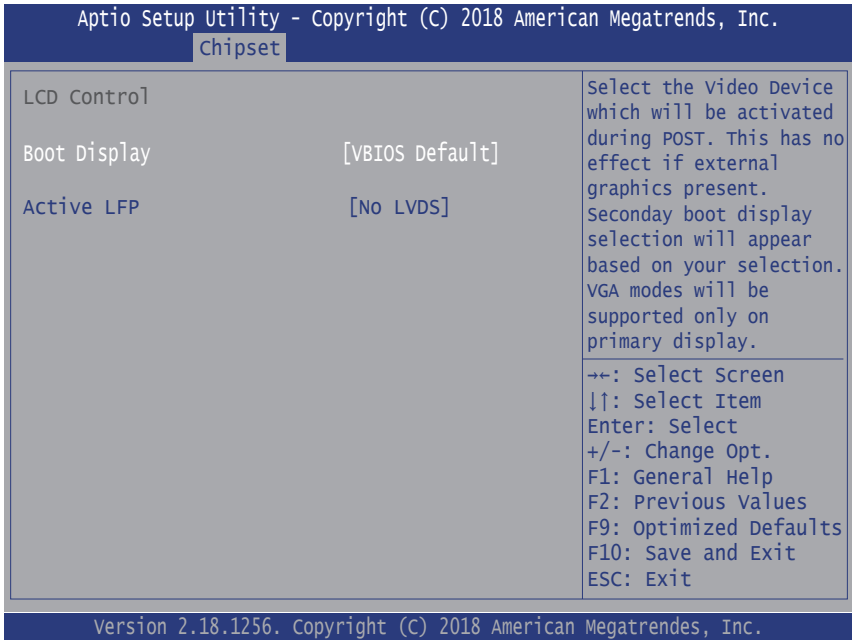

Setting	Description
Boot Display	Select the Video Device which will be activated during POST. This has no effect if external graphics present. Secondary boot display selection will appear based on your selection. VGA modes will be supported only on primary display. ► Options: VBIOS Default (default), CRT , LFP , DP1 and DVI .
Active LFP	Configuring LFP usage ► Options: No LVDS (default), and eDP Port-A

4.3.5 PCI Express Configuration

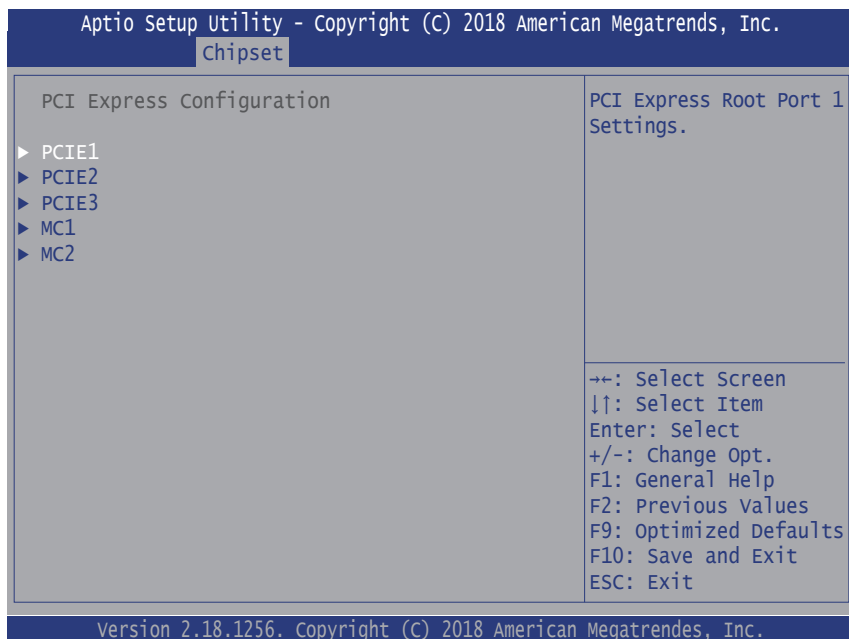

Setting	Description
PCI Express Root Port	Enable (default) or disable PCI Express Root Port.
ASPM Support	Disable or set the ASPM level. Force L0s will force all inks to L0s state. "Auto" will allow BIOS to auto configure."Disable" will disable ASPM. ▶ Options: Disabled (default), L0s , L1 , L0sL1 and Auto .
PCIe Speed	Select PCI Express port speed. ▶ Options: Auto (default), Gen1 , Gen2 and Gen3

4.3.6 USB Configuration

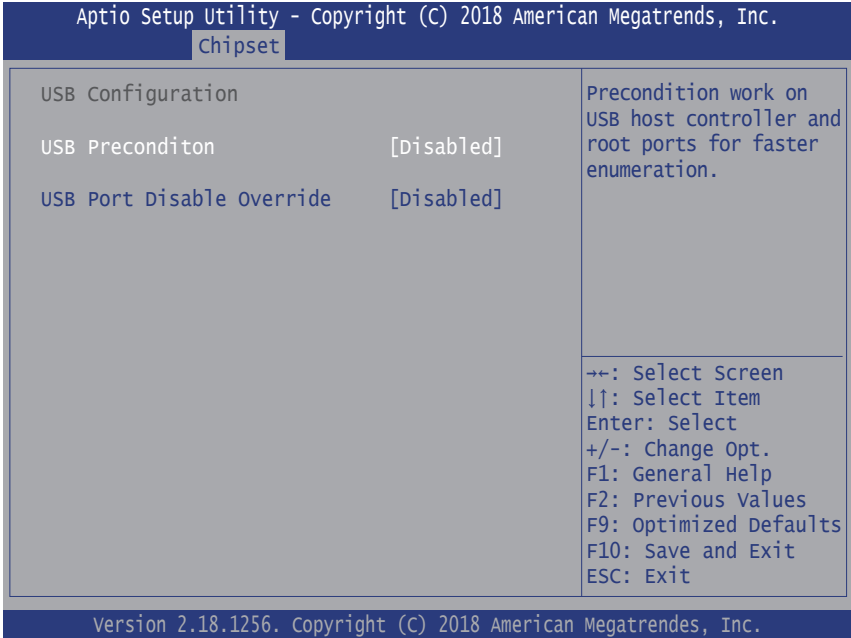

Setting	Description
USB Precondition	Precondition work on USB host controller and root ports for faster enumeration. ► Options: Enable/Disable (default).
USB Port Disable Override	Selectively enable/disable the corresponding USB port from reporting a Device Connection to the controller. Options are Disabled (default) / Select Per-Pin .

4.4 Security

The **Security** menu sets up the administrator password.

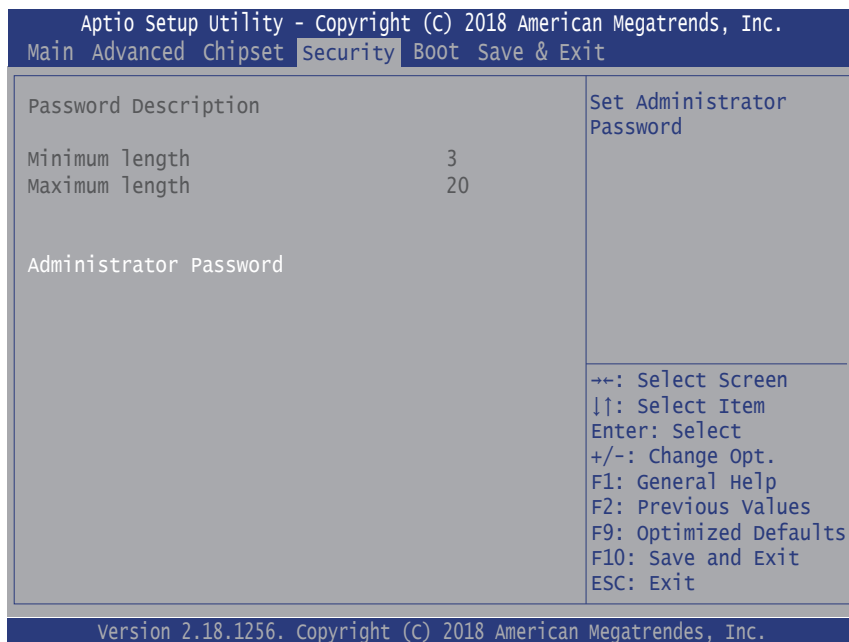

Setting	Description
Administrator Password	<p>To set up an administrator password:</p> <ol style="list-style-type: none"> 1. Select Administrator Password. The screen then pops up an Create New Password dialog. 2. Enter your desired password that is no less than 3 characters and no more than 20 characters. 3. Hit [Enter] key to submit.

4.5 Boot

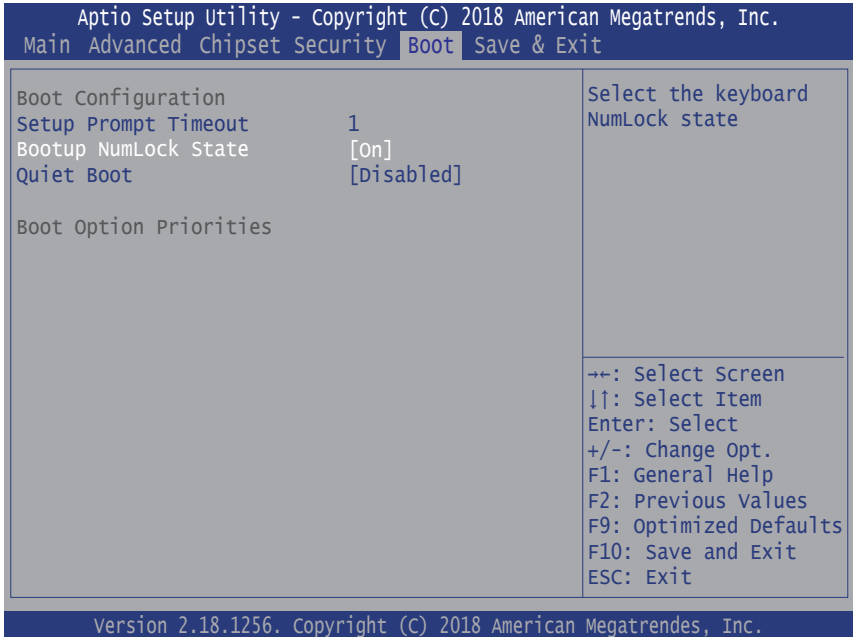

Setting	Description
Setup Prompt Timeout	Number of seconds to wait for setup activation key. 65535 (0xFFFF) means indefinite waiting.
Boot NumLock State	Select the keyboard NumLock state. ► Options: On (default) and Off .
Quiet Boot	Enable or Disable (default) Quiet Boot option.

4.6 Save & Exit

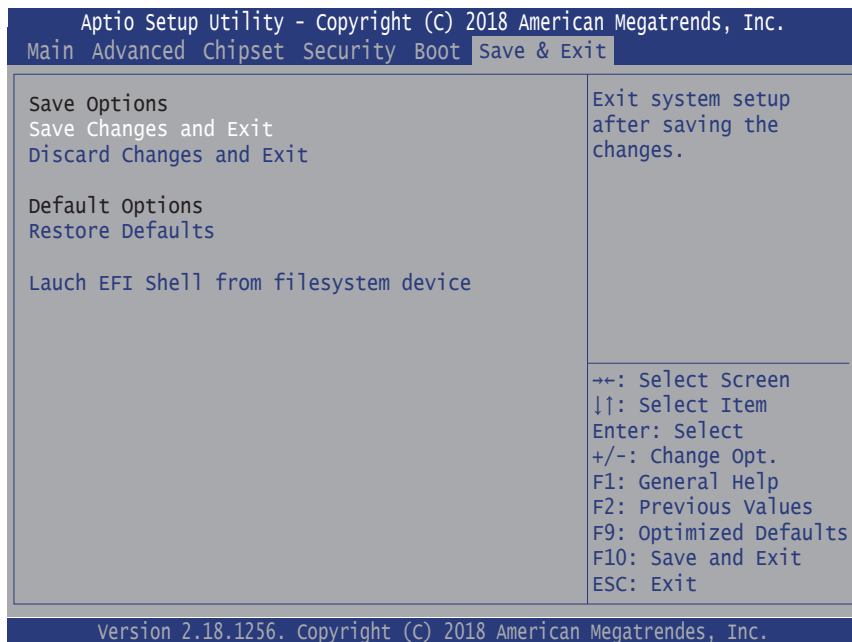

Setting	Description
Save Changes and Exit	Exit system setup after saving the changes. ► Enter the item and then a dialog box pops up: Save configuration and exit? (Yes/ No)
Discard Changes and Exit	Exit system setup without saving the changes. ► Enter the item and then a dialog box pops up: Quit without saving? (Yes/ No)
Restore Defaults	Restore/Load Default values for all the setup options. ► Enter the item and then a dialog box pops up: Load Optimized Defaults? (Yes/ No)
Launch EFI Shell from filesystem device	Attempts to launch EFI shell application (Shell.efi) from one of the available filesystem devices.



Appendix

Appendix A: I/O Port Address Map

Each peripheral device in the system is assigned a set of I/O port addresses which also becomes the identity of the device. The following table lists the I/O port addresses used.

Address	Device Description
03F8-03FF	Communications Port (COM1)
02F8-02FF	Communications Port (COM2)
03E8-03EF	Communications Port (COM3)
02E8-02EF	Communications Port (COM4)
002E-002F	Motherboard resources
004E-004F	Motherboard resources
0061-0061	Motherboard resources
0070-0071	Motherboard resources
0080-0080	Motherboard resources
0092-0092	Motherboard resources
00B2-00B3	Motherboard resources
1800-18FE	Motherboard resources
0A00-0A1F	Motherboard resources
0A20-0A2F	Motherboard resources
0A30-0A3F	Motherboard resources
0CF8-0CFF	PCI Express Configuration Access Port
0378-037F	Printer Port (LPT1)
0020-0021	Programmable interrupt controller
00A0-00A1	Programmable interrupt controller
04D0-04D1	Programmable interrupt controller
F040-F05F	SM Bus Controller
F090-F097	Standard SATA AHCI Controller
F080-F083	Standard SATA AHCI Controller
F060-F07F	Standard SATA AHCI Controller
0040-0043	System timer

Appendix B: BIOS Memory Mapping

Address	Device Description
0xDF000000-0xDF01FFFF	Ethernet Controller
0xDF040000-0xDF043FFF	High Definition Audio Controller
0xDF020000-0xDF02FFFF	High Definition Audio Controller
0xFED00000-0xFED003FF	High Precision Event Timer
0xFF000000-0xFFFFFFFF	Intel(R) 82802 Firmware Hub Device
0xDF030000-0xDF03FFFF	Intel(R) USB 3.0 eXtensible Host Controller - 0100 (Microsoft)
0xA0000-0xBFFFF	Microsoft Basic Display Adapter
0xDE000000-0xDEFFFFFF	Microsoft Basic Display Adapter
0xC0000000-0xCFFFFFFF	Microsoft Basic Display Adapter
0xFED10000-0xFED17FFF	Motherboard resources
0xFED18000-0xFED18FFF	Motherboard resources
0xFED19000-0xFED19FFF	Motherboard resources
0xE0000000-0xEFFFFFFF	Motherboard resources
0xFED20000-0xFED3FFFF	Motherboard resources
0xFED90000-0xFED93FFF	Motherboard resources
0xFED45000-0xFED8FFFF	Motherboard resources
0xFF000000-0xFFFFFFFF	Motherboard resources
0xFEE00000-0xFEEFFFFFFF	Motherboard resources
0xDFFE0000-0xDFFFFFFF	Motherboard resources
0xFE029000-0xFE029FFF	Motherboard resources
0xFE028000-0xFE028FFF	Motherboard resources
0xFDAF0000-0xFDAFFFFF	Motherboard resources
0xFDAE0000-0xFDAEFFFF	Motherboard resources
0xFDAC0000-0xFDACFFFF	Motherboard resources
0xFD000000-0xFDABFFFF	Motherboard resources
0xFDAD0000-0xFDADFFFF	Motherboard resources
0xFDB00000-0xFDFFFFFFFF	Motherboard resources
0xFE000000-0xFE01FFFF	Motherboard resources

0xFE036000-0xFE03BFFF	Motherboard resources
0xFE03D000-0xFE3FFFFFF	Motherboard resources
0xFE410000-0xFE7FFFFFF	Motherboard resources
0xDF051000-0xDF051FFF	PCI Data Acquisition and Signal Processing Controller
0xFD000000-0xFDABFFFF	PCI Express Root Complex
0x90000000-0xDFFFFFFF	PCI Express Root Complex
0xDF044000-0xDF047FFF	PCI Memory Controller
0xDF04B000-0xDF04BFFF	SDA Standard Compliant SD Host Controller
0xDF04A000-0xDF04A0FF	SM Bus Controller
0xDF048000-0xDF049FFF	Standard SATA AHCI Controller
0xDF04E000-0xDF04E0FF	Standard SATA AHCI Controller
0xDF04D000-0xDF04D7FF	Standard SATA AHCI Controller
0xFED40000-0xFED40FFF	Trusted Platform Module 1.2

Appendix C: Interrupt Request Lines (IRQ)

Peripheral devices use interrupt request lines to notify CPU for the service required. The following table shows the IRQ used by the devices on board.

Level	Function
IRQ0	System timer
IRQ1	PS/2 Keyboard
IRQ3	Communications Port (COM2)
IRQ4	Communications Port (COM1)
IRQ5	SM Bus Controller
IRQ8	System CMOS/real time clock
IRQ10	Communications Port (COM4)
IRQ11	Communications Port (COM3)
IRQ12	PS/2 Mouse
IRQ16~IRQ23	PCIe Devices

Appendix D: Watchdog Timer (WDT) Setting

WDT is widely used for industry application to monitor the activity of CPU. Application software depends on its requirement to trigger WDT with adequate timer setting. Before WDT time out, the functional normal system will reload the WDT. The WDT never time out for a normal system. The WDT will not be reloaded by an abnormal system, then WDT will time out and reset the system automatically to avoid abnormal operation.

This board supports 255 levels watchdog timer by software programming I/O ports. Below are the source codes written in C, please take them as WDT application example.

```
#include <math.h>
#include <stdio.h>
#include <dos.h>

int WDTCount;

int main(void)
{
    unsigned char    iCount;

    printf("WDT Times ( 1 ~ 255 ) : ");
    scanf("%d",&iCount);
    printf("\n");

    WDT_Start(iCount);

    return 0;
}

void WDT_Start(int iCount)
{
    outportb(0x66,0xBA);                /* Enable Watch Dog */
    delay(1000);

    WDTCount = iCount;
    outportb(0x62, WDTCount);          /* Number is Watch Dog Down count number */
    delay(1000);

    outportb(0x62, 0x00);              /* Minute is 1 count unit by minute */
                                        /* Minute is 0 count unit by second */
}

void WDT_Stop(void)
{
    outportb(0x66,0xBB);                /* Disable Watch Dog */
}

void WDT_Clear(void)
{

```

Appendix

```
outportb(0x66,0xBA);           /* Enable Watch Dog */
delay(1000);

outportb(0x62, WDTCount);     /* Number is Watch Dog Down count number */
delay(1000);

outportb(0x62, 0x00);         /* Minute is 1 count unit by minute */
                               /* Minute is 0 count unit by second */
}
```

Appendix E: DIO Sample Code

```
#include "math.h"
#include "stdio.h"
#include "dos.h"

int SMB_PORT_AD    = 0xF040;
int SMB_DEVICE_ADD = 0x42;

void GPIOMode(int iMode);
void GPIOData(int iData);
int  GPIOStatus();

int main(void)
{
    int iInput;

    GPIOMode(0xF);
    delay(2000);

    GPIOData(0x0A);
    delay(2000);
    iInput = GPIOStatus();
    printf(" Data : %2x \n",iInput);

    GPIOData(0x05);
    delay(2000);
    iInput = GPIOStatus();
    printf(" Data : %2x \n",iInput);

    return 0;
}

void GPIOMode(int iMode)
{
    SMB_Byte_WRITE(SMB_PORT_AD,SMB_DEVICE_ADD,0x03,iMode);    /* DIO 0 ~ 7 Mode */
}

void GPIOData(int iData)
{
    SMB_Byte_WRITE(SMB_PORT_AD,SMB_DEVICE_ADD,0x01,iData);    /* DIO 0 ~ 7 Data */
}

int GPIOStatus()
{
    int iStatus;

    iStatus = SMB_Byte_READ(SMB_PORT_AD,SMB_DEVICE_ADD,0x00);/* DIO 0 ~ 7 Status*/

    return iStatus;
}
```