EmETXe-i89U0

**COM Express® Compact
Type 6 CPU Module**

User's Manual

Version 1.1

2017.03



Revision History

Version	Date	Description
1.0	August, 2016	Initial release
1.1	March,2017	Modify Memory

Preface	iii
Copyright Notice.....	iii
Declaration of Conformity	iii
CE.....	iii
FCC Class B	iii
RoHS.....	iv
SVHC / REACH.....	iv
Warning	v
Replacing the Lithium Battery.....	v
Technical Support	v
Warranty	vi
Chapter 1 - Introduction	1
1.1 The Product.....	2
1.2 About This Manual.....	2
1.3 Specifications	3
1.4 Inside the Package	4
1.5 Ordering Information.....	4
1.5.1 Optional Accessories.....	5
1.6 The Installation Paths of CD Driver	5
Chapter 2 - Board Overview	7
2.1 What Is “COM Express®”?	8
2.2 Board Dimensions.....	9
2.3 Block Diagram	10
2.4 Connector Pin Definition	11
Chapter 3 - Installation & Maintenance	15
3.1 Installing the CPU Module on Carrier Board.....	16
3.2 Installing the Heatsink	17

Chapter 4 - BIOS	19
4.1 Main	20
4.2 Advanced.....	22
4.2.1 CPU Configuration	23
4.2.2 PCI Subsystem Settings	25
4.2.3 Trusted Computing.....	26
4.2.4 ACPI Settings.....	27
4.2.5 USB Configuration	28
4.2.6 AMT Configuration	30
4.2.7 SATA Configuration.....	31
4.2.8 Hardware Monitor.....	32
4.2.9 Super IO Configuration.....	33
4.2.10 S5 RTC Wake Settings	35
4.2.11 CSM Configuration	36
4.3 Chipset	37
4.3.1 PCI Express Configuration.....	39
4.3.2 Graphics Configuration	40
4.3.3 Memory Configuration	41
4.3.4 LCD Control	42
4.4 Security	43
4.5 Boot	44
4.6 Save & Exit.....	45
Appendix	46
Appendix A: I/O Port Address Map	47
Appendix B: BIOS Memory Mapping.....	48
Appendix C: Interrupt Request Lines (IRQ)	50
Appendix D: Watchdog Timer (WDT) Setting.....	51

Copyright Notice

All Rights Reserved.

The information in this document is subject to change without prior notice in order to improve the reliability, design and function. It does not represent a commitment on the part of the manufacturer.

Under no circumstances will the manufacturer be liable for any direct, indirect, special, incidental, or consequential damages arising from the use or inability to use the product or documentation, even if advised of the possibility of such damages.

This document contains proprietary information protected by copyright. All rights are reserved. No part of this manual may be reproduced by any mechanical, electronic, or other means in any form without prior written permission of the manufacturer.

Declaration of Conformity

CE

The CE symbol on your product indicates that it is in compliance with the directives of the Union European (EU). A Certificate of Compliance is available by contacting Technical Support.

This product has passed the CE test for environmental specifications when shielded cables are used for external wiring. We recommend the use of shielded cables. This kind of cable is available from ARBOR. Please contact your local supplier for ordering information.

This product has passed the CE test for environmental specifications. Test conditions for passing included the equipment being operated within an industrial enclosure. In order to protect the product from being damaged by ESD (Electrostatic Discharge) and EMI leakage, we strongly recommend the use of CE-compliant industrial enclosure products.

Warning

This is a class A product. In a domestic environment this product may cause radio interference in which case the user may be required to take adequate measures.

FCC Class B

This device complies with Part 15 of the FCC Rules. Operation is subject to the following two conditions:

- (1) This device may not cause harmful interference, and
- (2) This device must accept any interference received, including interference that may cause undesired operation.

NOTE:

This equipment has been tested and found to comply with the limits for a Class A digital device, pursuant to Part 15 of the FCC Rules. These limits are designed to provide reasonable protection against harmful interference when the equipment is operated in a commercial environment. This equipment generates, uses, and can radiate radio frequency energy and, if not installed and used in accordance with the instruction manual, may cause harmful interference to radio communications. Operation of this equipment in a residential area is likely to cause harmful interference in which case the user will be required to correct the interference at his own expense.

RoHS

ARBOR Technology Corp. certifies that all components in its products are in compliance and conform to the European Union's Restriction of Use of Hazardous Substances in Electrical and Electronic Equipment (RoHS) Directive 2002/95/EC.

The above mentioned directive was published on 2/13/2003. The main purpose of the directive is to prohibit the use of lead, mercury, cadmium, hexavalent chromium, polybrominated biphenyls (PBB), and polybrominated diphenyl ethers (PBDE) in electrical and electronic products. Member states of the EU are to enforce by 7/1/2006.

ARBOR Technology Corp. hereby states that the listed products do not contain unintentional additions of lead, mercury, hex chrome, PBB or PBDB that exceed a maximum concentration value of 0.1% by weight or for cadmium exceed 0.01% by weight, per homogenous material. Homogenous material is defined as a substance or mixture of substances with uniform composition (such as solders, resins, plating, etc.). Lead-free solder is used for all terminations (Sn(96-96.5%), Ag(3.0-3.5%) and Cu(0.5%)).

SVHC / REACH

To minimize the environmental impact and take more responsibility to the earth we live, Arbor hereby confirms all products comply with the restriction of SVHC (Substances of Very High Concern) in (EC) 1907/2006 (REACH --Registration, Evaluation, Authorization, and Restriction of Chemicals) regulated by the European Union.

All substances listed in SVHC < 0.1 % by weight (1000 ppm)

Warning

Single Board Computers and their components contain very delicate Integrated Circuits (IC). To protect the Single Board Computer and its components against damage from static electricity, you should always follow the following precautions when handling it :

1. Disconnect your Single Board Computer from the power source when you want to work on the inside.
2. Hold the board by the edges and try not to touch the IC chips, leads or circuitry.
3. Use a grounded wrist strap when handling computer components.
4. Place components on a grounded antistatic pad or on the bag that comes with the Single Board Computer, whenever components are separated from the system.

Replacing the Lithium Battery

Incorrect replacement of the lithium battery may lead to a risk of explosion.

The lithium battery must be replaced with an identical battery or a battery type recommended by the manufacturer.

Do not throw lithium batteries into the trash-can. It must be disposed of in accordance with local regulations concerning special waste.

Technical Support

If you have any technical difficulties, please consult the user's manual first at:

<http://www.arbor-technology.com/>

Please do not hesitate to call or e-mail our customer service when you still cannot find out the answer.

<http://www.arbor-technology.com/>

E-mail:info@arbor.com.tw

Warranty

This product is warranted to be in good working order for a period of two years from the date of purchase. Should this product fail to be in good working order at any time during this period, we will, at our option, replace or repair it at no additional charge except as set forth in the following terms. This warranty does not apply to products damaged by misuse, modifications, accident or disaster.

Vendor assumes no liability for any damages, lost profits, lost savings or any other incidental or consequential damage resulting from the use, misuse of, or inability to use this product. Vendor will not be liable for any claim made by any other related party.

Vendors disclaim all other warranties, either expressed or implied, including but not limited to implied warranties of merchantability and fitness for a particular purpose, with respect to the hardware, the accompanying product's manual(s) and written materials, and any accompanying hardware. This limited warranty gives you specific legal rights.

Return authorization must be obtained from the vendor before returned merchandise will be accepted. Authorization can be obtained by calling or faxing the vendor and requesting a Return Merchandise Authorization (RMA) number. Returned goods should always be accompanied by a clear problem description.



Chapter 1

Introduction

1.1 The Product

The EmETXe-i89U0 is a space-conscious CPU board of 95 mm x 95 mm to take up only small footprint in your system. By the architecture of Type 6, the board has two high-performance connectors to promise stable data passing rate. The soldered onboard 6th Generation Intel® Core™ processor, along with integrated Intel® Graphics chipset, bring LVDS, and DDI solution for most monitors or LCD video panels.

For system configuration, the board is supported by AMI UEFI BIOS. EmETXe-i89U0 is an ideal choice for some demanding industrial control and data communications by its significant processing performance, low power consumption and these features:

- Soldered onboard 6th Generation Intel® Core™ i7-6600U
- Intel I219LM PCIe GbE PHY w/ iAMT
- Dual Channels 24-bit LVDS and 2 x DDI ports
- Support 3 independent displays
- 5V~20V Wide Range Voltage Input
- Wide Range Operating Temp.: -40 ~ 85°C

1.2 About This Manual

This user's manual provides general information and installation instructions about the product. This user's manual is intended for experienced users and integrators with hardware knowledge of personal computers. If you are not sure about any description in this booklet. Please consult your vendor before further handling.

1.3 Specifications

Specifications

System	
CPU	Soldered onboard 6th Generation Intel® Core™ i7-6600U 2.6GHz (Base)/ 3.4GHz (Turbo), i5-6300U 2.3GHz (Base)/ 2.8GHz (Turbo), i3-6100U 2.3GHz (Base), Celeron® 3955U 2.3GHz (Base)
Memory	2 x DDR4 SO-DIMM sockets
BIOS	AMI UEFI BIOS
Watchdog Timer	1~255 levels reset
I/O	
USB 2.0	8 x USB 2.0 ports
USB 3.0	4 x USB SuperSpeed ports
Serial Port	2 x UART ports (RX/TX only)
Storage	2 x Serial ATA ports Soldered onboard eMMC 5.0 up to 32GB (OEM Request)
Expansion Bus	8 x PCIe x1 lanes, I2C Interface, DIO
Digital I/O	8-bit Digital Input/Output
Ethernet Chipset	1 x Intel® i219LM PCIe GbE PHY with iAMT
Audio	HD audio link
TPM Function	TPM supported (OEM request)
Display	
Graphics Chipset	Intel® HD Graphics 520/ 510
Graphics Interface	LCD: Dual Channels 24-bit LVDS
	2 x DDI ports
Mechanical & Environmental	
Power Requirement	5V~20V +/- 5% wide range voltage input, +5VSB
Power Consumption	1.96A@12V (i7-6600U typical)
Operating Temp.	-40 ~ 85°C (-40 ~ 185°F)
Operating Humidity	10 ~ 95% @ 85°C (non-condensing)
Dimension (L x W)	95 x 95 mm (3.7" x 3.7")

1.4 Inside the Package

Before you begin installing your single board, please make sure that the following materials have been shipped:



1 x EmETXe-i89U0 COM Express CPU Module



1 x Driver CD

1 x Quick Installation Guide

If any of the above items is damaged or missing, contact your vendor immediately.

1.5 Ordering Information

EmETXe-i89U0-6600U	6 th Generation Intel® Core™ i7-6600U 2.6GHz (Base) / 3.4GHz (Turbo) COM Express® Compact Type 6 WT CPU module (MOQ required)
EmETXe-i89U0-6300U	6 th Generation Intel® Core™ i5-6300U WT COM Express® Compact Type 6 CPU module (Build to order, MOQ required)
EmETXe-i89U0-6100U	6 th Generation Intel® Core™ i3-6100U WT COM Express® Compact Type 6 CPU module (Build to order, MOQ required)
EmETXe-i89U0-3955U	6 th Generation Intel® Celeron® 3955U WT COM Express® Compact Type 6 CPU module (Build to order, MOQ required)

1.5.1 Optional Accessories

HS-89U0-F2-T	Heat spreader with threaded standoffs (bore hole) (95x95x11mm)
HS-89U0-F2-NT	Heat spreader non-threaded standoffs (bore hole) (95x95x11mm)
HS-89U0-C1	Heat sink with FAN 95x95x29mm
HS-0000-W4	Universal evaluation heatsink kit w/ thermal pad (dimensions: 125x95x22mm, only used on a flat type heat spreader)
PBE-1705-F1	COM Express® Type 6 evaluation carrier board with SIO F71869ED module in ATX form factor
CBK-03-1705-00	Cable kit <ul style="list-style-type: none"> • 1 x SATA cable • 2 x COM Flat cables

1.6 The Installation Paths of CD Driver

The CPU module supports Windows 8.1 and 10. Find the necessary drivers on the CD that comes with your purchase. For different OS, the driver installation may vary slightly, but generally they are similar. **DO** install **Chipset**→**Graphic**→**Audio** before the rest to prevent errors.

Find the drivers on CD by the following paths:

Windows 8.1&10 64-bit

Driver	Path
Chipset	\\i89X\Chipset\Chipset_10.1.1.13_Public
Graphic	\\i89X\Graphic\IntelR Graphics Driver Production Version 15.40.16.64.4364
Audio	\\i89X\Audio\7687_PG436_Win10_Win8.1_WHQLx64
Ethernet	\\i89X\Ethernet
USB3.0	\\i89X\USB3.0\win8.1 64bit\Intel_USB_3.0_xHC_Adaptation_Driver_MR1_Release_1.0.1.45_PV (For Win 8.1 only)
ME	\\i89X\ME\Intel(R)_ME_11.0_Corporate_11.0.0.1202
RAID	\\i89X\RAID\Intel Rapid Storage Technology Driver 14.8.0.1042

This page is intentionally left blank.



Chapter 2

Board Overview

2.1 What Is “COM Express®”?

With more and more demands on small and embedded industrial boards, a multi-functional COM (Computer-on-Module) surfaces as a great solution.

COM Express® supports seven pin-out types applying to Basic and Extended form factors:

Module Type 1 and 10 support single connector with two rows (220 pins).

Module Type 2, 3, 4, 5 and 6 support two connectors with four rows (440 pins).

EmETXe-i89U0 is a Type-6 module.

Difference between Standard Type 6 and EmETXe-i89U0 is listed as below:

Module Type	Standard Type 6	EmETXe-i89U0
Connectors	2	2
Connector Rows	A, B, C, D	A, B, C, D
PCIe Lanes (Max)	24	8
LAN (Max)	1	1
Serial Ports (Max)	2	2
Digital Display I/F (Max)	3	2
USB 3.0 Ports (Max)	4	4

Row AB provides pins for PCI Express, SATA, LVDS, LCD channel, LPC bus, system and power management, VGA, LAN, and power and ground interfaces.

Row CD provides SDVO and legacy PCI signals next to additional PCI Express, LAN and power and ground signals. The COM are targeted at following applications:

- Retail & Advertising
- Medical
- Test & Measurement
- Gaming & Entertainment
- Industrial & Automation
- Military & Government
- Security

2.2 Board Dimensions

The following illustration shows the dimension of EmETXe-i89U0, with the measurements in width, depth, and height called out.

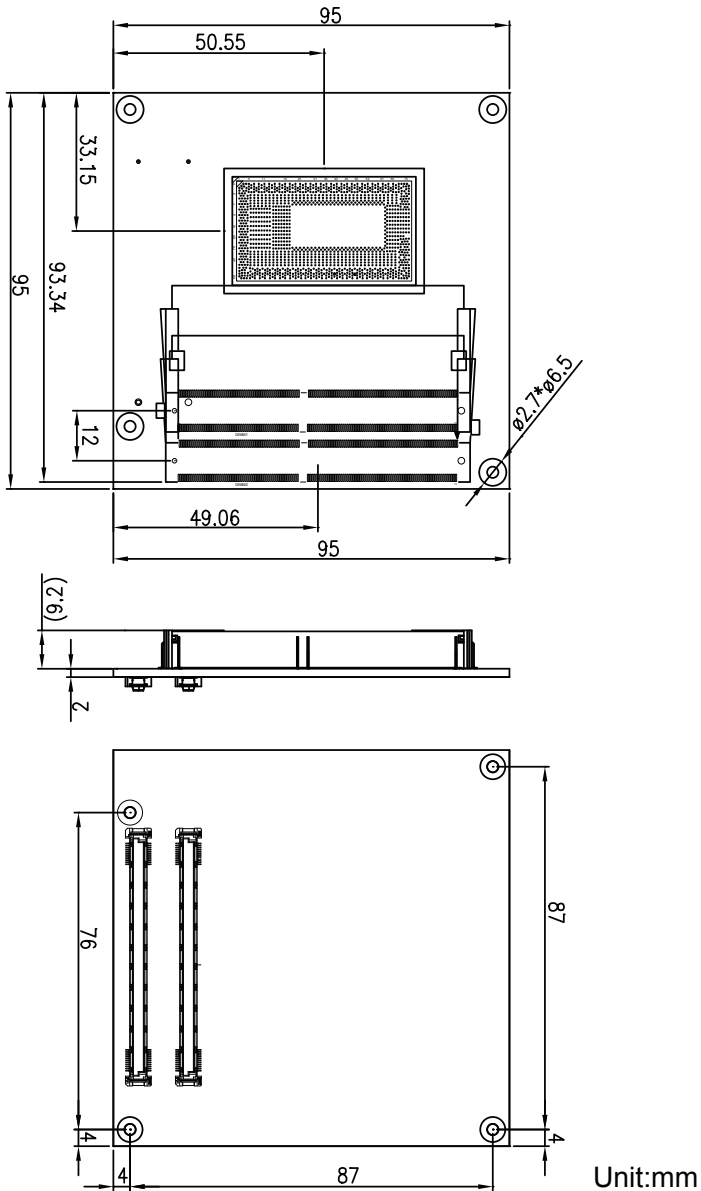

2.3 Block Diagram

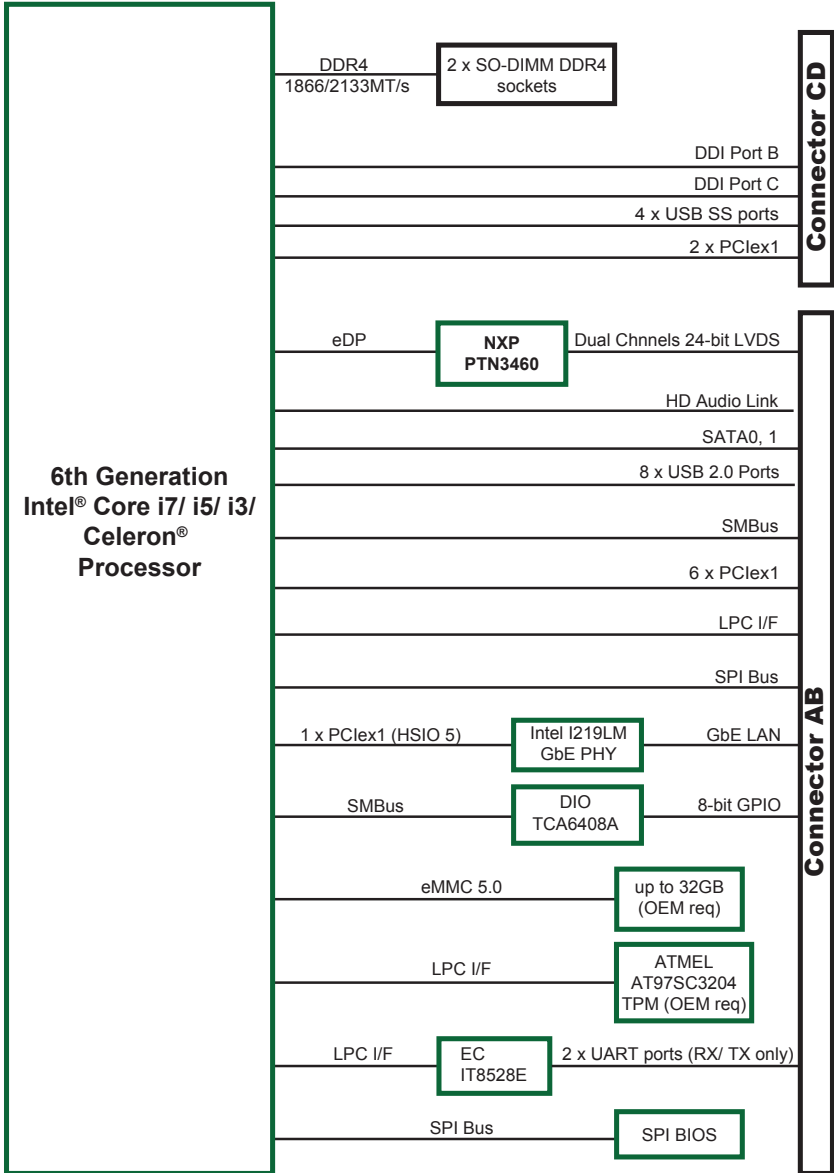

2.4 Connector Pin Definition

Being a most commonly-used Type 6, the EmETXe-i89U0 features two board-to-board connectors on bottom side.

Top Side

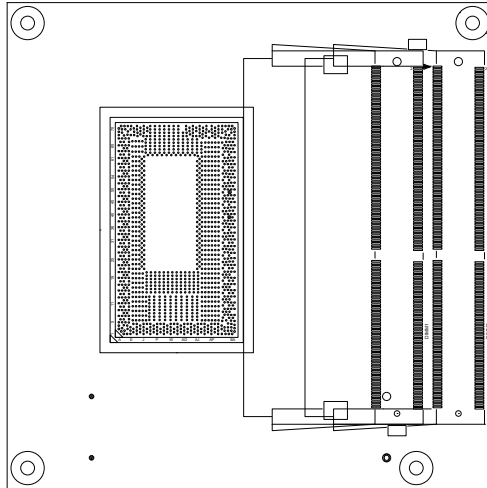

Bottom Side

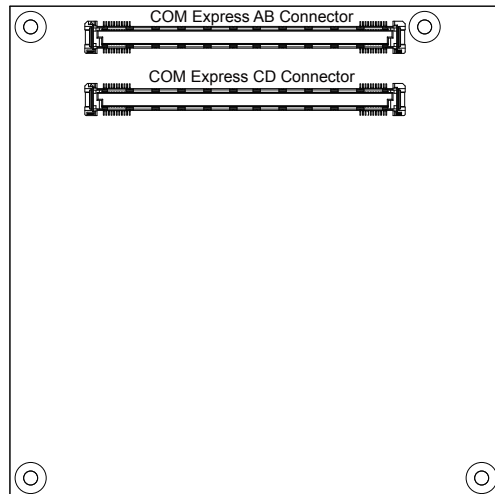

COM Express AB Connector (bottom side)

B1	GND (FIXED)	GND (FIXED)	A1	B56	PCIE_RX4-	PCIE_TX4-	A56
B2	GBE0_ACT#	GBE0_MDI3-	A2	B57	GPO2	GND	A57
B3	LPC_FRAME#	GBE0_MDI3+	A3	B58	PCIE_RX3+	PCIE_TX3+	A58
B4	LPC_AD0	GBE0_LINK100#	A4	B59	PCIE_RX3-	PCIE_TX3-	A59
B5	LPC_AD1	GBE0_LINK1000#	A5	B60	GND	GND	A60
B6	LPC_AD2	GBE0_MDI2-	A6	B61	PCIE_RX2+	PCIE_TX2+	A61
B7	LPC_AD3	GBE0_MDI2+	A7	B62	PCIE_RX2-	PCIE_TX2-	A62
B8	LPC_DRQ0#	N/C	A8	B63	GPO3	GP11	A63
B9	LPC_DRQ1#	GBE0_MDI1-	A9	B64	PCIE_RX1+	PCIE_TX1+	A64
B10	LPC_CLK	GBE0_MDI1+	A10	B65	PCIE_RX1-	PCIE_TX1-	A65
B11	GND (FIXED)	GND (FIXED)	A11	B66	WAKE0#	GND	A66
B12	PWRBTN#	GBE0_MDI0-	A12	B67	WAKE1#	GP12	A67
B13	SMB_CK	GBE0_MDI0+	A13	B68	PCIE_RX0+	PCIE_TX0+	A68
B14	SMB_DAT	GBE_CTRF#	A14	B69	PCIE_RX0-	PCIE_TX0-	A69
B15	SMB_ALERT#	SUS_S3#	A15	B70	GND	GND	A70
B16	SATA1_TX+	SATA0_TX+	A16	B71	LVDS_B0+	LVDS_A0+	A71
B17	SATA1_TX-	SATA0_TX-	A17	B72	LVDS_B0-	LVDS_A0-	A72
B18	SUS_STAT#	SUS_S4#	A18	B73	LVDS_B1+	LVDS_A1+	A73
B19	SATA1_RX+	SATA0_RX+	A19	B74	LVDS_B1-	LVDS_A1-	A74
B20	SATA1_RX-	SATA0_RX-	A20	B75	LVDS_B2+	LVDS_A2+	A75
B21	GND (FIXED)	GND (FIXED)	A21	B76	LVDS_B2-	LVDS_A2-	A76
B22	N/C	N/C	A22	B77	LVDS_B3+	LVDS_VDD_EN	A77
B23	N/C	N/C	A23	B78	LVDS_B3-	LVDS_A3+	A78
B24	PWR_OK	SUS_S5#	A24	B79	LVDS_BKLT_EN	LVDS_A3-	A79
B25	N/C	N/C	A25	B80	GND	GND	A80
B26	N/C	N/C	A26	B81	LVDS_B_CK+	LVDS_A_CK+	A81
B27	WDT	BATLOW#	A27	B82	LVDS_B_CK-	LVDS_A_CK-	A82
B28	N/C	ATA_ACT#	A28	B83	CKLVDS_BKLT_CTRL	LVDS_I2C_CK	A83
B29	AC_SDIN1	AC_SYNC	A29	B84	VCC_5V_SBY	LVDS_I2C_DAT	A84
B30	AC_SDIN0	AC_RST#	A30	B85	VCC_5V_SBY	GP13	A85
B31	GND	GND	A31	B86	VCC_5V_SBY	RSVD	A86
B32	SPKR	AC_BITCLK	A32	B87	VCC_5V_SBY	RSVD	A87
B33	N/C	AC_SDOUT	A33	B88	BIOS_DIS1#	PCIE0_CK_REF+	A88
B34	N/C	BIOS_DISABLE0#	A34	B89	N/C	PCIE0_CK_REF-	A89
B35	THRM#	THRMTRIP#	A35	B90	GND	GND	A90
B36	USB7-	USB6-	A36	B91	N/C	SPL_POWER	A91
B37	USB7+	USB6+	A37	B92	N/C	SPL_MISO	A92
B38	USB_4_5_OC#	USB_6_7_OC#	A38	B93	N/C	GPO0	A93
B39	USB5-	USB4-	A39	B94	N/C	SPL_CLK	A94
B40	USB5+	USB4+	A40	B95	N/C	SPL_MOSI	A95
B41	GND	GND	A41	B96	N/C	TPM_PP	A96
B42	USB3-	USB2-	A42	B97	SPL_CS#	N/C	A97
B43	USB3+	USB2+	A43	B98	N/C	UART_TX0	A98
B44	USB_0_1_OC#	USB_2_3_OC#	A44	B99	N/C	UART_RX0	A99
B45	USB1-	USB0-	A45	B100	GND	GND	A100
B46	USB1+	USB0+	A46	B101	FAN_PWMOUT	UART_TX1	A101
B47	EXCD1_PERST#	VCC_RTC	A47	B102	FAN_TACHIN	UART_RX1	A102
B48	EXCD1_CPPE#	EXCD0_PERST#	A48	B103	SLEEP#	LID#	A103
B49	SYS_RESET#	EXCD0_CPPE#	A49	B104	VCC_12V	VCC_12V	A104
B50	CB_RESET#	LPC_SERIRQ	A50	B105	VCC_12V	VCC_12V	A105
B51	GND	GND	A51	B106	VCC_12V	VCC_12V	A106
B52	PCIE_RX5+	PCIE_TX5+	A52	B107	VCC_12V	VCC_12V	A107
B53	PCIE_RX5-	PCIE_TX5-	A53	B108	VCC_12V	VCC_12V	A108
B54	GPO1	GP10	A54	B109	VCC_12V	VCC_12V	A109
B55	PCIE_RX4+	PCIE_TX4+	A55	B110	GND	GND	A110

COM Express CD Connector (bottom side)

D1	GND(FIXED)	GND (FIXED)	C1	D56	N/C	N/C	C56
D2	GND	GND	C2	D57	TYPE2#	N/C	C57
D3	USB_SSTX0-	USB_SSRX0-	C3	D58	N/C	N/C	C58
D4	USB_SSTX0+	USB_SSRX0+	C4	D59	N/C	N/C	C59
D5	GND	GND	C5	D60	GND (FIXED)	GND (FIXED)	C60
D6	USB_SSTX1-	USB_SSRX1-	C6	D61	N/C	N/C	C61
D7	USB_SSTX1+	USB_SSRX1+	C7	D62	N/C	N/C	C62
D8	GND	GND	C8	D63	N/C	N/C	C63
D9	USB_SSTX2-	USB_SSRX2-	C9	D64	N/C	N/C	C64
D10	USB_SSTX2+	USB_SSRX2+	C10	D65	N/C	N/C	C65
D11	GND (FIXED)	GND (FIXED)	C11	D66	N/C	N/C	C66
D12	USB_SSTX3-	USB_SSRX3-	C12	D67	N/C	N/C	C67
D13	USB_SSTX3+	USB_SSRX3+	C13	D68	N/C	N/C	C68
D14	GND	GND	C14	D69	N/C	N/C	C69
D15	DDI1_CTRLCLK_AUX+	N/C	C15	D70	GND (FIXED)	GND (FIXED)	C70
D16	DDI1_CTRLCLK_AUX-	N/C	C16	D71	N/C	N/C	C71
D17	N/C	RSVD	C17	D72	N/C	N/C	C72
D18	N/C	RSVD	C18	D73	GND	GND	C73
D19	PCIE_TX6+	PCIE_RX6+	C19	D74	N/C	N/C	C74
D20	PCIE_TX6-	PCIE_RX6-	C20	D75	N/C	N/C	C75
D21	GND(FIXED)	GND(FIXED)	C21	D76	GND	GND	C76
D22	PCIE_TX7+	PCIE_RX7+	C22	D77	N/C	N/C	C77
D23	PCIE_TX7-	PCIE_RX7-	C23	D78	N/C	N/C	C78
D24	N/C	DDI1_HPD	C24	D79	N/C	N/C	C79
D25	N/C	N/C	C25	D80	GND (FIXED)	GND (FIXED)	C80
D26	DDI1_PAIR0+	N/C	C26	D81	N/C	N/C	C81
D27	DDI1_PAIR0-	RSVD	C27	D82	N/C	N/C	C82
D28	N/C	RSVD	C28	D83	N/C	N/C	C83
D29	DDI1_PAIR1+	N/C	C29	D84	GND	GND	C84
D30	DDI1_PAIR1-	N/C	C30	D85	N/C	N/C	C85
D31	GND(FIXED)	GND (FIXED)	C31	D86	N/C	N/C	C86
D32	DDI1_PAIR2+	DDI2_CTRLCLK_AUX+	C32	D87	GND	GND	C87
D33	DDI1_PAIR2-	DDI2_CTRLCLK_AUX-	C33	D88	N/C	N/C	C88
D34	DDI1_DDC_AUX_SEL	DDI2_DDC_AUX_SEL	C34	D89	N/C	N/C	C89
D35	N/C	RSVD	C35	D90	GND (FIXED)	GND (FIXED)	C90
D36	DDI1_PAIR3+	N/C	C36	D91	N/C	N/C	C91
D37	DDI1_PAIR3-	N/C	C37	D92	N/C	N/C	C92
D38	N/C	N/C	C38	D93	GND	GND	C93
D39	DDI2_PAIR0+	N/C	C39	D94	N/C	N/C	C94
D40	DDI2_PAIR0-	N/C	C40	D95	N/C	N/C	C95
D41	GND(FIXED)	GND(FIXED)	C41	D96	GND	GND	C96
D42	DDI2_PAIR1+	N/C	C42	D97	N/C	N/C	C97
D43	DDI2_PAIR1-	N/C	C43	D98	N/C	N/C	C98
D44	DDI2_HPD	N/C	C44	D99	N/C	N/C	C99
D45	N/C	RSVD	C45	D100	GND (FIXED)	GND (FIXED)	C100
D46	DDI2_PAIR2+	N/C	C46	D101	N/C	N/C	C101
D47	DDI2_PAIR2-	N/C	C47	D102	N/C	N/C	C102
D48	N/C	RSVD	C48	D103	GND	GND	C103
D49	DDI2_PAIR3+	N/C	C49	D104	VCC_12V	VCC_12V	C104
D50	DDI2_PAIR3-	N/C	C50	D105	VCC_12V	VCC_12V	C105
D51	GND (FIXED)	GND (FIXED)	C51	D106	VCC_12V	VCC_12V	C106
D52	N/C	N/C	C52	D107	VCC_12V	VCC_12V	C107
D53	N/C	N/C	C53	D108	VCC_12V	VCC_12V	C108
D54	PEG_LANE_RV#	N/C	C54	D109	VCC_12V	VCC_12V	C109
D55	N/C	N/C	C55	D110	GND (FIXED)	GND (FIXED)	C110

This page is intentionally left blank.



Chapter 3

Installation & Maintenance

3.1 Installing the CPU Module on Carrier Board

1. Find the COM Express connectors on carrier board PBE-1705, which is available in [Section 1.5.1 Optional Accessories on page 5](#).
2. Embed EmETXe-i89U0 into PBE-1705 via COM Express connectors as below; that is, COM Express AB to AB and CD to CD.

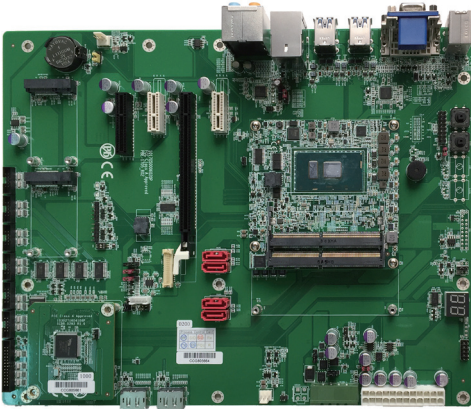
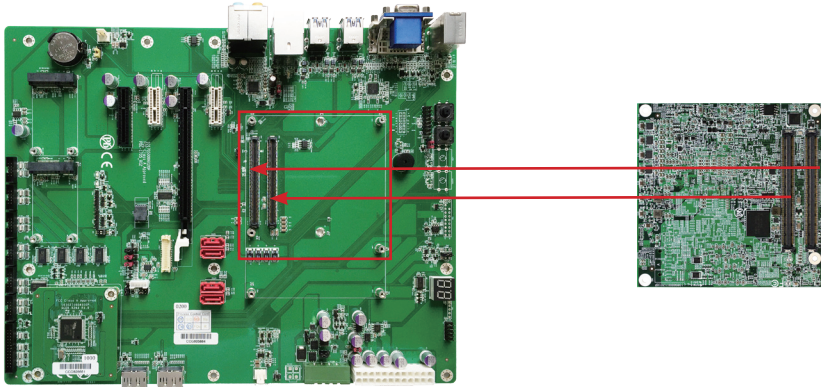

3.2 Installing the Heatsink

1. Locate EmETXe-i89U0 mounted on PBE-1705.
2. Prepare the heatspred included in optional accessories. (See section [1.5.1 Optional Accessories on page 5](#)) Put heatspred on the CPU module and lock it. Make sure thermal grease in contact with CPU and chipset on CPU module. Plug power cable into appropriate connector if there is a fan.

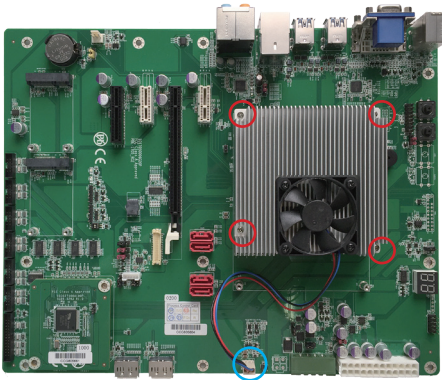
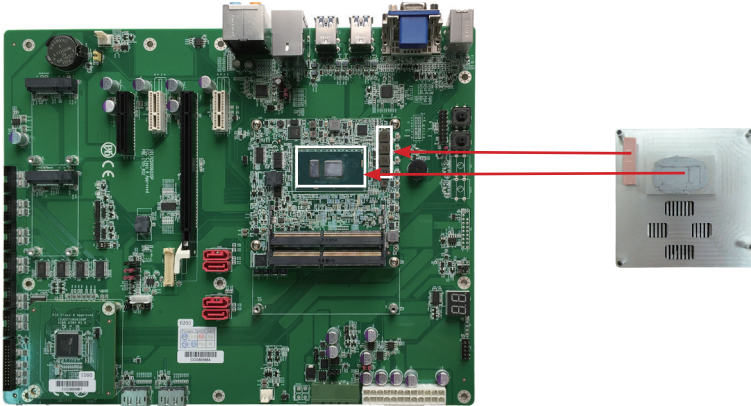

This page is intentionally left blank.

Chapter 4

BIOS

4.1 Main

The AMI BIOS provides a Setup utility program for specifying the system configurations and settings. The BIOS RAM of the system stores the Setup utility and configurations. When you turn on the computer, the AMI BIOS is immediately activated. To enter the BIOS SETUP UTILITY, press “Delete” once the power is turned on.

The **Main Setup** screen lists the following information:

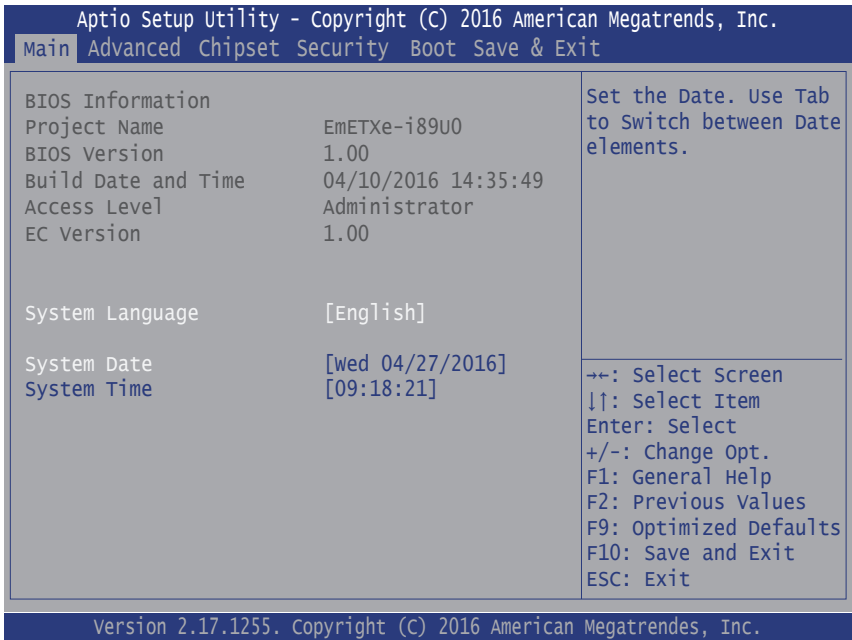

Setting	Description
System Language	Choose the system default language.
System Date	Set the system date. Use Tab to switch between Data elements. Note that the ‘Day’ automatically changes when you set the date. ► The date format is: Day: Sun to Sat Month: 1 to 12 Date: 1 to 31 Year: 1998 to 2099

System Time	<p>Set the system time. Use Tab to switch between Time elements.</p> <p>▶ The time format is: Hour: 00 to 23 Minute: 00 to 59 Second: 00 to 59</p>
-------------	---

Key Commands

BIOS Setup Utility is mainly a key-based navigation interface. Please refer to the following key command instructions for navigation process.

Keystroke	Function
◀ ▶	Move to highlight a particular configuration screen from the top menu bar / Move to highlight items on the screen
▼ ▲	Move to highlight previous/next item
Enter	Select and access a setup item/field
Esc	On the Main Menu – Quit the setup and not save changes into CMOS (a message screen will display and ask you to select “OK” or “Cancel” for exiting and discarding changes. Use “←” and “→” to select and press “Enter” to confirm) On the Sub Menu – Exit current page and return to main menu
Page Up / +	Increase the numeric value on a selected setup item / make change
Page Down / -	Decrease the numeric value on a selected setup item / make change
F1	Activate “General Help” screen
F10	Save the changes that have been made in the setup and exit. (a message screen will display and ask you to select “OK” or “Cancel” for exiting and saving changes. Use “←” and “→” to select and press “Enter” to confirm)

4.2 Advanced

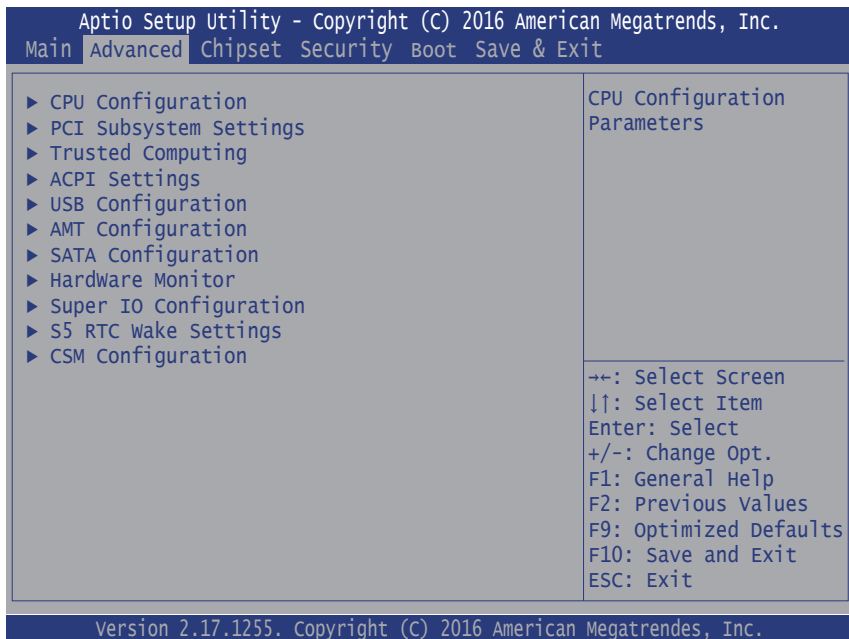

Setting	Description
CPU Configuration	See section 4.2.1 CPU Configuration on page 23
PCI Subsystem Settings	See section 4.2.2 PCI Subsystem Settings on page 25
Trusted Computing	See section 4.2.3 Trusted Computing on page 26
ACPI Settings	See section 4.2.4 ACPI Settings on page 27
USB Configuration	See section 4.2.5 USB Configuration on page 28
AMT Configuration	See section 4.2.6 AMT Configuration on page 30
SATA Configuration	See section 4.2.7 SATA Configuration on page 31
Hardware Monitor	See section 4.2.8 Hardware Monitor on page 32
Super IO Configuration	See section 4.2.9 Super IO Configuration on page 33
S5 RTC Wake Settings	See section 4.2.10 S5 RTC Wake Settings on page 35
CSM Configuration	See section 4.2.11 CSM Configuration on page 36

4.2.1 CPU Configuration

Aptio Setup Utility - Copyright (C) 2016 American Megatrends, Inc.

Advanced

CPU Configuration		Enabled for windows XP and Linux (OS optimized for Hyper-Threading Technology) and Disabled for other OS (OS not optimized for Hyper-Threading Technology). When disabled only one thread per enabled core is enabled.
Intel(R) Core(TM) i7-6600U CPU @ 2.60Ghz		
CPU Signature	406E3	
Microcode Patch	7C	
Max CPU Speed	2600 MHz	
Min CPU Speed	400 MHz	
CPU Speed	3200 MHz	
Processor Cores	2	
L1 Data Cache	32 KB x 2	
L1 Code Cache	32 KB x 2	
L2 Cache	256 KB x 2	
L3 Cache	4 MB	
L4 Cache	Not Present	
Hyper-threading	[Enabled]	
Active Processor Cores	[All]	→: Select Screen
Intel Virtualization Technology	[Enabled]	↓↑: Select Item
Boot performance Mode	[Turbo Performance]	Enter: Select
Intel (R) SpeedStep (tm)	[Enabled]	+/-: Change Opt.
Turbo Mode	[Enabled]	F1: General Help
CPU C states	[Disabled]	F2: Previous Values
		F9: Optimized Defaults
		F10: Save and Exit
		ESC: Exit

Version 2.17.1255. Copyright (C) 2016 American Megatrends, Inc.

Setting	Description
Hyper-threading	Enabled (default) for Windows XP and Linux (OS optimized for Hyper-Threading Technology) and Disabled for other OS (OS not optimized or Hyper-Threading Technology). When disabled only one thread per enabled core is enabled.
Active Processor Cores	Number of cores to enable in each processor package. ▶ Options: All (default) and 1
Intel Virtualization Technology	When enabled, a VMM can utilize the additional hardware capabilities provided by Vanderpool Technology ▶ Options: Enabled (default) or Disabled

Boot performance Mode	<p>Set the performance state that the BIOS will set before the OS handoff.</p> <p>► Options: Max Battery, Max Non-Turbo Performance and Turbo Performance (default).</p>
Intel (R) Speed Step (tm)	Enable (default)/ Disable Intel SpeedStep
Turbo Mode	<p>Only available when Intel Speed Step is Enabled.</p> <p>Enable (default)/Disable Turbo Mode</p>
CPU C States	Enable /Disable (default) CPU C States
Enhanced C-states	<p>Only available when CPU C States is Enabled.</p> <p>Enable (default)/Disable C1E. When enabled, CPU will switch to minium speed when all cores enter C-State.</p>
CState Pre-Wake	<p>Only available when CPU C States is set Enabled.</p> <p>Enable (default) / Disable CState Pre-Wake</p> <p>When disabled, set bit 30 of POWER_CTL MSR (0x1FC) to 1 to disable the Cstate Pre-Wake.</p>
Package C State Limit	<p>Only available when CPU C States is Enabled.</p> <p>Set package C State limit.</p> <p>► Options: C0/C1, C2, C3, C6, C7, C7s, C8, C9, C10, AUTO (default).</p>

4.2.2 PCI Subsystem Settings

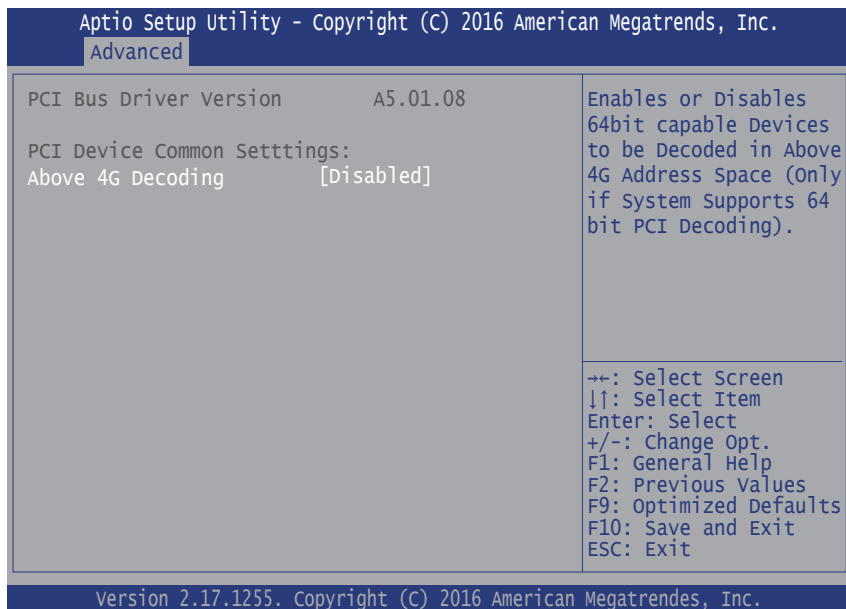

Setting	Description
Above 4G Decoding	Enable/Disable (default) 64bit capable Devices to be Decoded in Above 4G Address Space (Only if System Supports 64 bit PCI Decoding).

4.2.3 Trusted Computing

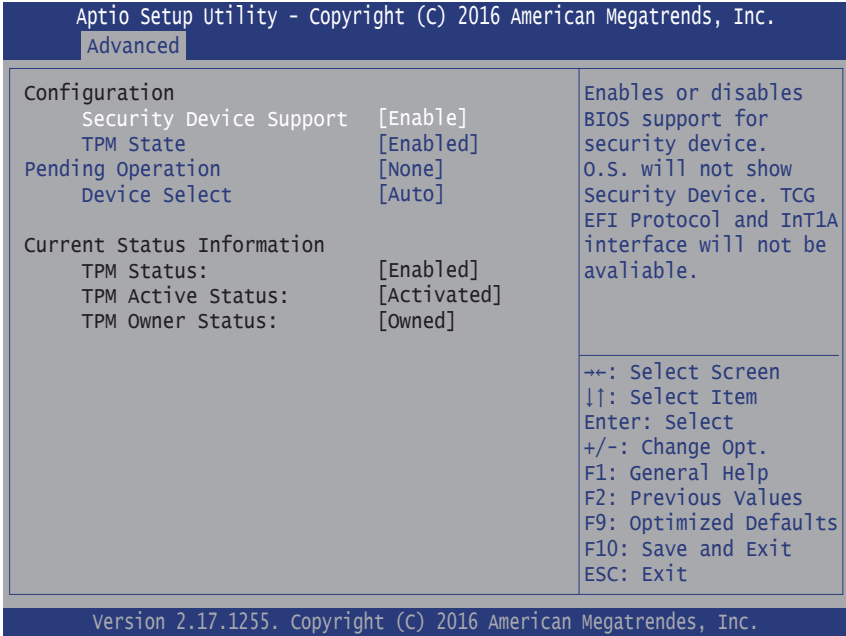

Setting	Description
Security Device Support	Enable (default) or Disable BIOS support for security device.
TPM State	Enable (default) or Disable Security Device. Note that your computer will reboot during restart in order to change state of the device.
Pending operation	Schedule an Operation for the security Device. Your computer will reboot during restart in order to change State of Security Device. ▶ Options: None (default) and TPM Clear
Device Select	Sets the security device. ▶ Options: TPM 1.2 , TPM 2.0 and Auto (default). TP 1.2 will restrict support to TPM 1.2 devices. TPM 2.0 will restrict support to TPM 2.0 devices. Auto will support both with the defaults set to TPM 2.0 devices if not found, TPM 1.2 devices will be enumerated.

4.2.4 ACPI Settings

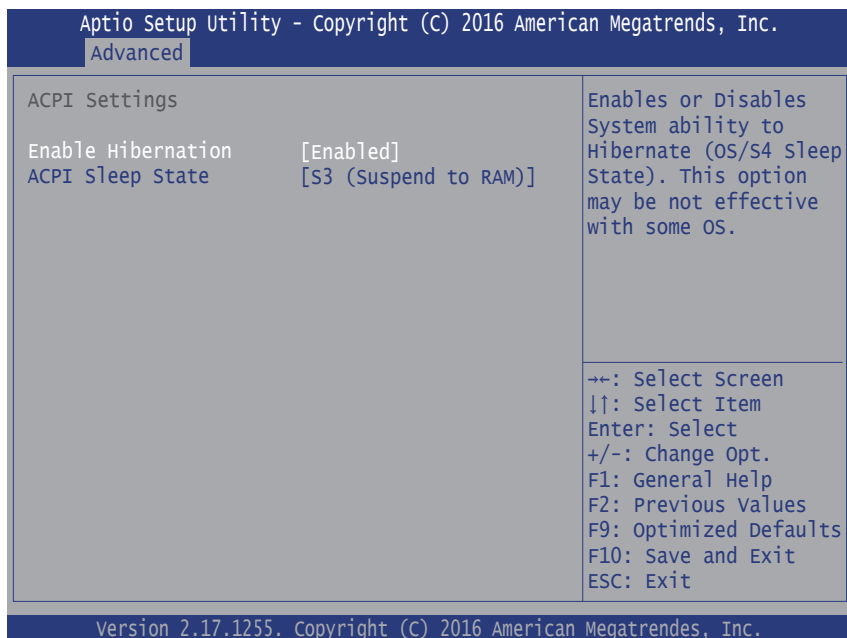

Setting	Description
Enable Hibernation	Enable (default) or Disable System ability to Hibernate (OS/S4 Sleep State). This option may be not effective with some OS.
ACPI Sleep State	Select the highest ACPI sleep state the system will enter when the SUSPEND button is pressed. ► Options: Suspend Disabled and S3 (Suspend to RAM) (default).

4.2.5 USB Configuration

Aptio Setup Utility - Copyright (C) 2016 American Megatrends, Inc.
 Advanced

USB Configuration		Enables Legacy USB support. AUTO option disables legacy support if no USB devices are connected. DISABLE option will keep USB devices available only for EFI applications.
USB Module Version	13	
USB Devices:	1 XHCI	
USB Devices:	1 Keyboard, 1 Hub	
Legacy USB Support	[Enabled]	→←: Select Screen ↓↑: Select Item Enter: Select +/-: Change Opt. F1: General Help F2: Previous Values F9: Optimized Defaults F10: Save and Exit ESC: Exit
XHCI Hand-off	[Disabled]	
USB Mass Storage Driver Support	[Enabled]	
Port 60/64 Emulation	[Disabled]	
USB hardware delays and time-outs:		
USB Transfer time-out	[20 sec]	
Device reset time-out	[20 sec]	
Device power-up delay	[Auto]	

Version 2.17.1255. Copyright (C) 2016 American Megatrends, Inc.

Setting	Description
Legacy USB Support	Sets legacy USB support. ► Options: Enabled (default), Disabled and Auto . AUTO option disables legacy support if no USB devices are connected. Disable option will keep USB devices available only for EFI applications.
XHCI Hand-off	Enable (default) or Disable XHCI Hand-off This is a workaround for OSeS without XHCI hand-off support. The XHCI ownership change should be claimed by XHCI driver.
USB Mass Storage Driver Support	Enable (default) or Disable USB Mass Storage Driver Support.

USB hardware delay and time-out	
USB Transfer time-out	<p>Use this item to set the time-out value for control, bulk, and interrupt transfers.</p> <ul style="list-style-type: none">▶ Options available are: 1 sec, 5 sec, 10 sec, 20 sec (default)
Device reset time-out	<p>Use this item to set USB mass storage device start unit command time-out.</p> <ul style="list-style-type: none">▶ Options available are: 10 sec, 20 sec (default), 30 sec, 40 sec
Device power-up delay	<p>Use this item to set maximum time the device will take before it properly reports itself to the host controller.</p> <ul style="list-style-type: none">▶ Options available are: Auto (Default): 'Auto' uses default value: for a root port it is 100 ms, for a hub port the delay is taken from hub descriptor. Manual: Select Manual you can set value for the following sub-item: 'Device Power-up delay in seconds', the delay range in from 1 to 40 seconds, in one second increments.

4.2.6 AMT Configuration

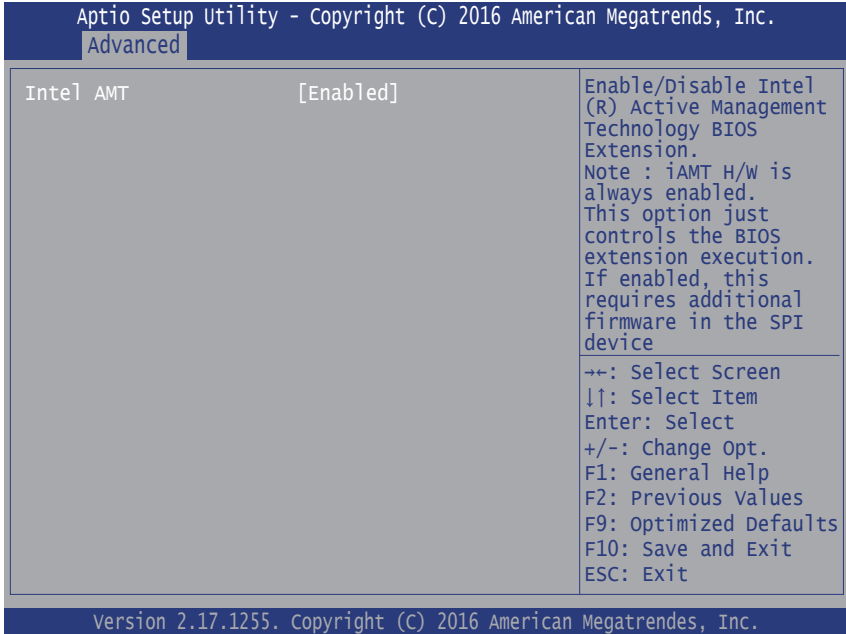

Setting	Description
Intel AMT	Enable (default) / Disable Intel(R)Active Management Technology BIOS Extension. Note : iAMT H/W is always enabled. This option just controls the BIOS extension execution. If enabled, this requires additional firmware in the SPI device.

4.2.7 SATA Configuration

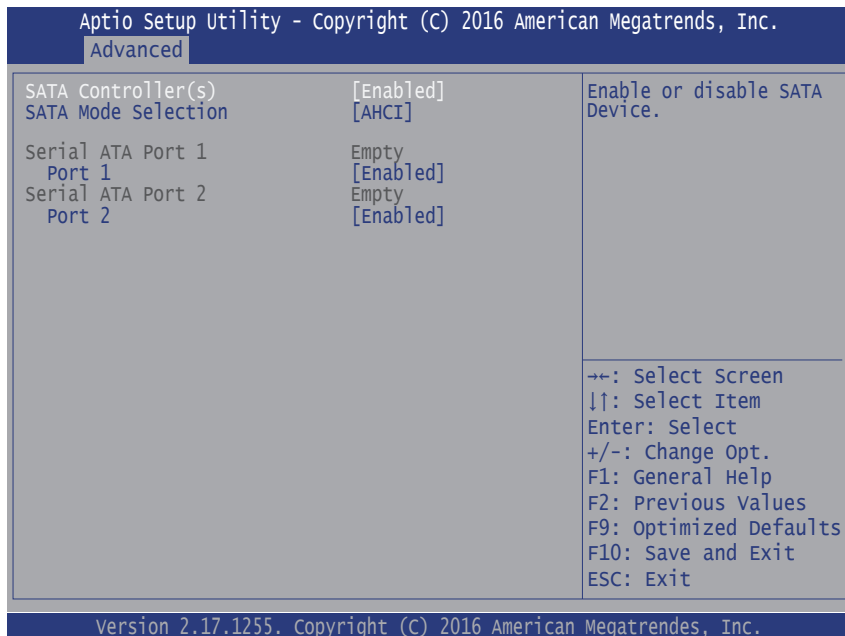

Setting	Description
SATA Controller(s)	Enable (default) or disable SATA Device.
SATA Mode Selection	Determines how SATA controller(s) operate. ► Options: AHCI (default) and RAID
Port 1/2	Enable or disable (default) SATA Port.

4.2.8 Hardware Monitor

Aptio Setup Utility - Copyright (C) 2016 American Megatrends, Inc.

Advanced

PC Health Status	
CPU Temperature	: +37°C
Fan1 Speed	: 4607 RPM
VCORE	: +0.858 V
VCCDU	: +1.189 V
VIN	: +11.942 V

→: Select Screen
↓↑: Select Item
Enter: Select
+/-: Change Opt.
F1: General Help
F2: Previous Values
F9: Optimized Defaults
F10: Save and Exit
ESC: Exit

Version 2.17.1255. Copyright (C) 2016 American Megatrends, Inc.

Access this submenu to monitor the hardware status.

4.2.9 Super IO Configuration

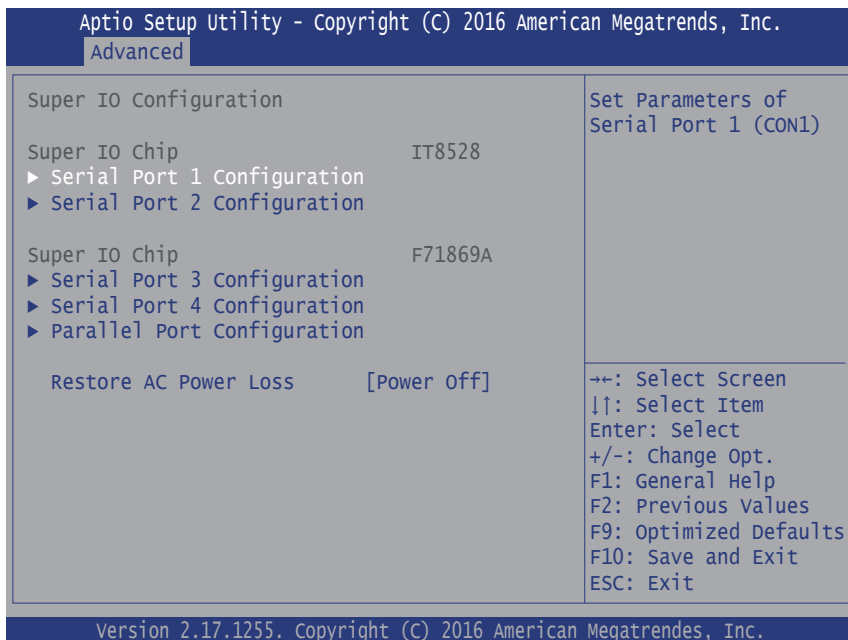

Setting	Description
Serial Port 1/2/3/4 & Parallel Port Configuration	See next page.
Restore AC Power Loss	Specify what state to go to when power is re-applied after a power failure. <ul style="list-style-type: none"> ▶ Options: Last State, Power On and Power Off (default)

Serial Port 1/2/3/4 Configuration

Setting	Description
Serial Port	Enable (default) or Disable Serial Port (COM).
Change Settings	<p>Select an optimal setting for Super IO device.</p> <ul style="list-style-type: none"> ▶ Options for Serial Port 1: Auto; IO=3F8h; IRQ=4 (default) ; IO=3F8h; IRQ=3, 4, 7, 12; IO=2F8h; IRQ=3, 4, 7, 12; ▶ Options for Serial Port 2: Auto IO=2F8h; IRQ=3 (default) IO=3F8h; IRQ=3, 4, 7, 12 IO=2F8h; IRQ=3, 4, 7, 12 ▶ Options for Serial Port 3: Auto IO=3E8h; IRQ=11 (default) IO=3E8h; IRQ=7, 10, 11, 12 IO=2E8h; IRQ=7, 10, 11, 12 IO=2F0h; IRQ=7, 10, 11, 12 IO=2E0h; IRQ=7, 10, 11, 12 ▶ Options for Serial Port 4: Auto IO=2E8h; IRQ=10 (default) IO=3E8h; IRQ=7, 10, 11, 12 IO=2E8h; IRQ=7, 10, 11, 12 IO=2F0h; IRQ=7, 10, 11, 12 IO=2E0h; IRQ=7, 10, 11, 12

Parallel Port Configuration

Setting	Description
Parallel Port	Enable (default) or Disable Parallel Port (LPT/LPTE).
Change Settings	Select an optimal setting for Super IO device. ▶ Options: Auto IO=378h; IRQ=7 (default) IO=378h; IRQ=7, 10, 11, 12 IO=278h; IRQ=7, 10, 11, 12 IO=3BCh; IRQ=7, 10, 11, 12
Device Mode (only for Parallel Port Configuration)	Change the Printer Port mode. ▶ Options: STD Printer Mode (default) SPP Mode EPP-1.9 and SPP Mode EPP-1.7 and SPP Mode ECP Mode ECP and EPP 1.9 Mode ECP and EPP 1.7 Mode.

4.2.10 S5 RTC Wake Settings

Setting	Description
Wake System from S5	Enable or Disable (default) system wake on alarm event. ▶ Options available are: Disabled (default): Fixed Time: System will wake on the hr::min::sec specified. DynamicTime: If selected, you need to set Wake up minute increase from 1 - 5. System will wake on the current time + increase minute(s).

4.2.11 CSM Configuration

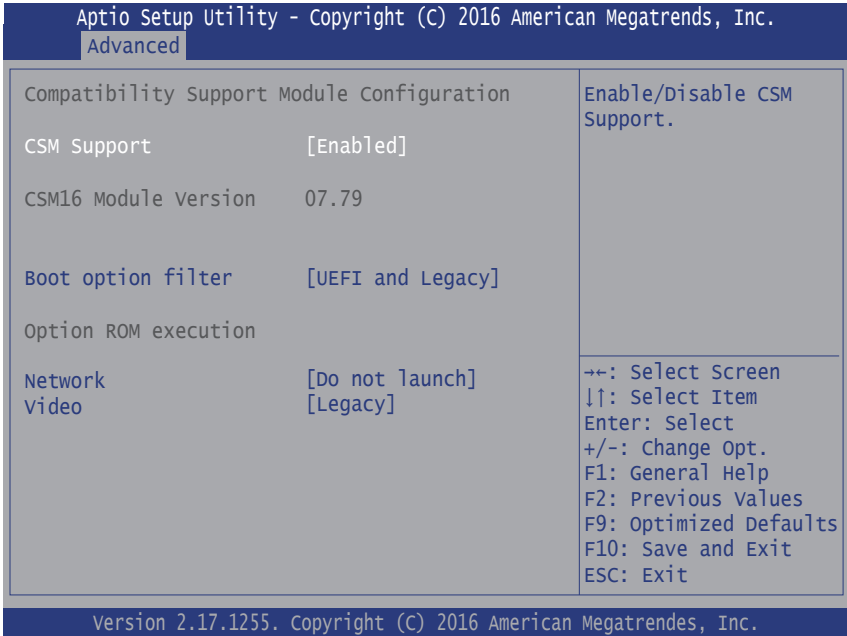

Setting	Description
CSM Support	Enable (default) or Disable CSM Support.
Boot option filter	Control the Legacy/UEFI ROMs priority. ▶ Options: UEFI and Legacy (default), Legacy only , UEFI only
Network	Control the execution of UEFI and Legacy PXE OpROM ▶ Options: Do not launch (default) and Legacy
Video	Control the execution of UEFI and Legacy Storage OpROM ▶ Options: UEFI and Legacy (default)

4.3 Chipset

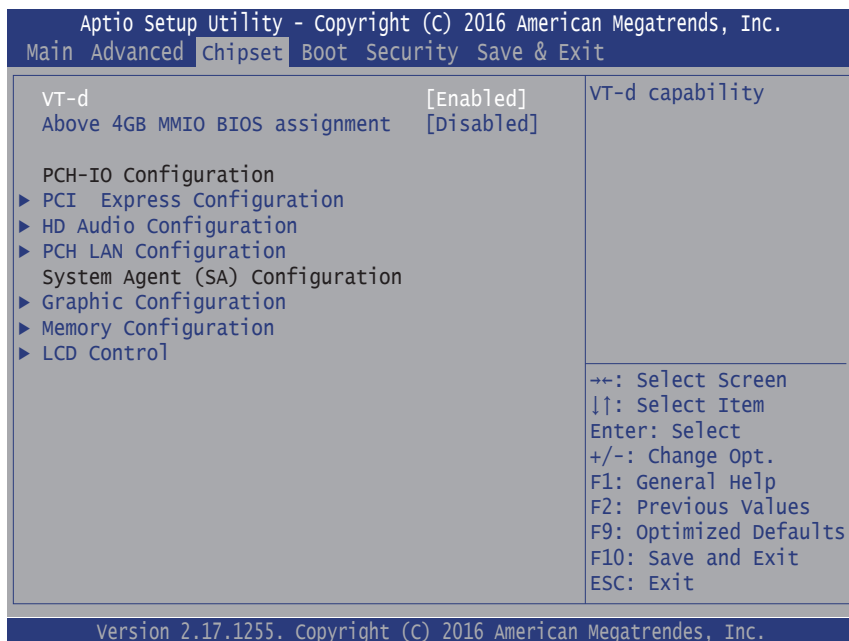

Setting	Description
VT-d	Enable (default) or Disable VT-d function
Above 4GB MMIO BIOS assignment	Enable or Disable (default) Above 4GB MMIO BIOS assignment
PCH-IO Configuration	
PCI Express Configuration	See section 4.3.1 PCI Express Configuration on page 39

<p>HD Audio Configuration</p>	<p>Control Detection of the HD-Audio device.</p> <ul style="list-style-type: none"> ▶ Options available are: <ul style="list-style-type: none"> Disabled: HDA will be unconditionally disabled Enabled: HDA will be unconditionally Enabled Auto (default) = HDA will be enabled if present, disabled otherwise.
<p>PCH LAN Controller</p>	<p>Enables/Disables onboard NIC.</p> <ul style="list-style-type: none"> ▶ Options: Enabled (default) and Disabled <p>If enabled, “Wake on LAN” option will be available to Enable (default) / Disable integrated LAN to wake the system. (the Wake On LAN cannot be disabled if ME is on at Sx state.)</p>
<p>System Agent (SA) Configuration</p>	
<p>Graphic Configuration</p>	<p>See section 4.3.2 Graphics Configuration on page 40</p>
<p>Memory Configuration</p>	<p>See section 4.3.3 Memory Configuration on page 41</p>
<p>LCD Control</p>	<p>See section 4.3.4 LCD Control on page 42</p>

4.3.1 PCI Express Configuration

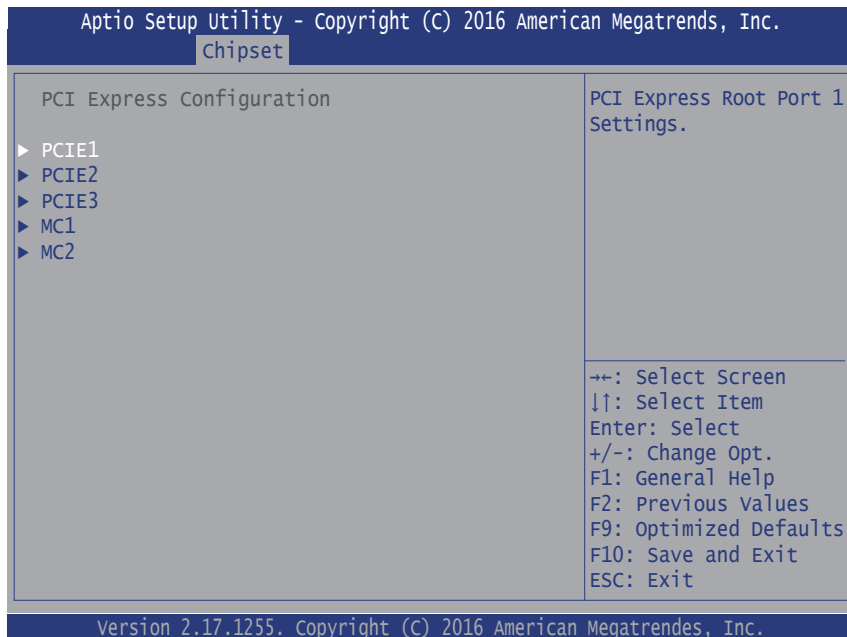

Setting	Description
PCIE3/1/2 & MC1/2	Enable (default) or disable PCIE3/1/2 and MC1/2.
Topology	Identify the SATA Topology if it is Default or ISATA or Flex or DirectConnect or M2. ▶ Options: Unknown , x1 (default for PCIE1/2 & MC1/2), x4 (default for PCIE3), Sata Express and M2 .
ASPM Support	Disable or set the ASPM level. Force L0s will force all links to L0s state. "Auto" will allow BIOS to auto configure."Disable" will disable ASPM. ▶ Options: Disabled (default), L0s , L1 , L0sL1 , Auto .
L1 Substates	Set the PCI Express L1 Substates. ▶ Options: Disabled , L1.1 , L1.2 , and L1.1 & L1.2 (default)
PCIe Speed	Select PCI Express port speed. ▶ Options: Auto (default), Gen1 , Gen2 and Gen3

4.3.2 Graphics Configuration

Setting	Description
Graphics Turbo IMON Current	Sets the graphics turbo IMON current values. ▶ Options available are 14 to 31 (default).
Primary PEG	Set the Primary PEG device. ▶ Options: Auto (default), PEG11 , and PEG12 .
Internal Graphics	Keep IGD enabled based on the setup options. ▶ Options: Auto (default), Disabled and Enabled .
GTT Size	Select the GTT Size. ▶ Options: 4MB , 2MB and 8MB (default).
Aperture Size	Select the Aperture Size. Note that above 4GB MMIO BIOS assignment is automatically enabled when selecting 2048MB aperture. To use this feature, please disable CSM support. ▶ Options: 256MB (default), 128MB , 512MB , 1024MB , 2048MB and 4096MB .
DVMT Pre-Allocated	Select the DVMT 5.0 Pre-allocated (Fixed) Graphic Memory size used by the Internal Graphic Device. ▶ Options: 32M is the default.
DVMT total Gfx Mem	Select the DVMT 5.0 Total Graphic Memory size used by the Internal Graphic Device. ▶ Options: 256MB (default), 128MB and Max .

4.3.3 Memory Configuration

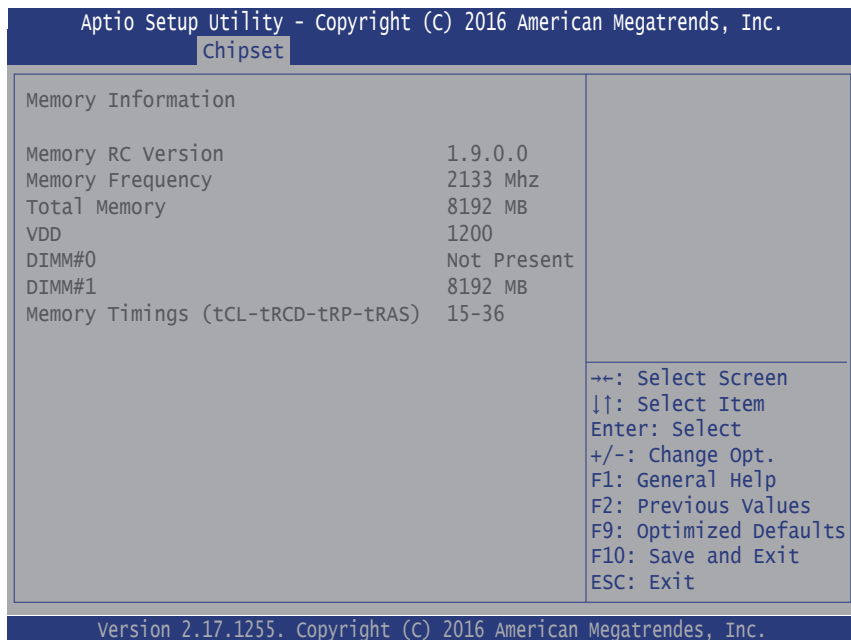

Access this submenu to view the memory configuration.

4.3.4 LCD Control

Setting	Description
Primary IGFX Boot Display	Select the Video Device which will be activated during POST. This has no effect if external graphics present. Secondary boot display selection will appear based on your selection. VGA modes will be supported only on primary display. ▶ Options: VBIOS Default , LCD , DP and DVI
Active LFP	Configuring LFP usage ▶ Options: No LVDS , and eDP Port-A (default)
LCD Panel Type	Select LCD panel used by Internal Graphics Device by selecting the appropriate setup item. ▶ Options: VBIOS Default (default), 640x480 LVDS 800x600 LVDS 1024x768 LVDS 1280x1024 LVDS 1400x1050 LVDS1 1400x1050 LVDS2 1600x1200 LVDS 1280x768 LVDS 1680x1050 LVDS 1920x1200 LVDS 1600x900 LVDS 1280x800 LVDS 1280 x 600 LVDS 2048x1536 LVDS
Backlight Control	Set the Back Light Control. ▶ Options: PWM Inverted and PWM Normal (default)
LVDS Channel Type	Select single or dual channel ▶ Options: Dual and Single (default)
LVDS Panel Color Format	Select LVDS color display mode ▶ Options: 24-BIT and 18-BIT (default)

4.4 Security

The **Security** menu sets up the administrator password.

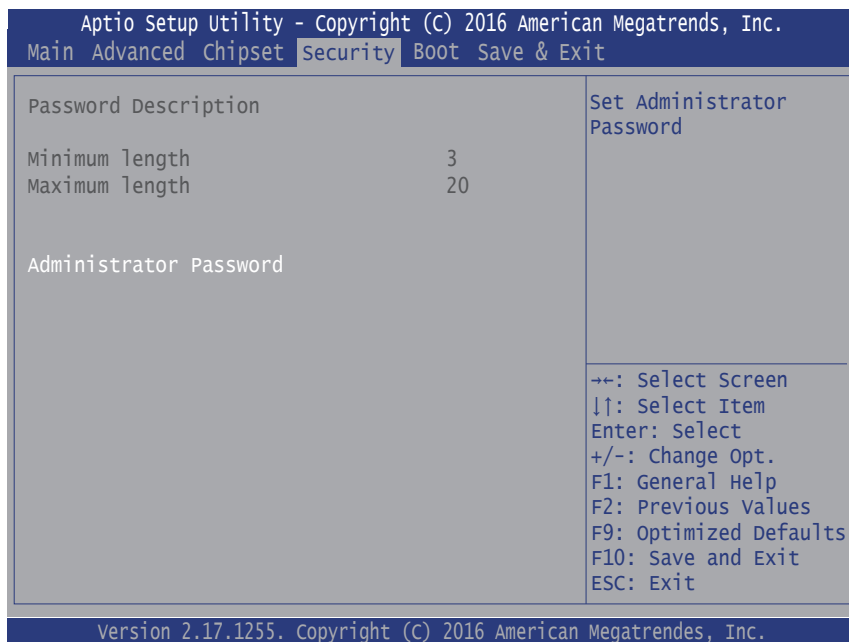

Setting	Description
Administrator Password	<p>To set up an administrator password:</p> <ol style="list-style-type: none"> 1. Select Administrator Password. The screen then pops up an Create New Password dialog. 2. Enter your desired password that is no less than 3 characters and no more than 20 characters. 3. Hit [Enter] key to submit.

4.5 Boot

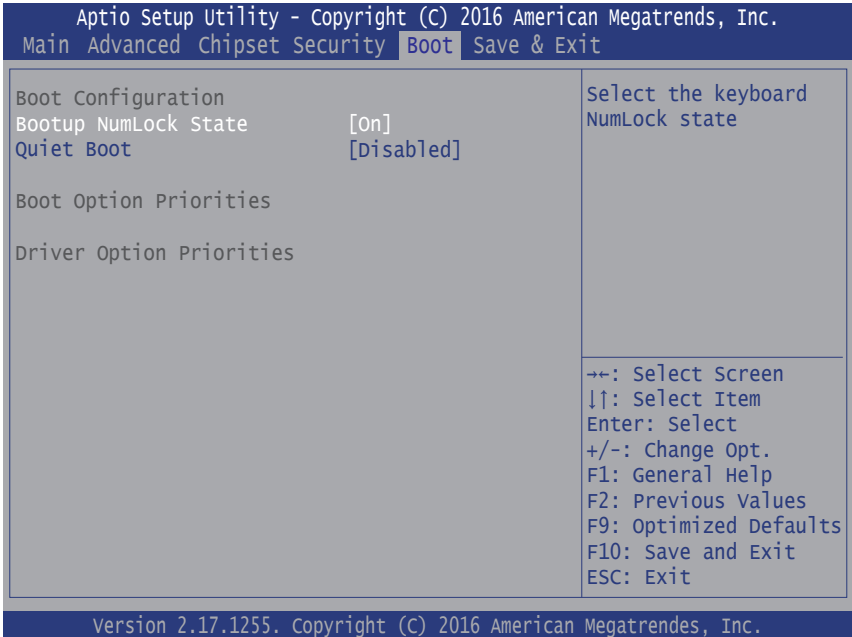

Setting	Description
Boot NumLock State	Select the keyboard NumLock state. ▶ Options: On (default) and Off .
Quiet Boot	Enable (default) or Disable Quiet Boot option.

4.6 Save & Exit

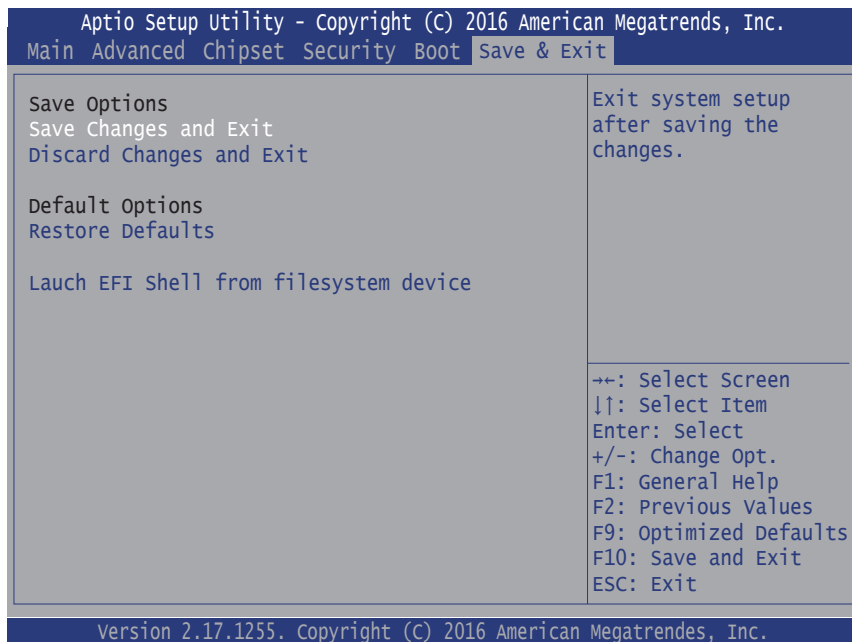

Setting	Description
Save Changes and Exit	Exit system setup after saving the changes. ▶ Enter the item and then a dialog box pops up: Save configuration and exit? (Yes/ No)
Discard Changes and Exit	Exit system setup without saving the changes. ▶ Enter the item and then a dialog box pops up: Quit without saving? (Yes/ No)
Restore Defaults	Restore/Load Default values for all the setup options. ▶ Enter the item and then a dialog box pops up: Load Optimized Defaults? (Yes/ No)
Launch EFI Shell from filesystem device	Attempts to launch EFI shell application (Shell.efi) from one of the available filesystem devices.



Appendix

Appendix A: I/O Port Address Map

Each peripheral device in the system is assigned a set of I/O port addresses which also becomes the identity of the device. The following table lists the I/O port addresses used.

Address	Device Description
03F8-03FF	Communications Port (COM1)
02F8-02FF	Communications Port (COM2)
03E8-03EF	Communications Port (COM3)
02E8-02EF	Communications Port (COM4)
002E-002F	Super IO Access Port
004E-004F	Motherboard resources
0378-037F	Printer Port (LPT1)

Appendix B: Interrupt Request Lines (IRQ)

Peripheral devices use interrupt request lines to notify CPU for the service required. The following table shows the IRQ used by the devices on board.

Level	Function
IRQ0	System timer
IRQ1	PS/2 Keyboard
IRQ3	Communications Port (COM2)
IRQ4	Communications Port (COM1)
IRQ5	SM Bus Controller
IRQ8	RTC Alarm
IRQ10	Communications Port (COM4)
IRQ11	Communications Port (COM3)
IRQ12	PS/2 Mouse
IRQ16~IRQ23	PCIe Devices

Appendix D: Watchdog Timer (WDT) Setting

WDT is widely used for industry application to monitor the activity of CPU. Application software depends on its requirement to trigger WDT with adequate timer setting. Before WDT time out, the functional normal system will reload the WDT. The WDT never time out for a normal system. The WDT will not be reloaded by an abnormal system, then WDT will time out and reset the system automatically to avoid abnormal operation.

This board supports 255 levels watchdog timer by software programming I/O ports. Below are the source codes written in C, please take them as WDT application example.

```
#include "math.h"
#include "stdio.h"
#include "dos.h"

#define DELAY_TIME 10

#define _SMBBA 0xF040 /* SMBus Base Address */
#define _SMBSA 0x6E /* SMBus Slave Address , 75111R's Add = 6Eh or 9Ch */

unsigned char DIO_Set(unsigned char oMode, unsigned char oData);
unsigned char SMB_Byte_READ(int SMPORT, int DeviceID, int iREG_INDEX);
void SMB_Byte_WRITE(int SMPORT, int DeviceID, int oREG_INDEX, int oREG_DATA);

void main()
{
    WDT_Start(10);

    while(1)
    {
        iCount = WDT_Count();
        printf("\r Counts : %d ",iCount);

        delay(1000);
    }
}

void WDT_Start(int iCount)
{
    int iData;

    /* Configuration and function select Register - Enable WDTOUT2# output */
    iData = SMB_Byte_READ(SMB_PORT_AD,SMB_DEVICE_ADD,0x03);
    iData = iData | 0x03;
    SMB_Byte_WRITE(SMB_PORT_AD,SMB_DEVICE_ADD,0x03,iData);
    delay(DELAY_TIME);

    /* Watchdog Timer Range Register */
    SMB_Byte_WRITE(SMB_PORT_AD,SMB_DEVICE_ADD,0x37,iCount);
}
```

Appendix

```
delay(DELAY_TIME);

/* Watchdog Timer Control Register */
SMB_Byte_WRITE(SMB_PORT_AD, SMB_DEVICE_ADD, 0x36, 0x72);
}

int WDT_Count(void)
{
    int iData;

    /* Watchdog Timer Range Register */
    iData = SMB_Byte_READ(SMB_PORT_AD, SMB_DEVICE_ADD, 0x37);

    return iData;
}

void WDT_Clear(int iCount)
{
    /* Watchdog Timer Range Register */
    SMB_Byte_WRITE(SMB_PORT_AD, SMB_DEVICE_ADD, 0x37, iCount);
}

void WDT_Stop(void)
{
    /* Watchdog Timer Control Register */
    SMB_Byte_WRITE(SMB_PORT_AD, SMB_DEVICE_ADD, 0x36, 0x52);
}
```