EmETXe-i91U0

**COM Express® Compact
Type 6 CPU Module**

User's Manual

Version 1.1

Revision History

Version	Date	Description
1.0	2020.05	Initial release
1.1	2022.10	1. Updated Specification in P.3 2. Updated Ordering Information in P.4 3. Revised Block Diagram in P.10

Preface	iii
Copyright Notice.....	iii
Declaration of Conformity	iii
CE.....	iii
FCC Class B	iii
RoHS.....	iv
SVHC / REACH.....	iv
Warning	v
Replacing the Lithium Battery.....	v
Technical Support	v
Warranty	vi
Chapter 1 - Introduction	1
1.1 The Product.....	2
1.2 About This Manual.....	2
1.3 Specifications	3
1.4 Inside the Package	4
1.5 Ordering Information.....	4
1.5.1 Optional Accessories.....	5
Chapter 2 - Board Overview	7
2.1 What Is “COM Express®”?	8
2.2 Board Dimensions.....	9
2.3 Block Diagram	10
2.4 Connector Pin Definition	11
Chapter 3 - Installation & Maintenance	15
3.1 Installing the CPU Module to Carrier Board.....	16
Chapter 4 - BIOS	19
4.1 Main	20
4.2 Advanced.....	22
4.2.1 CPU Configuration	24
4.2.2 Power & Performance	25
4.2.3 PCH-FW Configuration.....	26
4.2.4 Trusted Computing.....	27

4.2.5	ACPI Settings	28
4.2.6	FAN2 Smart Settings	29
4.2.7	Hardware Monitor	30
4.2.8	Super IO Configuration	31
4.2.9	S5 RTC Configuration	34
4.2.10	Serial Port Console Redirection.....	35
4.2.11	PCI Subsystem Settings	37
4.2.12	USB Configuration	38
4.2.13	CSM Configuration	40
4.2.14	NVMe Configuration	41
4.2.15	SDIO Configuration	42
4.2.16	Newtork Stack Configuration	43
4.3	Chipset	44
4.3.1	System Agent (SA) Configuration.....	45
4.3.2	PCH-IO Configuration	47
4.4	Security	50
4.5	Boot	51
4.6	Save & Exit.....	52
Appendix		53
Appendix A: I/O Port Address Map		54
Appendix B: BIOS Memory Mapping		55
Appendix C: Interrupt Request Lines (IRQ)		57
Appendix D: Watchdog Timer (WDT) Setting.....		58
Appendix E: DIO Sample Code		60

Copyright Notice

All Rights Reserved.

The information in this document is subject to change without prior notice in order to improve the reliability, design and function. It does not represent a commitment on the part of the manufacturer.

Under no circumstances will the manufacturer be liable for any direct, indirect, special, incidental, or consequential damages arising from the use or inability to use the product or documentation, even if advised of the possibility of such damages.

This document contains proprietary information protected by copyright. All rights are reserved. No part of this manual may be reproduced by any mechanical, electronic, or other means in any form without prior written permission of the manufacturer.

Declaration of Conformity

CE

The device is compliant to CE regulation of the European Union (EU) directives. A Certificate of Compliance is available by contacting Technical Support.

This product has passed the CE test for environmental specifications when shielded cables are used for external wiring. We recommend the use of shielded cables. This kind of cable is available from ARBOR. Please contact your local supplier for ordering information.

This product has passed the CE test for environmental specifications. Test conditions for passing included the equipment being operated within an industrial enclosure. In order to protect the product from being damaged by ESD (Electrostatic Discharge) and EMI leakage, we strongly recommend the use of CE-compliant industrial enclosure products.

Warning

This is a class A product. In a domestic environment this product may cause radio interference in which case the user may be required to take adequate measures.

FCC Class B

This device complies with Part 15 of the FCC Rules. Operation is subject to the following two conditions:

- (1) This device may not cause harmful interference, and
- (2) This device must accept any interference received, including interference that may cause undesired operation.

NOTE:

This equipment has been tested and found to comply with the limits for a Class A digital device, pursuant to Part 15 of the FCC Rules. These limits are designed to provide reasonable protection against harmful interference when the equipment is operated in a commercial environment. This equipment generates, uses, and can radiate radio frequency energy and, if not installed and used in accordance with the instruction manual, may cause harmful interference to radio communications. Operation of this equipment in a residential area is likely to cause harmful interference in which case the user will be required to correct the interference at his own expense.

RoHS

ARBOR Technology Corp. certifies that all components in its products are in compliance and conform to the European Union's Restriction of Use of Hazardous Substances in Electrical and Electronic Equipment (RoHS) Directive 2002/95/EC.

The above mentioned directive was published on 2/13/2003. The main purpose of the directive is to prohibit the use of lead, mercury, cadmium, hexavalent chromium, polybrominated biphenyls (PBB), and polybrominated diphenyl ethers (PBDE) in electrical and electronic products. Member states of the EU are to enforce by 7/1/2006.

ARBOR Technology Corp. hereby states that the listed products do not contain unintentional additions of lead, mercury, hex chrome, PBB or PBDB that exceed a maximum concentration value of 0.1% by weight or for cadmium exceed 0.01% by weight, per homogenous material. Homogenous material is defined as a substance or mixture of substances with uniform composition (such as solders, resins, plating, etc.). Lead-free solder is used for all terminations (Sn(96-96.5%), Ag(3.0-3.5%) and Cu(0.5%)).

SVHC / REACH

To minimize the environmental impact and take more responsibility to the earth we live, Arbor hereby confirms all products comply with the restriction of SVHC (Substances of Very High Concern) in (EC) 1907/2006 (REACH --Registration, Evaluation, Authorization, and Restriction of Chemicals) regulated by the European Union.

All substances listed in SVHC < 0.1 % by weight (1000 ppm)

Warning

Single Board Computers and their components contain very delicate Integrated Circuits (IC). To protect the Single Board Computer and its components against damage from static electricity, you should always follow the following precautions when handling it :

1. Disconnect your Single Board Computer from the power source when you want to work on the inside.
2. Hold the board by the edges and try not to touch the IC chips, leads or circuitry.
3. Use a grounded wrist strap when handling computer components.
4. Place components on a grounded antistatic pad or on the bag that comes with the Single Board Computer, whenever components are separated from the system.

Replacing the Lithium Battery

Incorrect replacement of the lithium battery may lead to a risk of explosion.

The lithium battery must be replaced with an identical battery or a battery type recommended by the manufacturer.

Do not throw lithium batteries into the trash-can. It must be disposed of in accordance with local regulations concerning special waste.

Technical Support

If you have any technical difficulties, please consult the user's manual first at:

<http://www.arbor-technology.com>

Please do not hesitate to call or e-mail our customer service when you still cannot find out the answer.

<http://www.arbor-technology.com>

E-mail:info@arbor.com.tw

Warranty

This product is warranted to be in good working order for a period of two years from the date of purchase. Should this product fail to be in good working order at any time during this period, we will, at our option, replace or repair it at no additional charge except as set forth in the following terms. This warranty does not apply to products damaged by misuse, modifications, accident or disaster.

Vendor assumes no liability for any damages, lost profits, lost savings or any other incidental or consequential damage resulting from the use, misuse of, or inability to use this product. Vendor will not be liable for any claim made by any other related party.

Vendors disclaim all other warranties, either expressed or implied, including but not limited to implied warranties of merchantability and fitness for a particular purpose, with respect to the hardware, the accompanying product's manual(s) and written materials, and any accompanying hardware. This limited warranty gives you specific legal rights.

Return authorization must be obtained from the vendor before returned merchandise will be accepted. Authorization can be obtained by calling or faxing the vendor and requesting a Return Merchandise Authorization (RMA) number. Returned goods should always be accompanied by a clear problem description.



Chapter 1

Introduction

1.1 The Product

The EmETXe-i91U0 is a space-conscious CPU board of 95 mm x 95 mm to take up only small footprint in your system. By the architecture of Type 6, the board has two high-performance connectors to promise stable data passing rate. The soldered onboard 6th Generation Intel® Core™ processor, along with integrated Intel® Graphics chipset, bring LVDS, and DDI solution for most monitors or LCD video panels.

For system configuration, the board is supported by AMI UEFI BIOS. EmETXe-i91U0 is an ideal choice for some demanding industrial control and data communications by its significant processing performance, low power consumption and these features:

- Soldered onboard 8th Generation Intel® Core™ i7-8665UE/ i5-8365UE/ i3-8145UE/ Celeron 4305UE processor
- Intel® I219LM PCIe GbE PHY
- Dual Channels 24-bit LVDS and 2 x DDI ports or 1 x DDI + 1 x Analog RGB
- Support 3 independent displays
- 8.5V~20V Wide Range Voltage Input
- Wide Range Operating Temp.: -40 ~ 85°C

1.2 About This Manual

This user's manual provides general information and installation instructions about the product. This user's manual is intended for experienced users and integrators with hardware knowledge of personal computers. If you are not sure about any description in this booklet. Please consult your vendor before further handling.

1.3 Specifications

System	
CPU	Soldered onboard 8th Generation Intel® Core™ - i7-8665UE 1.7GHz (Base)/ 4.4GHz (Turbo) - i5-8365UE 1.6GHz (Base)/ 4.1GHz (Turbo) - i3-8145UE 2.2GHz (Base)/ 3.9GHz (Turbo) - Celeron 4305UE 2.2GHz processor
Memory	2 x DDR4 SO-DIMM sockets
BIOS	AMI UEFI BIOS
Watchdog Timer	1~255 levels reset
I/O	
USB Port	12 x USB ports: - 8 x USB 2.0 ports - 4 x USB 3.1 ports
Serial Port	2 x UART ports (RX/TX only)
Expansion Bus	8 x PCIe1 lanes, I2C Interface
Digital I/O	8-bit Digital Input/Output
Storage	2 x Serial ATA ports Soldered onboard eMMC 5.0 up to 32GB (OEM Request)
Ethernet Chipset	1 x Intel® i219LM PCIe GbE PHY
Audio	HD audio link
TPM	TPM 2.0
Display	
Graphic Chipset	Intergrated Intel® HD Graphics 620
Graphic Interface	LCD: Dual Channels 24-bit LVDS 2 x DDI ports or 1 x DDI port, 1 x Analog RGB port
Mechanical & Environmental	
Power Requirement	8.5V~20V +/- 5% wide range voltage input, +5VSB
Power Consumption	2.3A@12V (i7-8665UE typical, CPU module only)
Operating Temp.	-40 ~ 85°C (-40 ~ 185°F)
Operating Humidity	10 ~ 95% @ 85°C (non-condensing)
Dimensions (L x W)	95 x 95 mm (3.7" x 3.7")

1.4 Inside the Package

Before you begin installing your single board, please make sure that the following materials have been shipped:



1 x EmETXe-i91U0 COM Express CPU Module



1 x Quick Installation Guide

If any of the above items is damaged or missing, contact your vendor immediately.

1.5 Ordering Information

EmETXe-i91U0-WT-8665UE	8th Generation Intel® Core™ i7-8665UE WT COM Express® Compact Type 6 CPU module, w/ DDI
EmETXe-i91U0-WT-8365UE	8th Generation Intel® Core™ i5-8365UE WT COM Express® Compact Type 6 CPU module, w/ DDI
EmETXe-i91U0-WT-8145UE	8th Generation Intel® Core™ i3-8145UE WT COM Express® Compact Type 6 CPU module-, w/ DDI
EmETXe-i91U0-WT-4305UE	8th Generation Intel® Core™ Celeron 4305UE WT COM Express® Compact Type 6 CPU module, w/ DDI
EmETXe-i91U0-WT-8665UE-RGB	8th Generation Intel® Core™ i7-8665UE WT COM Express® Compact Type 6 CPU module, w/ DDI+RGB
EmETXe-i91U0-WT-8365UE-RGB	8th Generation Intel® Core™ i5-8365UE WT COM Express® Compact Type 6 CPU module, w/ DDI+RGB
EmETXe-i91U0-WT-8145UE-RGB	8th Generation Intel® Core™ i3-8145UE WT COM Express® Compact Type 6 CPU module-, w/ DDI+RGB
EmETXe-i91U0-WT-4305UE-RGB	8th Generation Intel® Core™ Celeron 4305UE WT COM Express® Compact Type 6 CPU module, w/ DDI+RGB

1.5.1 Optional Accessories

HS-91U0-F2-T	Heat spreader, threaded standoffs (bore hole) (95x95x11mm)
HS-91U0-F2-NT	Heat spreader, non-threaded standoffs (bore hole) (95x95x11mm)
HS-91U0-C1	Heat sink with Fan (95x95x37.6mm)
PBE-1705-F1	COM Express® Type 6 evaluation carrier board with SIO F71869ED module in ATX form factor
CBK-03-1705-00	Cable kit 1 x SATA cable 2 x Serial port cables

Driver (7.4A) Installation

To install the drivers, please visit our website at <http://www.arbor-technology.com> and download the driver pack from the product page.

Driver	Path
Audio	\EmETXe-i91U0\Audio\Win10_Win8.1_Win8_Win7_WHQLx64
Chipset	\EmETXe-i91U0\Chipset
LAN	\EmETXe-i91U0\Ethernet
Graphic	\EmETXe-i91U0\Graphic\igfx_win10_100.7212
ME	\EmETXe-i91U0\ME



Chapter 2

Board Overview

2.1 What Is “COM Express®”?

With more and more demands on small and embedded industrial boards, a multi-functional COM (Computer-on-Module) surfaces as a great solution.

COM Express® supports seven pin-out types applying to Basic and Extended form factors:

Module Type 1 and 10 support single connector with two rows (220 pins).

Module Type 2, 3, 4, 5 and 6 support two connectors with four rows (440 pins).

EmETXe-i91U0 is a Type-6 module.

Difference between Standard Type 6 and EmETXe-i91U0 is listed as below:

Module Type	Standard Type 6	EmETXe-i91U0
Connectors	2	2
Connector Rows	A, B, C, D	A, B, C, D
PCIe Lanes (Max)	24	8
LAN (Max)	1	1
Serial Ports (Max)	2	2
Digital Display I/F (Max)	3	2
USB 3.0 Ports (Max)	4	4

Row AB provides pins for PCI Express, SATA, LVDS, LCD channel, LPC bus, system and power management, VGA, LAN, and power and ground interfaces.

Row CD provides SDVO and legacy PCI signals next to additional PCI Express, LAN and power and ground signals. The COM are targeted at following applications:

- Retail & Advertising
- Medical
- Test & Measurement
- Gaming & Entertainment
- Industrial & Automation
- Military & Government
- Security

2.2 Board Dimensions

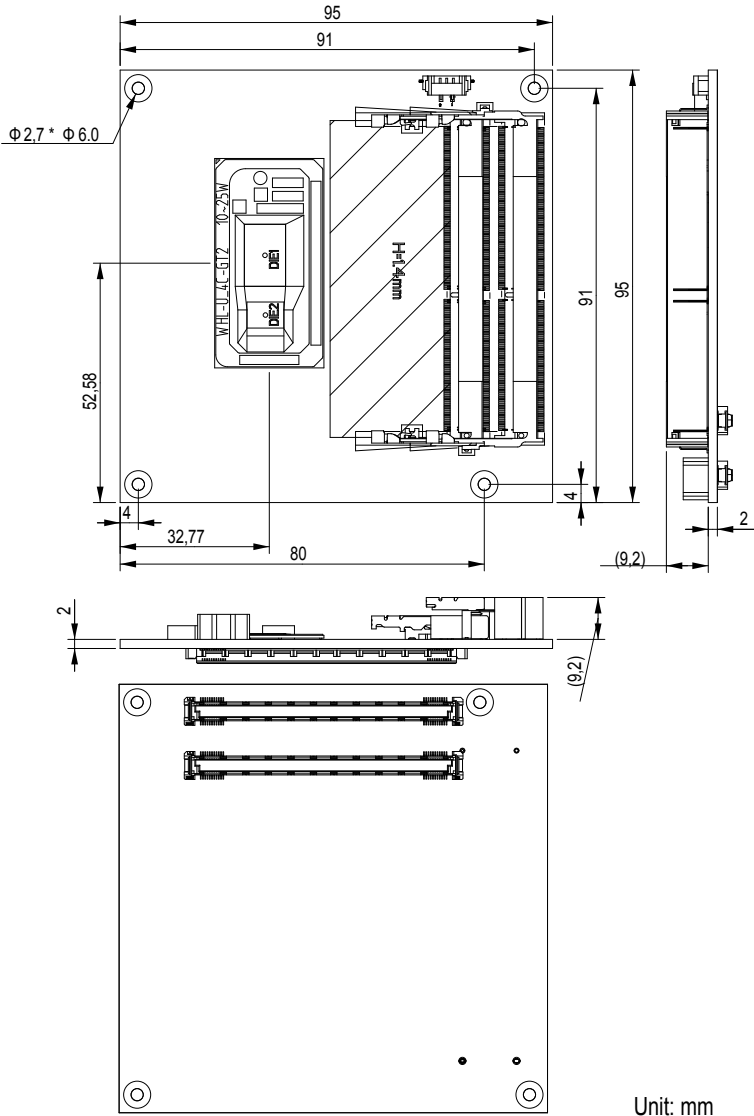

2.3 Block Diagram

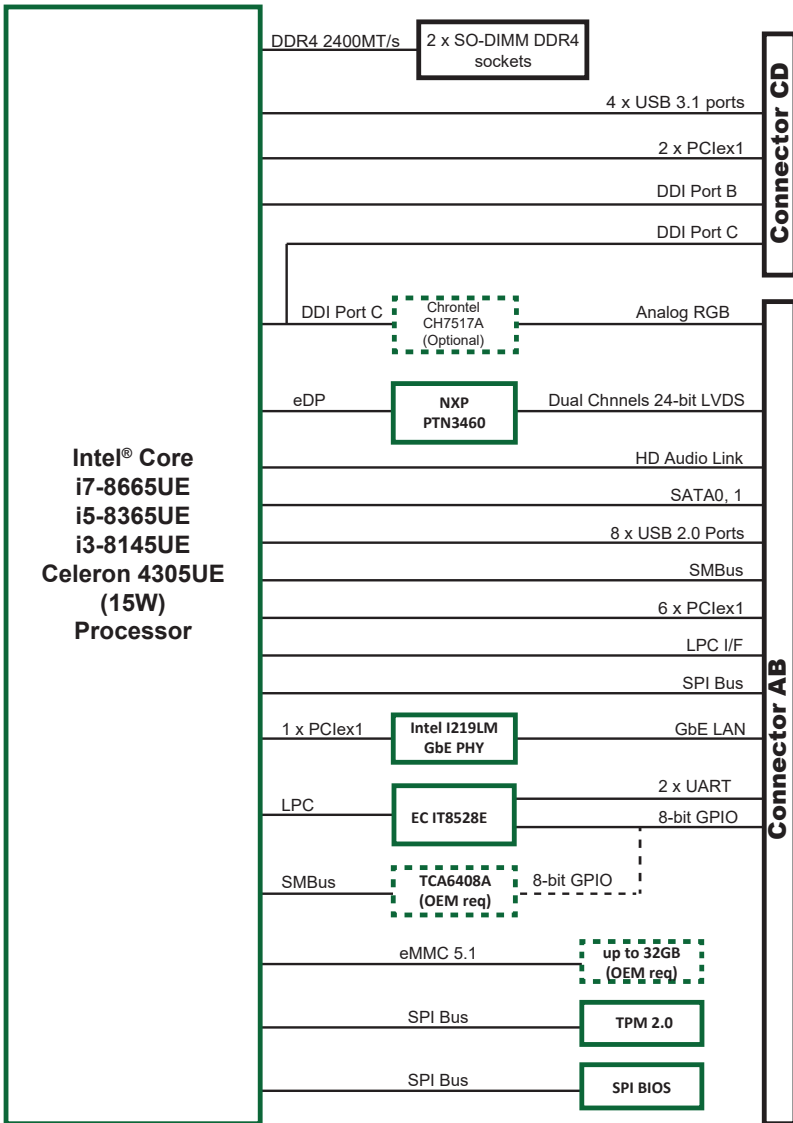

2.4 Connector Pin Definition

Being a most commonly-used Type 6, the EmETXe-i91U0 features two board-to-board connectors on bottom side.

Top Side

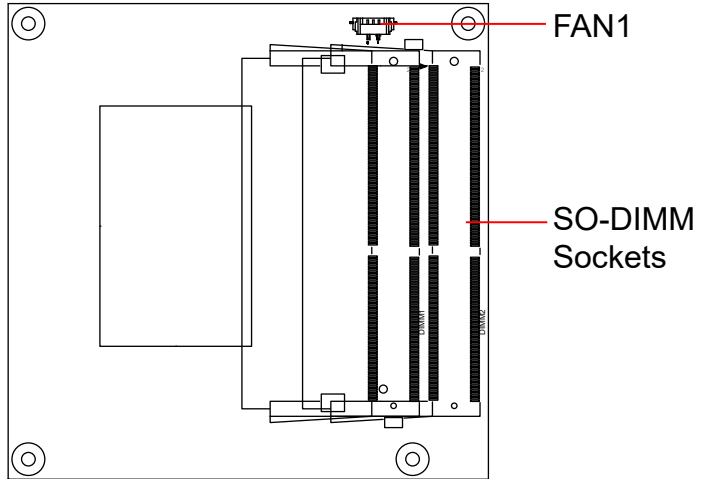

Bottom Side

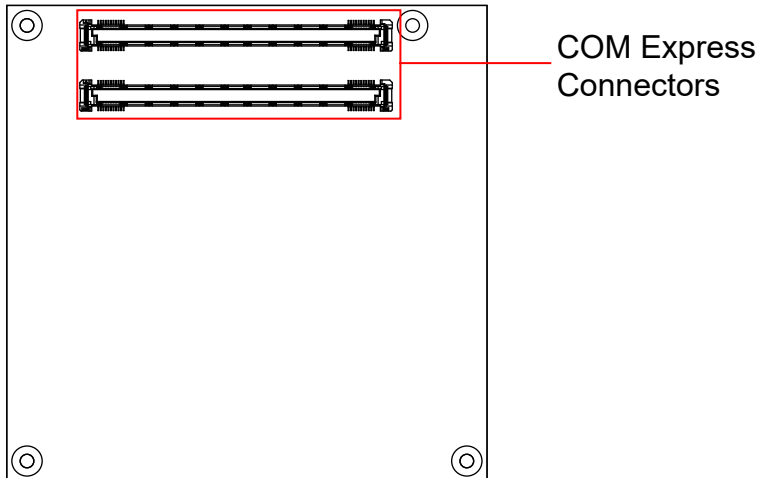

FAN1: Fan connector

Connector type: Wafer 3-pin 1.25mm 85204-03X0L

Pin	Description
1	GND
2	Fan out
3	Fan Tachometer Input



COM Express AB Connector (bottom side)

B1	GND	GND (FIXED)	A1	B56	PCIE_RXN6	PCIE_TXN6	A56
B2	LAN_LED_ACT#	LAN1_MDI3N	A2	B57	DIO_2	GND	A57
B3	LPC_FRAME#	LAN1_MDI3P	A3	B58	PCIE_RXP4	PCIE_TXP4	A58
B4	LPC_AD0	LAN_LED_100#	A4	B59	PCIE_RXN4	PCIE_TXN4	A59
B5	LPC_AD1	LAN_LED_1000#	A5	B60	GND	GND	A60
B6	LPC_AD2	LAN1_MDI2N	A6	B61	PCIE_RXP3	PCIE_TXP3	A61
B7	LPC_AD3	LAN1_MDI2P	A7	B62	PCIE_RXN3	PCIE_TXN3	A62
B8	LPC_LDRQ0-	LAN_LED_LNK#	A8	B63	DIO_3	DIO_1	A63
B9	LPC_LDRQ1-	LAN1_MDI1N	A9	B64	PCIE_RXP2	PCIE_TXP2	A64
B10	LPC_CLK	LAN1_MDI1P	A10	B65	PCIE_RXN2	PCIE_TXN2	A65
B11	GND	GND (FIXED)	A11	B66	PCH_WAKE#	GND	A66
B12	CB_PWRBTN#	LAN1_MDI0N	A12	B67	EC_WAKE_IN#	DIO_2	A67
B13	SMB_CLK	LAN1_MDI0P	A13	B68	PCIE_RXP1	PCIE_TXP1	A68
B14	SMB_DATA	0V9_LAN	A14	B69	PCIE_RXN1	PCIE_TXN1	A69
B15	SMB_ALERT#	SLP_S3#	A15	B70	GND	GND	A70
B16	SATA_TXP1	SATA_TXP0	A16	B71	LVDSB_DATA0	LVDSA_DATA0	A71
B17	SATA_TXN1	SATA_TXN0	A17	B72	LVDSB_DATA0-	LVDSA_DATA0-	A72
B18	SUS_STAT#	SLP_S4#	A18	B73	LVDSB_DATA1	LVDSA_DATA1	A73
B19	SATA_RXP1	SATA_RXP0	A19	B74	LVDSB_DATA1-	LVDSA_DATA1-	A74
B20	SATA_RXN1	SATA_RXN0	A20	B75	LVDSB_DATA2	LVDSA_DATA2	A75
B21	GND	GND (FIXED)	A21	B76	LVDSB_DATA2-	LVDSA_DATA2-	A76
B22	N/C	N/C	A22	B77	LVDSB_DATA3	LVDS_VDD_EN	A77
B23	N/C	N/C	A23	B78	LVDSB_DATA3-	LVDSA_DATA3	A78
B24	CB_PWROK	SLP_S5#	A24	B79	LVDS_BKLT_EN	LVDSA_DATA3-	A79
B25	N/C	N/C	A25	B80	GND	GND	A80
B26	N/C	N/C	A26	B81	LVDSB_CLK+	LVDSA_CLK+	A81
B27	WDT	PM_BATLOW#	A27	B82	LVDSB_CLK-	LVDSA_CLK-	A82
B28	N/C	SATALED-	A28	B83	COM_BKLT_CTRL	LVDS_DDC_CLK	A83
B29	HDA_SDIN1	HDA_SYNC	A29	B84	VCC_5V_SBY	LVDS_DDC_DATA	A84
B30	HDA_SDIN0	HDA_RST-	A30	B85	VCC_5V_SBY	DIO_3	A85
B31	GND	GND	A31	B86	VCC_5V_SBY	H_RCIN#	A86
B32	SPKR	HDA_BIT_CLK	A32	B87	VCC_5V_SBY	A20GATE	A87
B33	I2C_CLK	HDA_SDOUT	A33	B88	BIOS_DIS1#	COM_EXP_CLK_P	A88
B34	I2C_DAT	BIOS_DIS0#	A34	B89	N/C	COM_EXP_CLK_N	A89
B35	THRM#	CB_TRIP#	A35	B90	GND	GND	A90
B36	USBP_7N	USBP_6N	A36	B91	CRT_GREEN	+V3.3A	A91
B37	USBP_7P	USBP_6P	A37	B92	CRT_BLUE	SPI_MISO	A92
B38	USBOC_45-	USBOC_67-	A38	B93	CRT_HSYNC	DIO_0	A93
B39	USBP_5N	USBP_4N	A39	B94	CRT_VSYNC	SPI_CLK	A94
B40	USBP_5P	USBP_4P	A40	B95	CRT_DDC_CLK	SPI_MOSI	A95
B41	GND	GND	A41	B96	CRT_DDC_DATA	COM_TPM_PP	A96
B42	USBP_3N	USBP_2N	A42	B97	SPL_CS1#	N/C	A97
B43	USBP_3P	USBP_2P	A43	B98	N/C	UART_TX0	A98
B44	USBOC_01-	USBOC_23-	A44	B99	N/C	UART_RX0	A99
B45	USBP_1N	USBP_0N	A45	B100	GND	GND	A100
B46	USBP_1P	USBP_0P	A46	B101	FAN_PWMOUT	UART_TX1	A101
B47	PLTRST#_BUFF	VCC_RTC	A47	B102	FAN_TACHIN	UART_RX1	A102
B48	EXCD1_CCPE#	PLTRST#_BUFF	A48	B103	SLEEP#	LID#	A103
B49	CB_SYSRST#	EXCD0_CCPE#	A49	B104	VCC_12V	VCC_12V	A104
B50	CB_RESET#	LPC_SERIRQ	A50	B105	VCC_12V	VCC_12V	A105
B51	GND	GND	A51	B106	VCC_12V	VCC_12V	A106
B52	PCIE_RXP7	PCIE_TXP7	A52	B107	VCC_12V	VCC_12V	A107
B53	PCIE_RXN7	PCIE_TXN7	A53	B108	VCC_12V	VCC_12V	A108
B54	DIO_1	DIO_0	A54	B109	VCC_12V	VCC_12V	A109
B55	PCIE_RXP6	PCIE_TXP6	A55	B110	GND	GND	A110

COM Express CD Connector (bottom side)

D1	GND (FIXED)	GND (FIXED)	C1	D56	N/C	N/C	C56
D2	GND	GND	C2	D57	TYPE2#	N/C	C57
D3	USB_SSTX0-	USB_SSRX0-	C3	D58	N/C	N/C	C58
D4	USB_SSTX0+	USB_SSRX0+	C4	D59	N/C	N/C	C59
D5	GND	GND	C5	D60	GND (FIXED)	GND (FIXED)	C60
D6	USB_SSTX1-	USB_SSRX1-	C6	D61	N/C	N/C	C61
D7	USB_SSTX1+	USB_SSRX1+	C7	D62	N/C	N/C	C62
D8	GND	GND	C8	D63	N/C	N/C	C63
D9	USB_SSTX2-	USB_SSRX2-	C9	D64	N/C	N/C	C64
D10	USB_SSTX2+	USB_SSRX2+	C10	D65	N/C	N/C	C65
D11	GND (FIXED)	GND (FIXED)	C11	D66	N/C	N/C	C66
D12	USB_SSTX3-	USB_SSRX3-	C12	D67	N/C	N/C	C67
D13	USB_SSTX3+	USB_SSRX3+	C13	D68	N/C	N/C	C68
D14	GND	GND	C14	D69	N/C	N/C	C69
D15	DDI1_CTRLCLK_AUX+	N/C	C15	D70	GND (FIXED)	GND (FIXED)	C70
D16	DDI1_CTRLCLK_AUX-	N/C	C16	D71	N/C	N/C	C71
D17	N/C	RSVD	C17	D72	N/C	N/C	C72
D18	N/C	RSVD	C18	D73	GND	GND	C73
D19	PCIE_TX6+	PCIE_RX6+	C19	D74	N/C	N/C	C74
D20	PCIE_TX6-	PCIE_RX6-	C20	D75	N/C	N/C	C75
D21	GND(FIXED)	GND(FIXED)	C21	D76	GND	GND	C76
D22	PCIE_TX7+	PCIE_RX7+	C22	D77	N/C	N/C	C77
D23	PCIE_TX7-	PCIE_RX7-	C23	D78	N/C	N/C	C78
D24	N/C	DDI1_HPD	C24	D79	N/C	N/C	C79
D25	N/C	N/C	C25	D80	GND (FIXED)	GND (FIXED)	C80
D26	DDI1_PAIR0+	N/C	C26	D81	N/C	N/C	C81
D27	DDI1_PAIR0-	RSVD	C27	D82	N/C	N/C	C82
D28	N/C	RSVD	C28	D83	N/C	N/C	C83
D29	DDI1_PAIR1+	N/C	C29	D84	GND	GND	C84
D30	DDI1_PAIR1-	N/C	C30	D85	N/C	N/C	C85
D31	GND(FIXED)	GND (FIXED)	C31	D86	N/C	N/C	C86
D32	DDI1_PAIR2+	DDI2_CTRLCLK_AUX+	C32	D87	GND	GND	C87
D33	DDI1_PAIR2-	DDI2_CTRLCLK_AUX-	C33	D88	N/C	N/C	C88
D34	DDI1_DDC_AUX_SEL	DDI2_DDC_AUX_SEL	C34	D89	N/C	N/C	C89
D35	N/C	RSVD	C35	D90	GND (FIXED)	GND (FIXED)	C90
D36	DDI1_PAIR3+	N/C	C36	D91	N/C	N/C	C91
D37	DDI1_PAIR3-	N/C	C37	D92	N/C	N/C	C92
D38	N/C	N/C	C38	D93	GND	GND	C93
D39	DDI2_PAIR0+	N/C	C39	D94	N/C	N/C	C94
D40	DDI2_PAIR0-	N/C	C40	D95	N/C	N/C	C95
D41	GND(FIXED)	GND(FIXED)	C41	D96	GND	GND	C96
D42	DDI2_PAIR1+	N/C	C42	D97	N/C	N/C	C97
D43	DDI2_PAIR1-	N/C	C43	D98	N/C	N/C	C98
D44	DDI2_HPD	N/C	C44	D99	N/C	N/C	C99
D45	N/C	RSVD	C45	D100	GND (FIXED)	GND (FIXED)	C100
D46	DDI2_PAIR2+	N/C	C46	D101	N/C	N/C	C101
D47	DDI2_PAIR2-	N/C	C47	D102	N/C	N/C	C102
D48	N/C	RSVD	C48	D103	GND	GND	C103
D49	DDI2_PAIR3+	N/C	C49	D104	VCC_12V	VCC_12V	C104
D50	DDI2_PAIR3-	N/C	C50	D105	VCC_12V	VCC_12V	C105
D51	GND (FIXED)	GND (FIXED)	C51	D106	VCC_12V	VCC_12V	C106
D52	N/C	N/C	C52	D107	VCC_12V	VCC_12V	C107
D53	N/C	N/C	C53	D108	VCC_12V	VCC_12V	C108
D54	PEG_LANE_RV#	N/C	C54	D109	VCC_12V	VCC_12V	C109
D55	N/C	N/C	C55	D110	GND (FIXED)	GND (FIXED)	C110



Chapter 3

Installation & Maintenance

3.1 Installing the CPU Module to Carrier Board

1. Mount the EmETXe-i91M3 into PBE-1705 via COM Express connectors as below; that is, COM Express AB to AB and CD to CD.

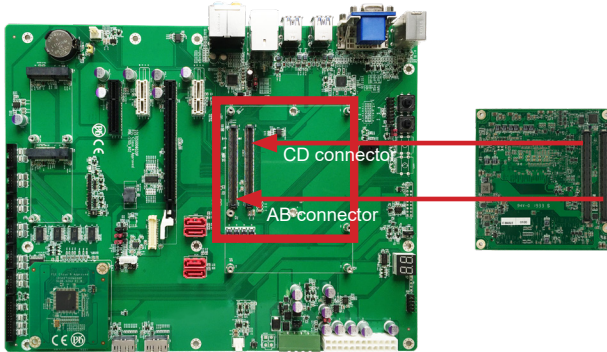

2. Install the optional heat spreader or heat sink with fan to the COM module.

For heat spreader

Apply thermal grease to the CPU area on the CPU module. Place the heat spreader over the CPU module and fasten the four screws to secure it in place.

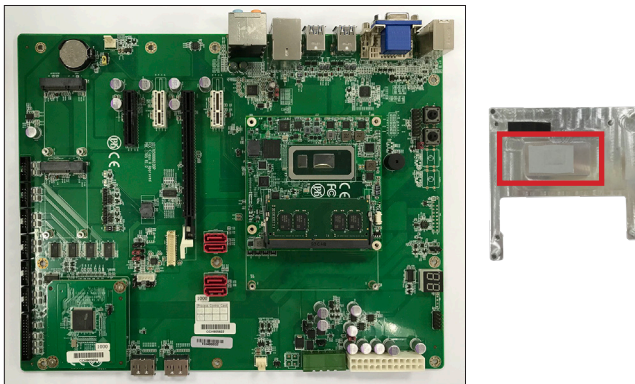

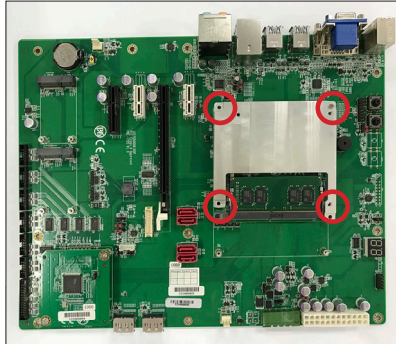

For heat sink with fan

Apply thermal grease to the CPU area on the CPU module. Place the heat sink over the CPU module and fasten the six screws to secure it in place.

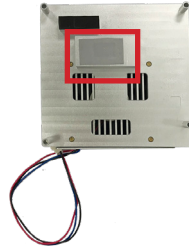
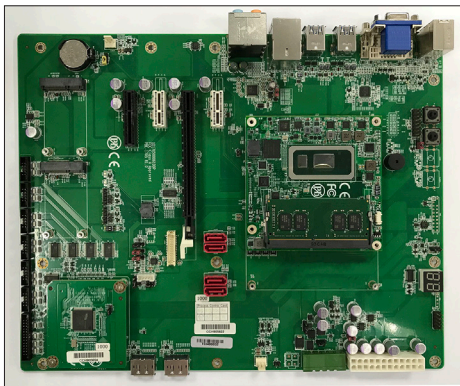

Then connect the fan cable to the fan connector on the carrier board.

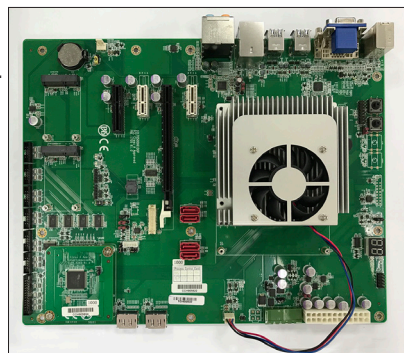

This page is intentionally left blank.



Chapter 4

BIOS

4.1 Main

The AMI BIOS provides a Setup utility program for specifying the system configurations and settings. The BIOS RAM of the system stores the Setup utility and configurations. When you turn on the computer, the AMI BIOS is immediately activated. To enter the BIOS SETUP UTILITY, press “Delete” once the power is turned on.

The **Main Setup** screen lists the following information:

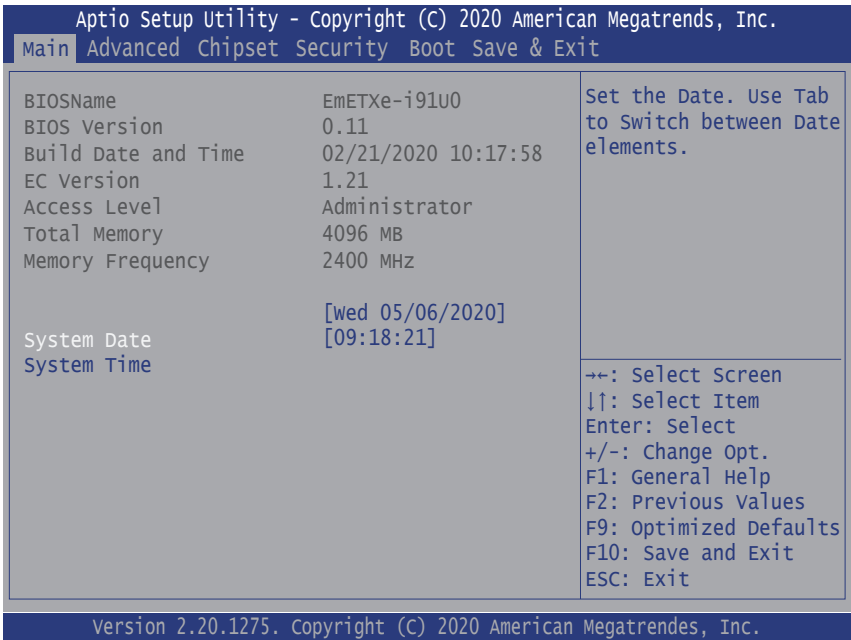

Setting	Description
System Language	Choose the system default language.
System Date	Set the system date. Use Tab to switch between Data elements. Note that the 'Day' automatically changes when you set the date. ► The date format is: Day: Sun to Sat Month: 1 to 12 Date: 1 to 31 Year: 1998 to 2099

System Time	<p>Set the system time. Use Tab to switch between Time elements.</p> <p>▶ The time format is: Hour: 00 to 23 Minute: 00 to 59 Second: 00 to 59</p>
-------------	---

Key Commands

BIOS Setup Utility is mainly a key-based navigation interface. Please refer to the following key command instructions for navigation process.

Keystroke	Function
◀ ▶	Move to highlight a particular configuration screen from the top menu bar / Move to highlight items on the screen
▼ ▲	Move to highlight previous/next item
Enter	Select and access a setup item/field
Esc	On the Main Menu – Quit the setup and not save changes into CMOS (a message screen will display and ask you to select “OK” or “Cancel” for exiting and discarding changes. Use “←” and “→” to select and press “Enter” to confirm) On the Sub Menu – Exit current page and return to main menu
Page Up / +	Increase the numeric value on a selected setup item / make change
Page Down / -	Decrease the numeric value on a selected setup item / make change
F1	Activate “General Help” screen
F10	Save the changes that have been made in the setup and exit. (a message screen will display and ask you to select “OK” or “Cancel” for exiting and saving changes. Use “←” and “→” to select and press “Enter” to confirm)

4.2 Advanced

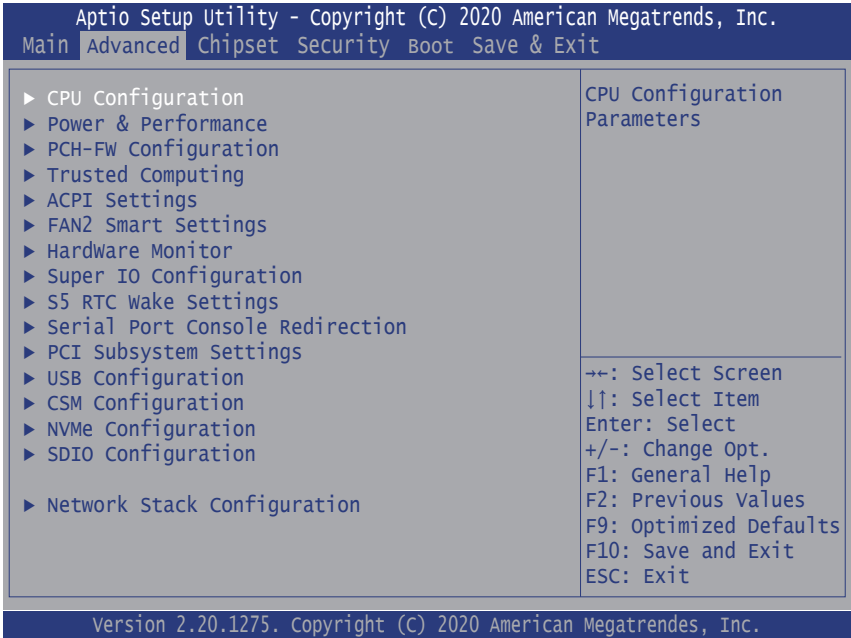

Setting	Description
CPU Configuration	See 4.2.1 CPU Configuration on page 24
Power & Performance	See 4.2.2 Power & Performance on page 25
PCH-FW Configuration	See 4.2.3 PCH-FW Configuration on page 26
Trusted Computing	See 4.2.4 Trusted Computing on page 27
ACPI Settings	See 4.2.5 ACPI Settings on page 28
FAN2 Smart Settings	See 4.2.6 FAN2 Smart Settings on page 29
Hardware Monitor	See 4.2.7 Hardware Monitor on page 30
Super IO Configuration	See 4.2.8 Super IO Configuration on page 31
S5 RTC Wake Settings	See 4.2.9 S5 RTC Configuration on page 34
Serial Port Console Redirection	See 4.2.10 Serial Port Console Redirection on page 35
PCI Subsystem Settings	See 4.2.11 PCI Subsystem Settings on page 37

USB Configuration	See 4.2.12 USB Configuration on page 38
CSM Configuration	See 4.2.13 CSM Configuration on page 40
NVMe Configuration	See 4.2.14 NVMe Configuration on page 41
SDIO Configuration	See 4.2.15 SDIO Configuration on page 42
Network Stack Configuration	See 4.2.16 Network Stack Configuration on page 43

4.2.1 CPU Configuration

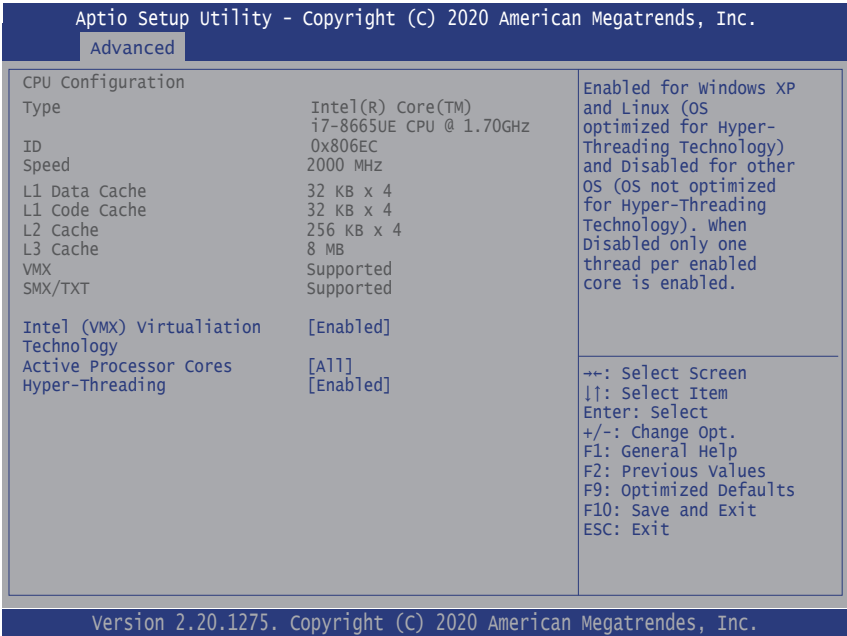

Setting	Description
Intel (VMX) Virtualization	Enable or disable Intel virtualization technology. When enabled, a VMM can utilize the additional hardware capabilities provide by Vanderpool Technology. ▶ Options: Enabled (default) or Disabled
Active Processor Cores	Number of cores to enable in each processor package. ▶ Options: All (default), 1 , 2 and 3
Hyper-threading	Enabled (default) for Windows and Linux (OS optimized for Hyper-Threading Technology) and Disabled for other OS (OS not optimized or Hyper-Threading Technology). When disabled only one thread per enabled core is enabled.

4.2.2 Power & Performance

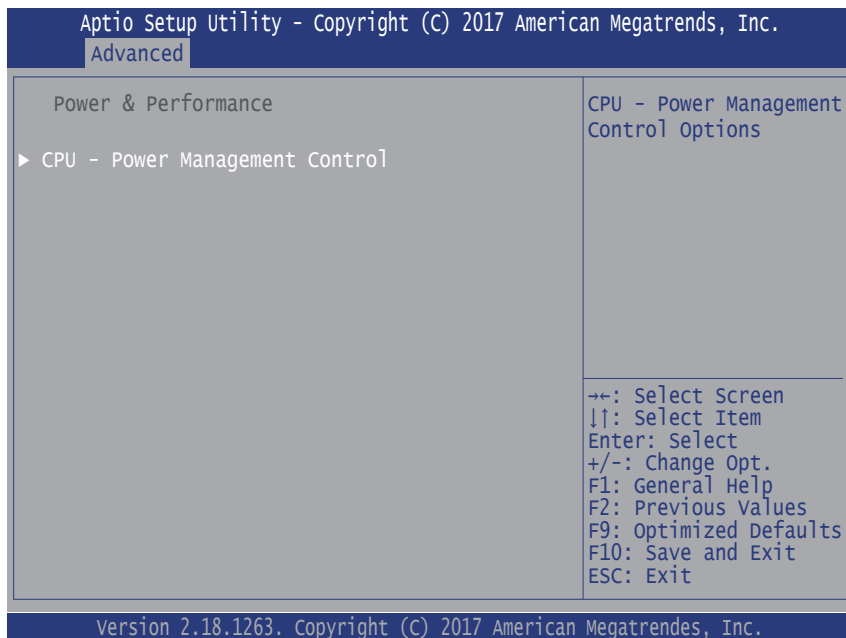

Setting	Description
Boot performance Mode	Set the performance state that the BIOS will set before the OS handoff. ▶ Options: Max Non-Turbo Performance (default), Max Power Saving and Turbo Performance
Intel (R) Speed Step (tm)	Enable (default)/ Disable processor Turbo Mode (requires Intel SpeedStep or Intel Speed Shift to be available and enabled).
Turbo Mode	Enable (default)/ Disable Intel SpeedStep. Allows more than two frequency ranges to be supported.
C States	Enable /Disable (default) CPU C States

4.2.3 PCH-FW Configuration

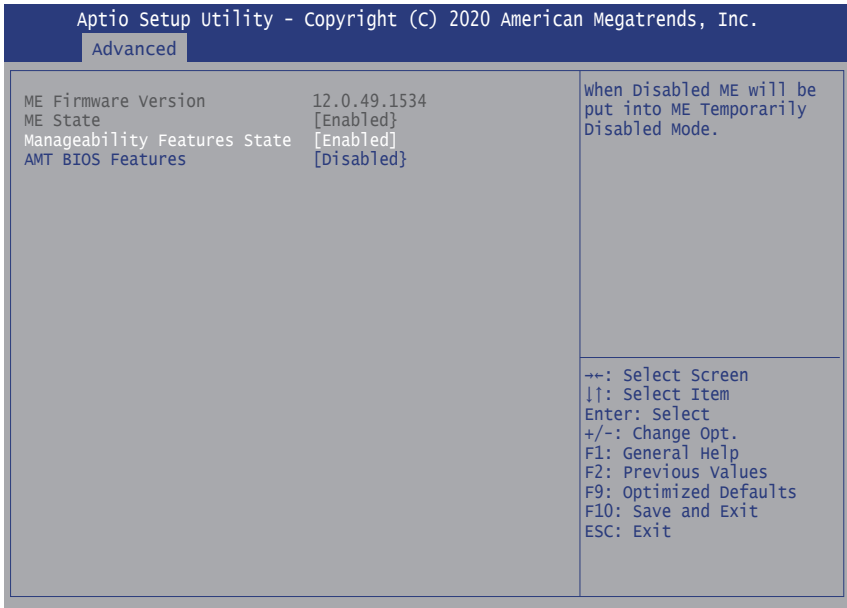

Setting	Description
ME State	Enable / Disable (Default) ME state. When disabled, ME will be put into ME Temporarily Disabled Mode.
Manageability Features State	Enable (Default) / Disable Intel (R) Manageability features support in FW. To disable support platform must be in an unprovisioned state first.
AMT BIOS Features	Enable / Disable (default) AMT BIOS features. When disabled, AMT BIOS features are no longer supported and user is no longer able to access MEBx Setup. Note: This option doesn't disable Manageability Features in FW.

4.2.4 Trusted Computing

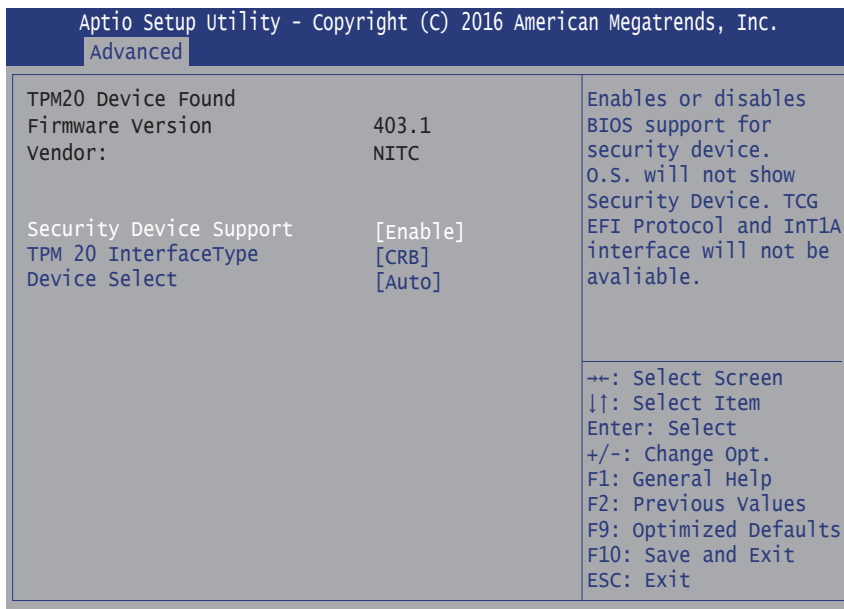

Setting	Description
Security Device Support	Enable (default) or Disable BIOS support for security device. O.S. will not show Security Device. TCG EFI protocol and INT1A interface will not be available.
Device Select	Select the TPM device: Options: TPM 1.2 , TPM 2.0 and Auto (default) <ul style="list-style-type: none"> ▶ TPM 1.2 will restrict support to TPM 1.2 devices ▶ TPM 2.0 will restrict support to TPM 2.0 devices ▶ Auto will support both with the default set to TPM 2.0 devices if not found., TPM 1.2 device will be enumerated.

4.2.5 ACPI Settings

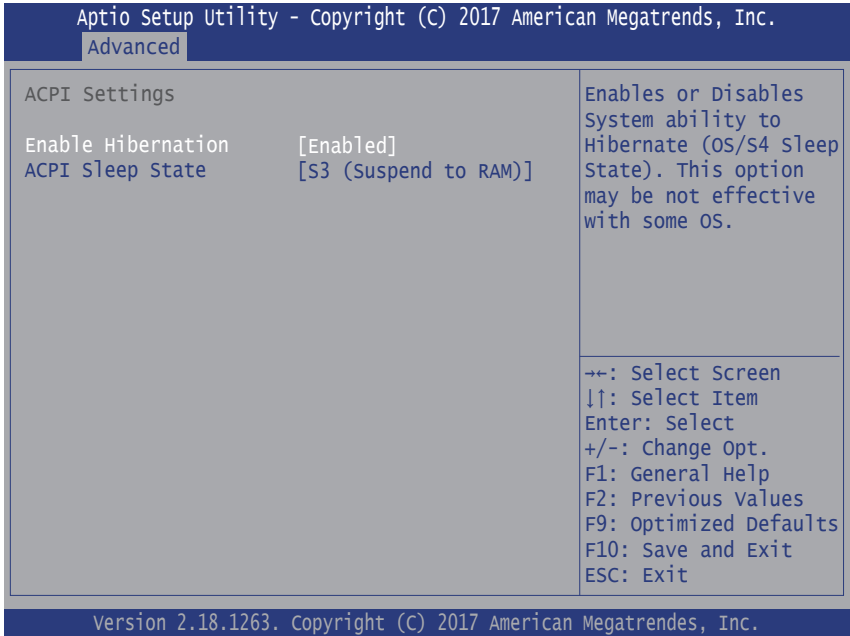

Setting	Description
Enable Hibernation	Enable (default) or Disable System ability to Hiber-nate (OS/S4 Sleep State). This option may be not effective with some OS.
ACPI Sleep State	Select the highest ACPI sleep state the system will enter when the SUSPEND button is pressed. ► Options: Suspend Disabled and S3 (Suspend to RAM) (default).

4.2.6 FAN2 Smart Settings

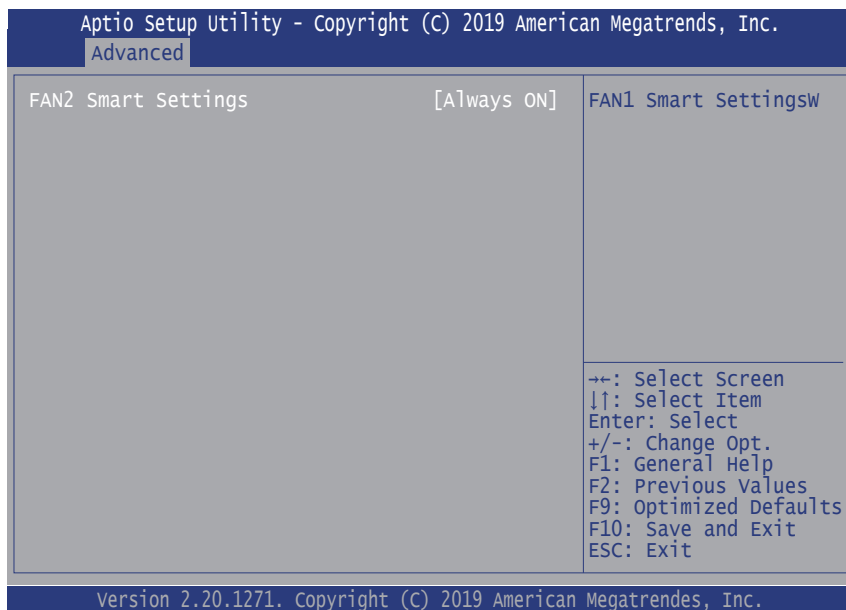

Setting	Description
FAN2 Smart Settings	Select the Smart Fan function. ► Options: Smart FAN , Always ON (default), Always OFF and None FAN .

4.2.7 Hardware Monitor

The screenshot shows the 'Advanced' submenu of the Aptio Setup Utility. The title bar reads 'Aptio Setup Utility - Copyright (C) 2017 American Megatrends, Inc.' and the submenu is titled 'Advanced'. The main content area is divided into two sections. The left section, titled 'PC Health Status', lists several hardware metrics: CPU Temperature at +37°C, Fan1 Speed at 5269 RPM, Fan2 Speed at N/A, VCore at +0.858 V, VCCDU at +1.189 V, and VIN at +11.942 V. The right section contains a list of navigation and function keys: ++ for Select Screen, ↓↑ for Select Item, Enter for Select, +/- for Change Opt., F1 for General Help, F2 for Previous Values, F9 for Optimized Defaults, F10 for Save and Exit, and ESC for Exit. The footer of the window displays 'Version 2.18.1263. Copyright (C) 2017 American Megatrends, Inc.'

```
Aptio Setup Utility - Copyright (C) 2017 American Megatrends, Inc.
Advanced

PC Health Status

CPU Temperature           : +37°C
Fan1 Speed                : 5269 RPM
Fan2 Speed                : N/A
VCore                    : +0.858 V
VCCDU                    : +1.189 V
VIN                      : +11.942 V

--: Select Screen
↓↑: Select Item
Enter: Select
+/-: Change Opt.
F1: General Help
F2: Previous Values
F9: Optimized Defaults
F10: Save and Exit
ESC: Exit

Version 2.18.1263. Copyright (C) 2017 American Megatrends, Inc.
```

Access this submenu to monitor the hardware status.

4.2.8 Super IO Configuration

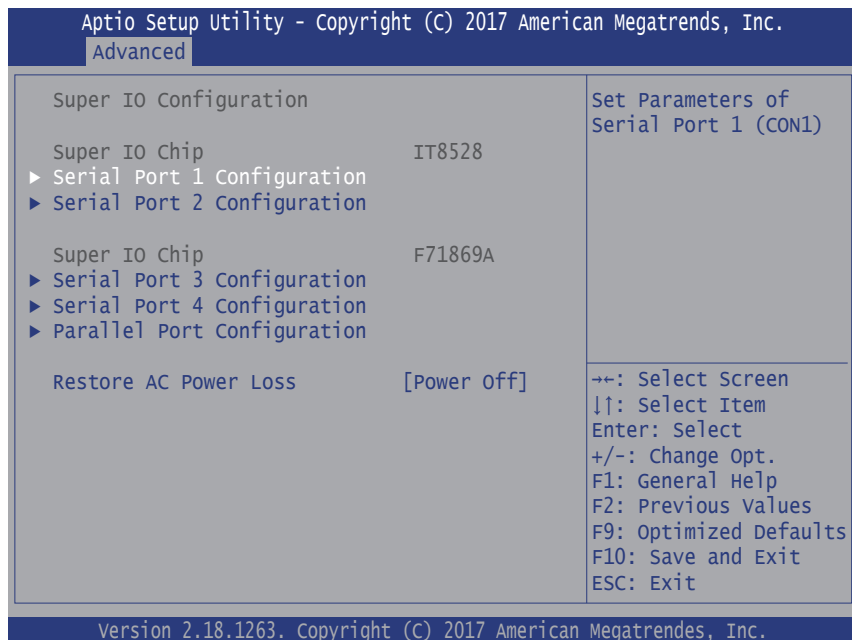

Setting	Description
Serial Port 1/2/3/4 & Parallel Port Configuration	See next page.
Restore AC Power Loss	Specify what state to go to when power is re-applied after a power failure. <ul style="list-style-type: none"> ▶ Options: Last State, Power On and Power Off (default)

Serial Port 1/2/3/4 Configuration

Setting	Description
Serial Port	Enable (default) or Disable Serial Port (COM).
Change Settings	<p>Select an optimal setting for Super IO device.</p> <ul style="list-style-type: none"> ▶ Options for Serial Port 1: Auto; IO=3E8h; IRQ=11 (default) ; IO=3E8h; IRQ=5, 7, 10, 11, 12 IO=2E8h; IRQ=5, 7, 10, 11, 12 ▶ Options for Serial Port 2: Auto IO=2E8h; IRQ=10 (default) IO=3E8h; IRQ=5, 7, 10, 11, 12 IO=2E8h; IRQ=5, 7, 10, 11, 12 ▶ Options for Serial Port 3: Auto IO=3F8h; IRQ=4 (default) IO=2F8h; IRQ=3, 4, 5, 7, 12 IO=3F8h; IRQ=3, 4, 5, 7, 12 ▶ Options for Serial Port 4: Auto IO=2F8h; IRQ=3 (default) IO=3F8h; IRQ=3, 4, 5, 7, 12 IO=2F8h; IRQ=3, 4, 5, 7, 12

Parallel Port Configuration

Setting	Description
Parallel Port	Enable (default) or Disable Parallel Port (LPT/LPTE).
Change Settings	Select an optimal setting for Super IO device. ▶ Options: Auto IO=378h; IRQ=7 (default) IO=378h; IRQ=5, 7, 12 IO=278h; IRQ=5, 7, 12 IO=3BCh; IRQ=5, 7, 12
Device Mode (only for Parallel Port Configuration)	Change the Printer Port mode. ▶ Options: STD Printer Mode (default) SPP Mode EPP-1.9 and SPP Mode EPP-1.7 and SPP Mode ECP Mode ECP and EPP 1.9 Mode ECP and EPP 1.7 Mode.

4.2.9 S5 RTC Configuration

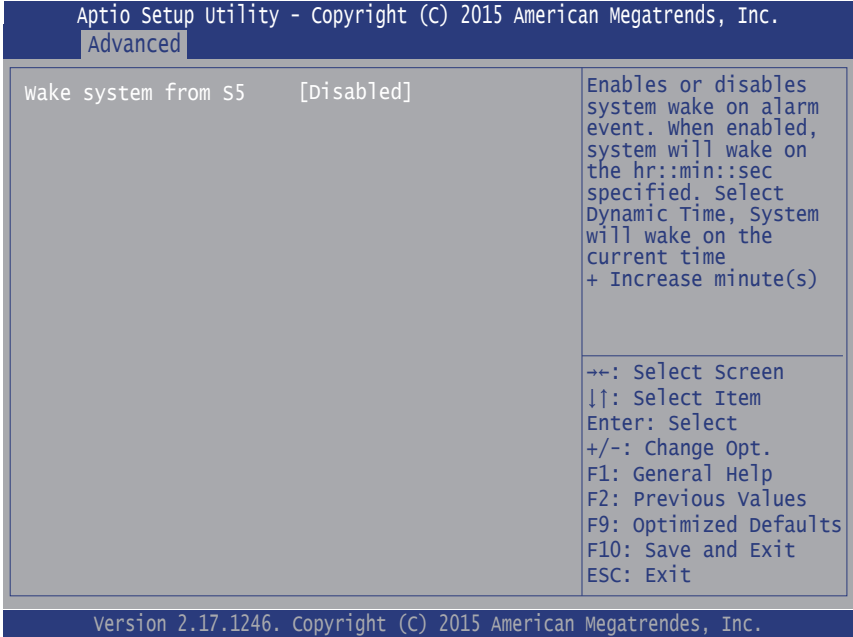

Setting	Description
Wake System from S5	<p>Enable or Disable (default) system wake on alarm event.</p> <ul style="list-style-type: none"> Options available are: <ul style="list-style-type: none"> Disabled (default): Fixed Time: System will wake on the hr::min::sec specified. DynamicTime: If selected, you need to set Wake up minute increase from 1 - 5. System will wake on the current time + increase minute(s).

4.2.10 Serial Port Console Redirection

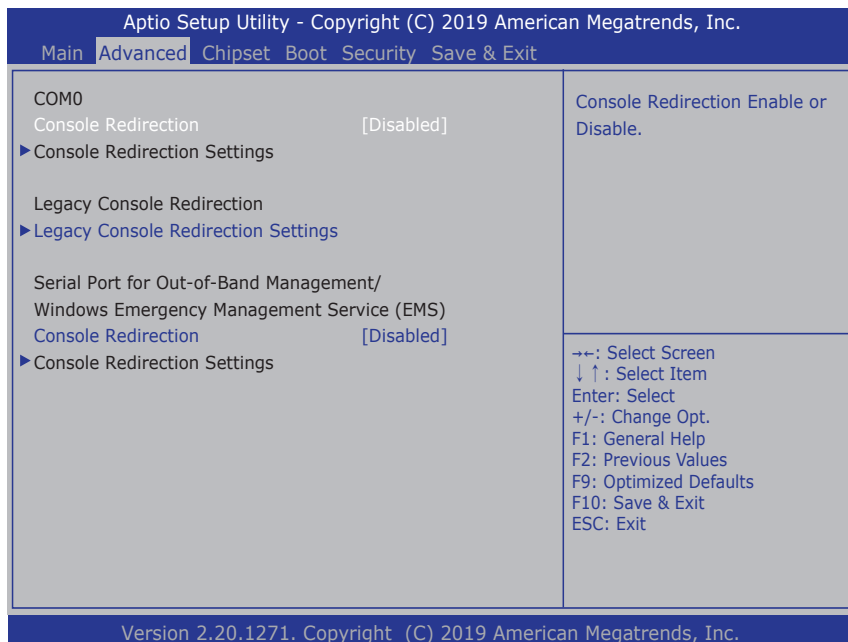

Setting	Description
Console Redirection	Enable or Disable (default) console redirection. Following submenu is available only when Console Redirection is set to Enabled .
Legacy Console Redirection Settings	
Redirection COM Port	Select a COM port to display redirectino of Legacy OS and Legacy OPROM message. ▶ COM0 is the default.
Resolution	On legacy OS, the Number of Rows and Columns supported redirection. ▶ 80x24 is the default.

Redirect After POST	<p>When Bootloader is selected, then Legacy Console Redirection is disabled before booting to legacy OS. When Always Enable is selected, then Legacy Console Redirection is enabled for legacy OS. Default setting for this option is set to Always Enable</p> <ul style="list-style-type: none">▶ Options available are:<ul style="list-style-type: none">Always Enable(default): set the Redirection to be always activeBoot Loader: set the Redirection to be active during POST and Boot Loader
Console Redirection	<p>Enables/Disables console redirection.</p> <ul style="list-style-type: none">▶ Disabled is the default.

4.2.11 PCI Subsystem Settings

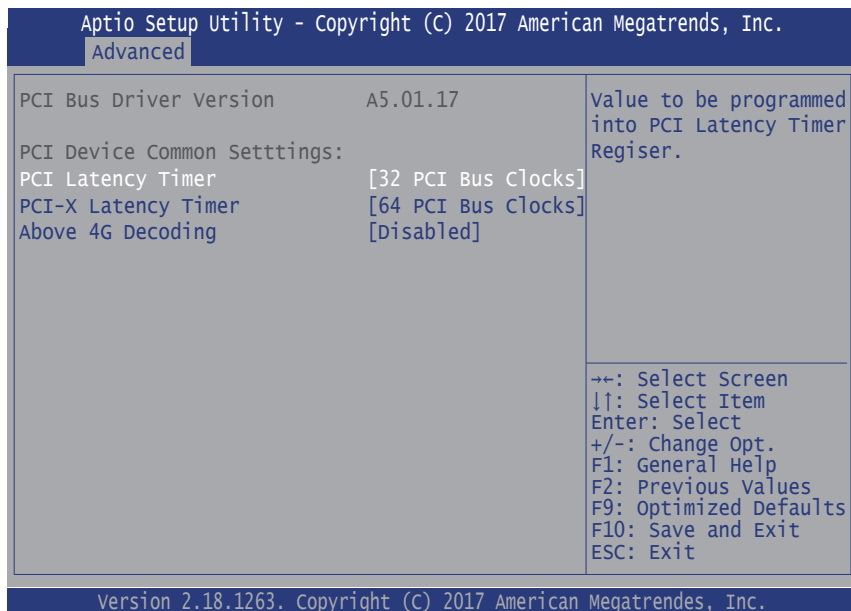

Setting	Description
PCI Latency Timer	Value to be programmed into PCI Latency timer Register. ▶ Default: 32 PCI Bus Clocks
PCI-X Latency Timer	Value to be programmed into PCI Latency timer Register. ▶ Default: 64 PCI Bus Clocks
Above 4G Decoding	Enable/Disable (default) 64bit capable Devices to be Decoded in Above 4G Address Space (Only if System Supports 64 bit PCI Decoding).

4.2.12 USB Configuration

Aptio Setup Utility - Copyright (C) 2020 American Megatrends, Inc.
Advanced

USB Configuration		Enables Legacy USB support. AUTO option disables legacy support if no USB devices are connected. DISABLE option will keep USB devices available only for EFI applications.
USB Module Version	23	
USB Devices:	1 XHCI	
USB Devices:	1 Keyboard	
Legacy USB Support	[Enabled]	→←: Select Screen ↓↑: Select Item Enter: Select +/-: Change Opt. F1: General Help F2: Previous Values F9: Optimized Defaults F10: Save and Exit ESC: Exit
XHCI Hand-off	[Disabled]	
USB Mass Storage Driver Support	[Enabled]	
USB hardware delays and time-outs:		
USB Transfer time-out	[20 sec]	
Device reset time-out	[20 sec]	
Device power-up delay	[Auto]	

Version 2.20.1275. Copyright (C) 2020 American Megatrends, Inc.

Setting	Description
Legacy USB Support	Sets legacy USB support. ► Options: Enabled (default), Disabled and Auto . AUTO option disables legacy support if no USB devices are connected. Disable option will keep USB devices available only for EFI applications.
XHCI Hand-off	Enable (default) or Disable XHCI Hand-off This is a workaround for Oses without XHCI hand-off support. The XHCI ownership change should be claimed by XHCI driver.
USB Mass Storage Driver Support	Enable (default) or Disable USB Mass Storage Driver Support.

USB hardware delay and time-out	
USB Transfer time-out	<p>Use this item to set the time-out value for control, bulk, and interrupt transfers.</p> <ul style="list-style-type: none">Options available are: 1 sec, 5 sec, 10 sec, 20 sec (default)
Device reset time-out	<p>Use this item to set USB mass storage device start unit command time-out.</p> <ul style="list-style-type: none">Options available are: 10 sec, 20 sec (default), 30 sec, 40 sec
Device power-up delay	<p>Use this item to set maximum time the device will take before it properly reports itself to the host controller.</p> <ul style="list-style-type: none">Options available are: Auto (Default): 'Auto' uses default value: for a root port it is 100 ms, for a hub port the delay is taken from hub descriptor. Manual: Select Manual you can set value for the following sub-item: 'Device Power-up delay in seconds', the delay range in from 1 to 40 seconds, in one second increments.

4.2.13 CSM Configuration

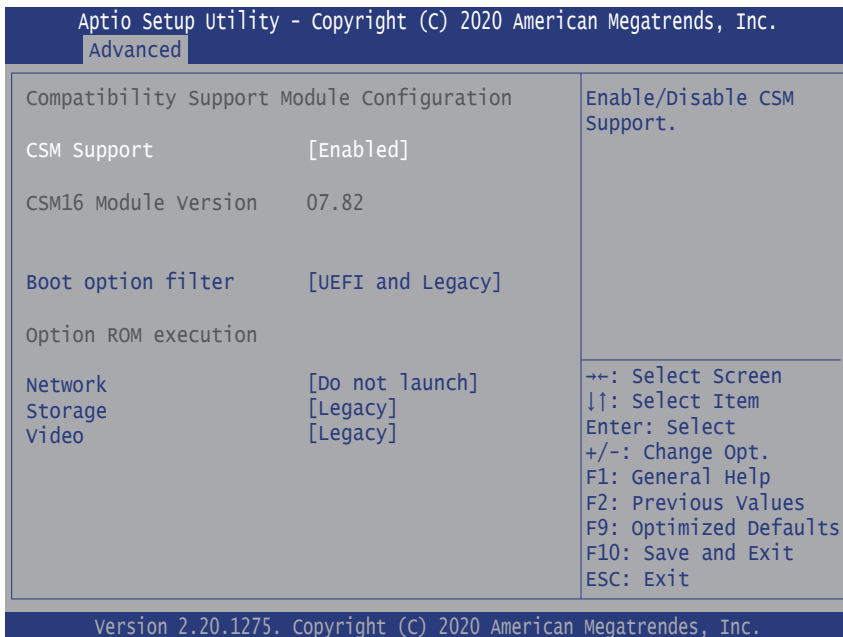

Setting	Description
CSM Support	Enable (default) or Disable CSM Support.
Boot option filter	Control the Legacy/UEFI ROMs priority. ▶ Options: UEFI and Legacy (default), Legacy only and UEFI only
Network	Control the execution of UEFI and Legacy PXE OpROM ▶ Options: Do not lauch (default), UEFI and Legacy
Storage	Control the execution of UEFI and Legacy Storage OpROM ▶ Options: Do not lauch , UEFI and Legacy (default)
Video	Control the execution of UEFI and Legacy Video OpROM ▶ Options: Do not lauch , UEFI and Legacy (default)

4.2.14 NVMe Configuration

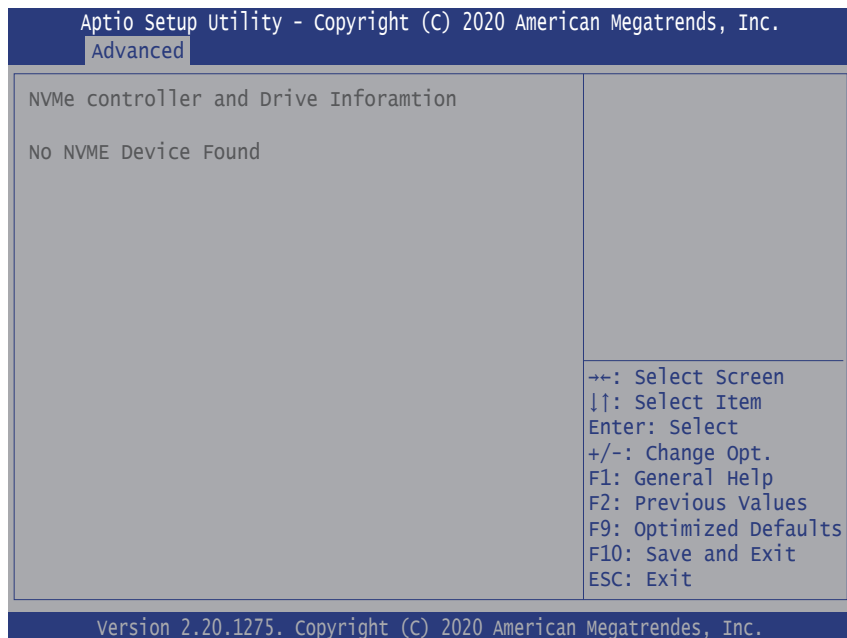

Access this submenu to view the NVMe controller and driver information.

4.2.15 SDIO Configuration

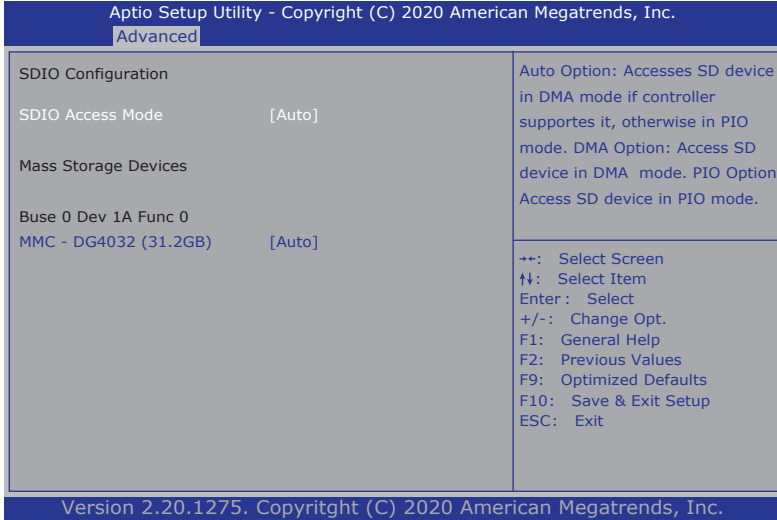

Setting	Description
SDIO Access Mode	Configures SDIO Access Mode. Options: <ul style="list-style-type: none"> ▶ Auto: Access SD device in DMA mode if controller supports it, otherwise in PIO mode. ▶ ADMA/SDMA: Access SD device in DMA mode. ▶ PIO: Access SD device in PIO mode.
MMC - DG4032 (31.2GB)	Mass storage device emulation type. “Auto” enumerates devices less than 530MB as floppies. Force FDD option can be used to force HDD formatted drive to boot as FDD. <ul style="list-style-type: none"> ▶ Options: Auto (default), Floppy, Forced FDD and Hard Disk

4.2.16 Network Stack Configuration

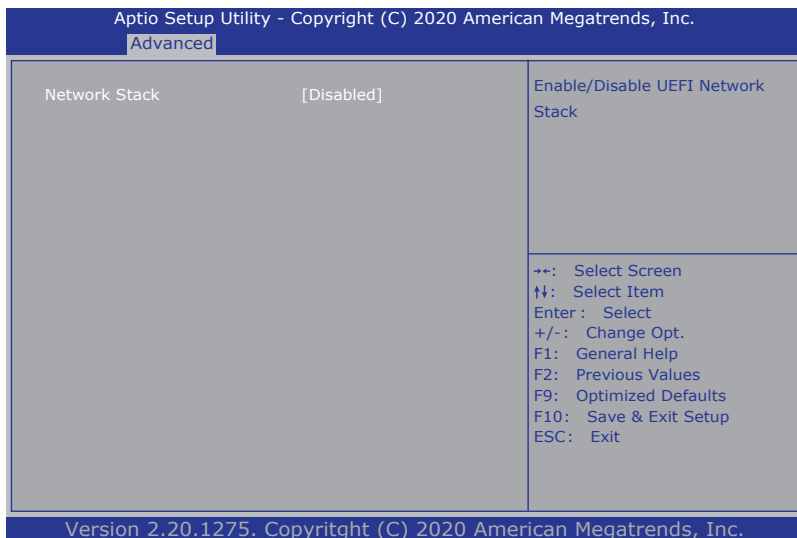

Setting	Description
Network Stack	Enables/disables UEFI network stack. ▶ Disabled is the default.

4.3 Chipset

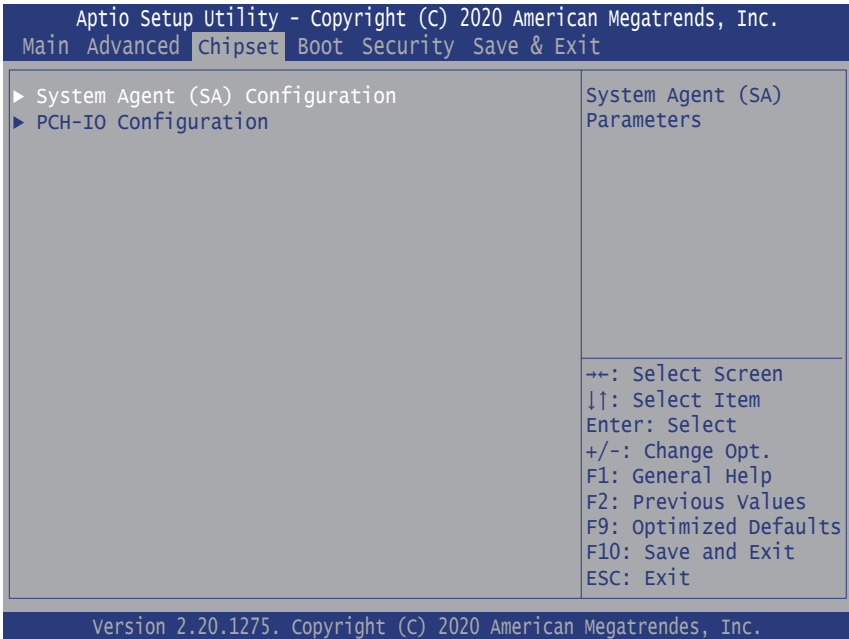

Setting	Description
System Agent (SA) Configuration	See 4.3.1 System Agent (SA) Configuration on page 45
PCH-IO Configuration	See 4.3.2 PCH-IO Configuration on page 47

4.3.1 System Agent (SA) Configuration

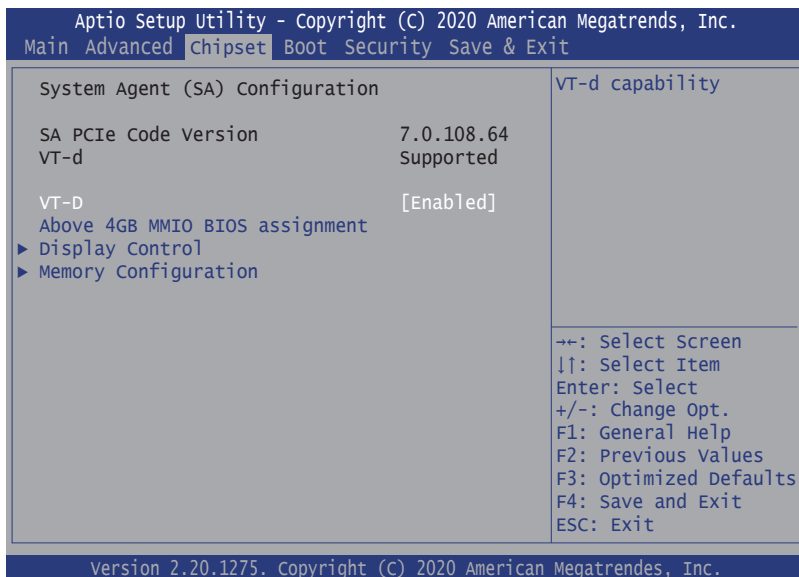

Setting	Description
VT-d	Enable (default) or Disable VT-d function
Above 4GB MMIO BIOS assignment	Enable or Disable (default) Above 4GB MmemoryMapped BIOS assignment. This is automatically enabled when Aperture Size is set to 2048MB.
Display Control	
Primary IGFX Boot Display	Select the Video Device which will be activated during POST. This has no effect if external graphics present. Secondary boot display selection will appear based on your selection. VGA modes will be supported only on primary display. ▶ Options: VBIOS Default (default), LFP , EFP2 , EFP and EFP3 .

Active LFP	Configuring LFP usage ▶ Options: No eDP (default) and eDP Port-A
Memory Configuration	Access this submenu to view the memory configuration.

4.3.2 PCH-IO Configuration

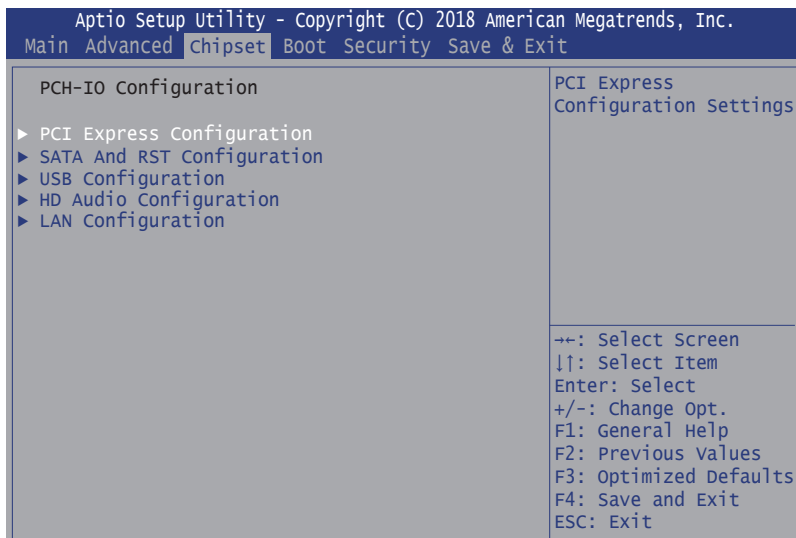

Setting	Description
PCI Express Configuration	See 4.3.2.1 PCI Express Configuration on page 48
SATA Configuration	See 4.3.2.2 SATA Configuration on page 48
USB Configuration	See 4.3.2.3 USB Configuration on page 49
HD Audio Configuration	See 4.3.2.4 HD Audio Configuration on page 49
PCH LAN Controller	See 4.3.2.5 PCH LAN Controller on page 49

4.3.2.1 PCI Express Configuration

Setting	Description
PCIE1, 2 3 & MC1, 2	Enable (default) or disable PCIE3/1/2 and MC1/2.
Topology	Identify the SATA Topology if it is default, ISATA , Flex, DirectConnect or M2. ▶ Options: Basic specific, Unknown, x1 (default), x4, Sata Express and M2
ASPM	Disable or set the ASPM level. Force L0s will force all inks to L0s state. "Auto" will allow BIOS to auto configure."Disable" will disable ASPM. ▶ Options: Disabled (default), L0s, L1, L0sL1 and Auto .
Hot Plug	Enable or disable (default) PCI Express Hot Plug.
PCIe Speed	Select PCI Express port speed. ▶ Options: Auto (default), Gen1, Gen2 and Gen3

4.3.2.2 SATA Configuration

Setting	Description
SATA Controller`s	Enable (default) or disable SATA Device.
SATA Mode Selection	Determines how SATA controller(s) operate. ▶ Options: AHCI (default) and RAID
Port 0/1	Enable or disable (default) SATA Port.
Hot Plug	Enable or disable (default) the port as pluggable.
SATA Device Type	Identify the SATA port is connected to Solid State Drive or hard Disk Drive. ▶ Options: Hard Disk Drive and Solid State Drive (default).

4.3.2.3 USB Configuration

Setting	Description
USB Port Disable Override	<p>Selectively enable/disable (default) the corresponding USB port from reporting a Device Connection to the controller.</p> <ul style="list-style-type: none"> ▶ Options: Disable Link (default) and Select Per-Pin

4.3.2.4 HD Audio Configuration

Setting	Description
HD Audio Configuration	<p>Control Detection of the HD-Audio device.</p> <ul style="list-style-type: none"> ▶ Options available are: Disabled: HDA will be unconditionally disabled Enabled (default): HDA will be unconditionally Enabled

4.3.2.5 PCH LAN Controller

Setting	Description
PCH LAN Controller	<p>Enables/Disables onboard NIC.</p> <ul style="list-style-type: none"> ▶ Options: Enabled (default) and Disabled If enabled, "Wake on LAN" option will be available to Enable (default) / Disable integrated LAN to wake the system. (the Wake On LAN cannot be disabled if ME is on at Sx state.)

4.4 Security

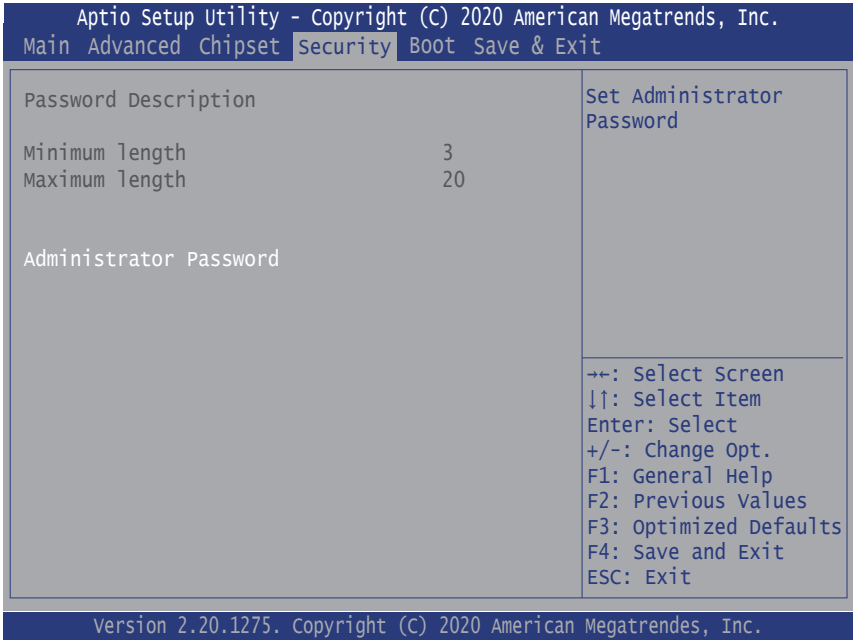

Setting	Description
Administrator Password	<p>To set up an administrator password:</p> <ol style="list-style-type: none"> 1. Select Administrator Password. The screen then pops up an Create New Password dialog. 2. Enter your desired password that is no less than 3 characters and no more than 20 characters. 3. Hit [Enter] key to submit.

4.5 Boot

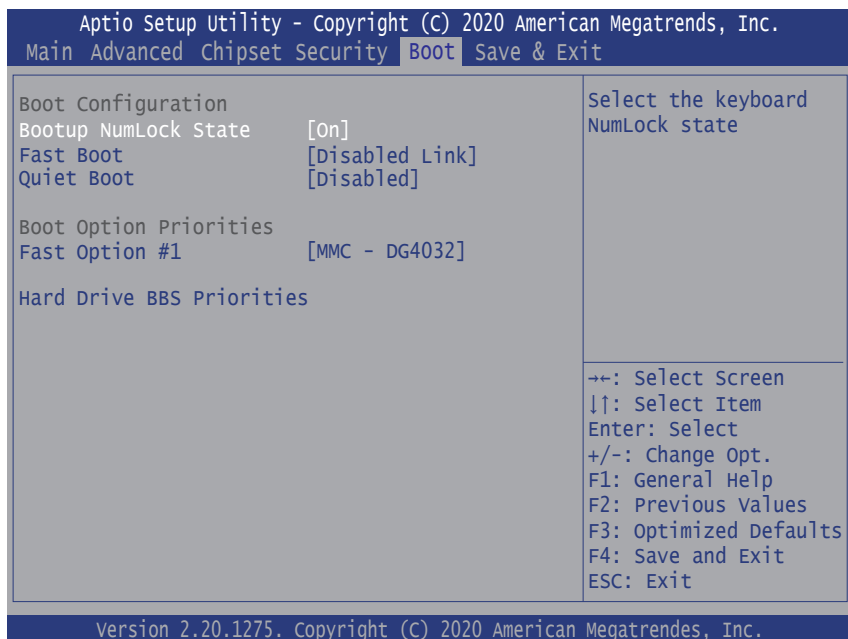

Setting	Description
Boot NumLock State	Select the keyboard NumLock state. ► Options: On (default) and Off .
Fast Boot	Enable or Disable (default) boot with initialization of a minimal set of devices required to launch active boot option. Has no effect for BBS boot options.
Quiet Boot	Enable (default) or Disable Quiet Boot option.
Boot Option Priority	Set the system boot priorities.
Hard Drive BBS Priorities	BBS means “BIOS Boot Specification”. Sets the order of the legacy devices in this group.

4.6 Save & Exit

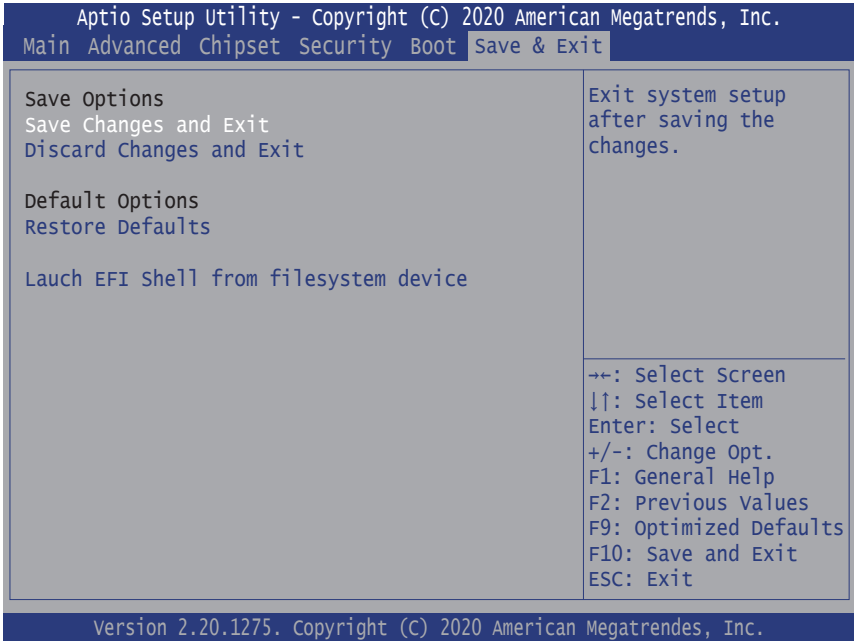

Setting	Description
Save Changes and Exit	Exit system setup after saving the changes. ▶ Enter the item and then a dialog box pops up: Save configuration and exit? (Yes/ No)
Discard Changes and Exit	Exit system setup without saving the changes. ▶ Enter the item and then a dialog box pops up: Quit without saving? (Yes/ No)
Restore Defaults	Restore/Load Default values for all the setup options. ▶ Enter the item and then a dialog box pops up: Load Optimized Defaults? (Yes/ No)
Launch EFI Shell from filesystem device	Attempts to launch EFI shell application (Shell.efi) from one of the available filesystem devices.



Appendix

Appendix A: I/O Port Address Map

Each peripheral device in the system is assigned a set of I/O port addresses which also becomes the identity of the device. The following table lists the I/O port addresses used.

Address	Device Description
03F8-03FF	Communications Port (COM1)
02F8-02FF	Communications Port (COM2)
03E8-03EF	Communications Port (COM3)
02E8-02EF	Communications Port (COM4)
002E-002F	Motherboard resources
004E-004F	Motherboard resources
0061-0061	Motherboard resources
0070-0071	Motherboard resources
0080-0080	Motherboard resources
0092-0092	Motherboard resources
00B2-00B3	Motherboard resources
1800-18FE	Motherboard resources
0A00-0A1F	Motherboard resources
0A20-0A2F	Motherboard resources
0A30-0A3F	Motherboard resources
0CF8-0CFF	PCI Express Configuration Access Port
0378-037F	Printer Port (LPT1)
0020-0021	Programmable interrupt controller
00A0-00A1	Programmable interrupt controller
04D0-04D1	Programmable interrupt controller
F040-F05F	SM Bus Controller
F090-F097	Standard SATA AHCI Controller
F080-F083	Standard SATA AHCI Controller
F060-F07F	Standard SATA AHCI Controller
0040-0043	System timer

Appendix B: BIOS Memory Mapping

Address	Device Description
0xDF000000-0xDF01FFFF	Ethernet Controller
0xDF040000-0xDF043FFF	High Definition Audio Controller
0xDF020000-0xDF02FFFF	High Definition Audio Controller
0xFED00000-0xFED003FF	High Precision Event Timer
0xFF000000-0xFFFFFFFF	Intel(R) 82802 Firmware Hub Device
0xDF030000-0xDF03FFFF	Intel(R) USB 3.0 eXtensible Host Controller - 0100 (Microsoft)
0xA0000-0xBFFFF	Microsoft Basic Display Adapter
0xDE000000-0xDEFFFFFF	Microsoft Basic Display Adapter
0xC0000000-0xCFFFFFFF	Microsoft Basic Display Adapter
0xFED10000-0xFED17FFF	Motherboard resources
0xFED18000-0xFED18FFF	Motherboard resources
0xFED19000-0xFED19FFF	Motherboard resources
0xE0000000-0xEFFFFFFF	Motherboard resources
0xFED20000-0xFED3FFFF	Motherboard resources
0xFED90000-0xFED93FFF	Motherboard resources
0xFED45000-0xFED8FFFF	Motherboard resources
0xFF000000-0xFFFFFFFF	Motherboard resources
0xFEE00000-0xFEEFFFFFFF	Motherboard resources
0xDFFE0000-0xDFFFFFFF	Motherboard resources
0xFE029000-0xFE029FFF	Motherboard resources
0xFE028000-0xFE028FFF	Motherboard resources
0xFDAF0000-0xFDAFFFFF	Motherboard resources
0xFDAE0000-0xFDAEFFFF	Motherboard resources
0xFDAC0000-0xFDACFFFF	Motherboard resources
0xFD000000-0xFDABFFFF	Motherboard resources
0xFDAD0000-0xFDADFFFF	Motherboard resources
0xFDB00000-0xFDFFFFFFFF	Motherboard resources
0xFE000000-0xFE01FFFF	Motherboard resources

Appendix

0xFE036000-0xFE03BFFF	Motherboard resources
0xFE03D000-0xFE3FFFFFFF	Motherboard resources
0xFE410000-0xFE7FFFFFFF	Motherboard resources
0xDF051000-0xDF051FFF	PCI Data Acquisition and Signal Processing Controller
0xFD000000-0xFDABFFFF	PCI Express Root Complex
0x90000000-0xDFFFFFFF	PCI Express Root Complex
0xDF044000-0xDF047FFF	PCI Memory Controller
0xDF04B000-0xDF04BFFF	SDA Standard Compliant SD Host Controller
0xDF04A000-0xDF04A0FF	SM Bus Controller
0xDF048000-0xDF049FFF	Standard SATA AHCI Controller
0xDF04E000-0xDF04E0FF	Standard SATA AHCI Controller
0xDF04D000-0xDF04D7FF	Standard SATA AHCI Controller
0xFED40000-0xFED40FFF	Trusted Platform Module 1.2

Appendix C: Interrupt Request Lines (IRQ)

Peripheral devices use interrupt request lines to notify CPU for the service required. The following table shows the IRQ used by the devices on board.

Level	Function
IRQ0	System timer
IRQ1	PS/2 Keyboard
IRQ3	Communications Port (COM2)
IRQ4	Communications Port (COM1)
IRQ5	SM Bus Controller
IRQ8	System CMOS/real time clock
IRQ10	Communications Port (COM4)
IRQ11	Communications Port (COM3)
IRQ12	PS/2 Mouse
IRQ16~IRQ23	PCIe Devices

Appendix D: Watchdog Timer (WDT) Setting

WDT is widely used for industry application to monitor the activity of CPU. Application software depends on its requirement to trigger WDT with adequate timer setting. Before WDT time out, the functional normal system will reload the WDT. The WDT never time out for a normal system. The WDT will not be reloaded by an abnormal system, then WDT will time out and reset the system automatically to avoid abnormal operation.

This board supports 255 levels watchdog timer by software programming I/O ports. Below are the source codes written in C, please take them as WDT application example.

```
/*-----*/
#include <math.h>
#include <stdio.h>
#include <dos.h>

int WDTCount;

int main(void)
{
    unsigned char          iCount;

    printf("WDT Times ( 1 ~ 255 ) : ");
    scanf("%d",&iCount);
    printf("\n");

    WDT_Start(iCount);

    return 0;
}

void WDT_Start(int iCount)
{
    outportb(0x66,0xBA);          /* Enable Watch Dog */
    delay(2000);

    WDTCount = iCount;
    outportb(0x62, WDTCount);    /* Number is Watch Dog Down count
number */
    delay(2000);

    outportb(0x62, 0x00);        /* Minute is 1 count unit by minute */
                                /* Minute is 0 count unit by second */
}
```

```
}  
  
void WDT_Stop(void)  
{  
    outportb(0x66,0xBB);           /* Disable Watch Dog */  
}  
  
void WDT_Clear(void)  
{  
    outportb(0x66,0xBA);           /* Enable Watch Dog */  
    delay(2000);  
  
    outportb(0x62, WDTCount);      /* Number is Watch Dog Down count  
number */  
    delay(2000);  
  
    outportb(0x62, 0x00);          /* Minute is 1 count unit by minute */  
                                   /* Minute is 0 count unit by second */}
```

Appendix E: DIO Sample Code

```
/*-----*/
#include "math.h"
#include "stdio.h"
#include "dos.h"

void GPIOMode(int iMode);
void GPIOData(int iData);
int GPIOStatus();

int main(void)
{
    int iInput;

    GPIOMode(0xF);
    delay(10000);

    GPIOData(0x0A);
    delay(30000);
    iInput = GPIOStatus();
    printf(" Data : %2x \n",iInput);

    GPIOData(0x05);
    delay(30000);
    iInput = GPIOStatus();
    printf(" Data : %2x \n",iInput);

    return 0;
}

void GPIOMode(int iMode)
{
    outportb(0x66,0xEB);          /* Select DIO pin to output or input */
    delay(2000);
    outportb(0x62,iMode);
}

void GPIOData(int iData)
{
    outportb(0x66,0xEA);          /* Set DIO output pin status */
    delay(2000);
    outportb(0x62,iData);
}

int GPIOStatus()
{
    int iStatus;

    outportb(0x66,0xEC);          /* Get DIO pin status */
    delay(2000);
    iStatus = inportb(0x62);

    return iStatus;
}
```