EmETXe-i92U0

**COM Express® Compact
Type 6 CPU Module**

User's Manual

Version 1.0

Revision History

Version	Date	Description
1.0	2022.07	Initial release

Preface	iii
Copyright Notice	iii
Declaration of Conformity	iii
CE.....	iii
FCC Class B.....	iii
RoHS	iv
SVHC / REACH	iv
Warning	v
Replacing the Lithium Battery.....	v
Technical Support.....	v
Warranty	vi
Chapter 1 - Introduction	1
1.1 The Product.....	2
1.2 About This Manual.....	2
1.3 Specifications	3
1.4 Inside the Package.....	4
1.5 Ordering Information.....	5
1.5.1 Optional Accessories.....	5
Chapter 2 - Board Overview	7
2.1 What Is “COM Express®”?	8
2.2 Board Dimensions	9
2.3 Block Diagram	10
2.4 Connector Pin Definition.....	11
Chapter 3 - Installation & Maintenance	15
3.1 Installing the CPU Module to Carrier Board	16
Chapter 4 - BIOS	19
4.1 Main.....	20
4.2 Advanced.....	22
4.2.1 CPU Configuration.....	23
4.2.2 Power & Performance	24
4.2.3 PCH-FW Configuration.....	25
4.2.4 Trusted Computing	26

4.2.5 ACPI Settings	27
4.2.6 Hardware Monitor	28
4.2.7 Super IO Configuration.....	29
4.2.8 S5 RTC Configuration	32
4.2.9 PCI Subsystem Settings.....	33
4.2.9.1 PCI Express Setting	34
4.2.9.2 PCI Express GEN 2 Settings.....	35
4.2.10 USB Configuration.....	36
4.2.11 Network Stack Configuration	38
4.2.12 NVMe Configuration	39
4.3 Chipset	40
4.3.1 System Agent (SA) Configuration.....	41
4.3.2 PCH-IO Configuration.....	42
4.3.2.1 PCI Express Configuration	43
4.4 Security	47
4.5 Boot	48
4.6 Save & Exit.....	49
Appendix	51
Appendix A: Watchdog Timer (WDT) Setting	52
Appendix B: DIO Sample Code	54

Copyright Notice

All Rights Reserved.

The information in this document is subject to change without prior notice in order to improve the reliability, design and function. It does not represent a commitment on the part of the manufacturer.

Under no circumstances will the manufacturer be liable for any direct, indirect, special, incidental, or consequential damages arising from the use or inability to use the product or documentation, even if advised of the possibility of such damages.

This document contains proprietary information protected by copyright. All rights are reserved. No part of this manual may be reproduced by any mechanical, electronic, or other means in any form without prior written permission of the manufacturer.

Declaration of Conformity

CE

The CE symbol on your product indicates that it is in compliance with the directives of the Union European (EU). A Certificate of Compliance is available by contacting Technical Support.

This product has passed the CE test for environmental specifications when shielded cables are used for external wiring. We recommend the use of shielded cables. This kind of cable is available from ARBOR. Please contact your local supplier for ordering information.

This product has passed the CE test for environmental specifications. Test conditions for passing included the equipment being operated within an industrial enclosure. In order to protect the product from being damaged by ESD (Electrostatic Discharge) and EMI leakage, we strongly recommend the use of CE-compliant industrial enclosure products.

Warning

This is a class A product. In a domestic environment this product may cause radio interference in which case the user may be required to take adequate measures.

FCC Class B

This device complies with Part 15 of the FCC Rules. Operation is subject to the following two conditions:

- (1) This device may not cause harmful interference, and
- (2) This device must accept any interference received, including interference that may cause undesired operation.

NOTE:

This equipment has been tested and found to comply with the limits for a Class A digital device, pursuant to Part 15 of the FCC Rules. These limits are designed to provide reasonable protection against harmful interference when the equipment is operated in a commercial environment. This equipment generates, uses, and can radiate radio frequency energy and, if not installed and used in accordance with the instruction manual, may cause harmful interference to radio communications. Operation of this equipment in a residential area is likely to cause harmful interference in which case the user will be required to correct the interference at his own expense.

RoHS

ARBOR Technology Corp. certifies that all components in its products are in compliance and conform to the European Union's Restriction of Use of Hazardous Substances in Electrical and Electronic Equipment (RoHS) Directive 2002/95/EC.

The above mentioned directive was published on 2/13/2003. The main purpose of the directive is to prohibit the use of lead, mercury, cadmium, hexavalent chromium, polybrominated biphenyls (PBB), and polybrominated diphenyl ethers (PBDE) in electrical and electronic products. Member states of the EU are to enforce by 7/1/2006.

ARBOR Technology Corp. hereby states that the listed products do not contain unintentional additions of lead, mercury, hex chrome, PBB or PBDB that exceed a maximum concentration value of 0.1% by weight or for cadmium exceed 0.01% by weight, per homogenous material. Homogenous material is defined as a substance or mixture of substances with uniform composition (such as solders, resins, plating, etc.). Lead-free solder is used for all terminations (Sn(96-96.5%), Ag(3.0-3.5%) and Cu(0.5%)).

SVHC / REACH

To minimize the environmental impact and take more responsibility to the earth we live, Arbor hereby confirms all products comply with the restriction of SVHC (Substances of Very High Concern) in (EC) 1907/2006 (REACH --Registration, Evaluation, Authorization, and Restriction of Chemicals) regulated by the European Union.

All substances listed in SVHC < 0.1 % by weight (1000 ppm)

Warning

Single Board Computers and their components contain very delicate Integrated Circuits (IC). To protect the Single Board Computer and its components against damage from static electricity, you should always follow the following precautions when handling it :

1. Disconnect your Single Board Computer from the power source when you want to work on the inside.
2. Hold the board by the edges and try not to touch the IC chips, leads or circuitry.
3. Use a grounded wrist strap when handling computer components.
4. Place components on a grounded antistatic pad or on the bag that comes with the Single Board Computer, whenever components are separated from the system.

Replacing the Lithium Battery

Incorrect replacement of the lithium battery may lead to a risk of explosion.

The lithium battery must be replaced with an identical battery or a battery type recommended by the manufacturer.

Do not throw lithium batteries into the trash-can. It must be disposed of in accordance with local regulations concerning special waste.

Technical Support

If you have any technical difficulties, please consult the user's manual first at:

<http://www.arbor-technology.com>

Please do not hesitate to call or e-mail our customer service when you still cannot find out the answer.

<http://www.arbor-technology.com>

E-mail:info@arbor.com.tw

Warranty

This product is warranted to be in good working order for a period of two years from the date of purchase. Should this product fail to be in good working order at any time during this period, we will, at our option, replace or repair it at no additional charge except as set forth in the following terms. This warranty does not apply to products damaged by misuse, modifications, accident or disaster.

Vendor assumes no liability for any damages, lost profits, lost savings or any other incidental or consequential damage resulting from the use, misuse of, or inability to use this product. Vendor will not be liable for any claim made by any other related party.

Vendors disclaim all other warranties, either expressed or implied, including but not limited to implied warranties of merchantability and fitness for a particular purpose, with respect to the hardware, the accompanying product's manual(s) and written materials, and any accompanying hardware. This limited warranty gives you specific legal rights.

Return authorization must be obtained from the vendor before returned merchandise will be accepted. Authorization can be obtained by calling or faxing the vendor and requesting a Return Merchandise Authorization (RMA) number. Returned goods should always be accompanied by a clear problem description.



Chapter 1

Introduction

1.1 The Product

The EmETXe-i92U0 is a space-conscious CPU board of 95 mm x 95 mm to take up only small footprint in your system. By the architecture of Type 6, the board has two high-performance connectors to promise stable data passing rate. The soldered onboard 6th Generation Intel® Core™ processor, along with integrated Intel® Graphics chipset, bring LVDS, and DDI solution for most monitors or LCD video panels.

For system configuration, the board is supported by AMI UEFI BIOS. EmETXe-i92U0 is an ideal choice for some demanding industrial control and data communications by its significant processing performance, low power consumption and these features:

- Soldered onboard 11th Generation Intel® Core™ i7-1185G7E/ i5-1145G7E/ i3-1115G4E/ Celeron 6305E processor
- Intel I219LM PCIe GbE PHY w/ iAMT
- Dual Channels 24-bit LVDS, Analog RGB and 3 x DDI ports
- Support 4 independent displays
- 8.5V~20V Wide Range Voltage Input
- Wide Range Operating Temp.: -40 ~ 85°C

1.2 About This Manual

This user's manual provides general information and installation instructions about the product. This user's manual is intended for experienced users and integrators with hardware knowledge of personal computers. If you are not sure about any description in this booklet. Please consult your vendor before further handling.

1.3 Specifications

System	
CPU	Soldered onboard 11th Generation Intel® Core™ - i7-1185G7E 1.8GHz(Base)/ 4.4GHz (Turbo) - i5-1145G7E 1.5GHz(Base)/ 4.1GHz (Turbo) - i3-1115G4E 2.2GHz(Base)/ 3.9GHz (Turbo) - Celeron 6305E 1.8GHz processor
Memory	2 x DDR4 SO-DIMM sockets
BIOS	AMI UEFI BIOS
Watchdog Timer	1~255 levels reset
I/O	
USB Port	12 x USB ports: - 8 x USB 2.0 ports - 4 x USB 3.2 ports
Serial Port	2 x UART ports (RX/TX only)
Expansion Bus	1 x PCIe4 lanes*, 4 x PCIe1 lanes, I ² C Interface, GPIO <small>*Note: One PCIe4 lane is from CPU, and it can not be configured as four x1 lanes.</small>
Storage	Two Serial ATA ports with 600MB/s HDD transfer rate
Ethernet Chipset	1 x Intel® i219LM PCIe GbE PHY w/ iAMT
Audio	HD audio link
TPM	Supports TPM 2.0
MIPI DSI	Supports MIPI DSI interface via on CPU module connector (OEM Request)
Display	
Graphic Chipset	Integrated Intel® Iris Xe or UHD Graphics (Depends on CPU SKU)

Graphic Interface	LCD: Dual Channels 24-bit LVDS 1 x Analog RGB port 3 x DDI ports (Max 4 independent display)
Mechanical & Environmental	
Power Requirement	8.5V ~ 20V wide range voltage input, +5VSB +/- 5% support for S3
Power Consumption	1.14A@20V 8A@8.5V (i5-1145G7E CPU Module only)
Operating Temp.	-40 ~ 85°C (-40 ~ 185°F)
Operating Humidity	10 ~ 95% @ 85°C (non-condensing)
Dimensions (L x W)	95 x 95 mm (3.7" x 3.7")

1.4 Inside the Package

Before you begin installing your single board, please make sure that the following materials have been shipped:

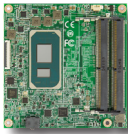

1 x EmETXe-i92U0 COM Express CPU Module



1 x Quick Installation Guide

If any of the above items is damaged or missing, contact your vendor immediately.

1.5 Ordering Information

EmETXe-i92U0-WT-1185G7E	11 th Gen. Intel® Core™ i7-1185G7E WT COME Compact Type 6 CPU module, -40 ~ 85°C
EmETXe-i92U0-WT-1145G7E	11 th Gen. Intel® Core™ i5-1145G7E WT COME Compact Type 6 CPU module, -40 ~ 85°C
EmETXe-i92U0-WT-1115G4E	11 th Gen. Intel® Core™ i3-1115G4E WT COME Compact Type 6 CPU module, -40 ~ 85°C
EmETXe-i92U0-WT-6305E	11 th Gen. Intel® Celeron 6305E WT COME Compact Type 6 CPU module, -40 ~ 85°C

1.5.1 Optional Accessories

HS-92U0-C1	Heat sink with Fan (95x95x50mm)
HS-91U0-F2-T	Heat spreader, threaded standoffs (bore hole) (95x95x11mm)
HS-91U0-F2-NT	Heat spreader, non-threaded standoffs (bore hole) (95x95x11mm)
PBE-1705-F1	COM Express® Type 6 evaluation carrier board with SIO F71869ED module in ATX form factor
CBK-03-1705-00	Cable kit 1 x SATA cable 2 x COM Flat cables

Driver Installation

To install the drivers, please visit our website at www.arbor-technology.com and download the drivers from the **Download Center**.

This page is intentionally left blank.



Chapter 2

Board Overview

2.1 What Is “COM Express®”?

With more and more demands on small and embedded industrial boards, a multi-functional COM (Computer-on-Module) surfaces as a great solution.

COM Express® supports seven pin-out types applying to Basic and Extended form factors:

Module Type 1 and 10 support single connector with two rows (220 pins).

Module Type 2, 3, 4, 5 and 6 support two connectors with four rows (440 pins).

EmETXe-i92U0 is a Type-6 module.

Difference between Standard Type 6 and EmETXe-i92U0 is listed as below:

Module Type	Standard Type 6	EmETXe-i92U0
Connectors	2	2
Connector Rows	A, B, C, D	A, B, C, D
PCIe Lanes (Max)	24	8
LAN (Max)	1	1
Serial Ports (Max)	2	2
Digital Display I/F (Max)	3	2
USB 3.0 Ports (Max)	4	4

Row AB provides pins for PCI Express, SATA, LVDS, LCD channel, LPC bus, system and power management, VGA, LAN, and power and ground interfaces.

Row CD provides SDVO and legacy PCI signals next to additional PCI Express, LAN and power and ground signals. The COM are targeted at following applications:

- Retail & Advertising
- Medical
- Test & Measurement
- Gaming & Entertainment
- Industrial & Automation
- Military & Government
- Security

2.2 Board Dimensions

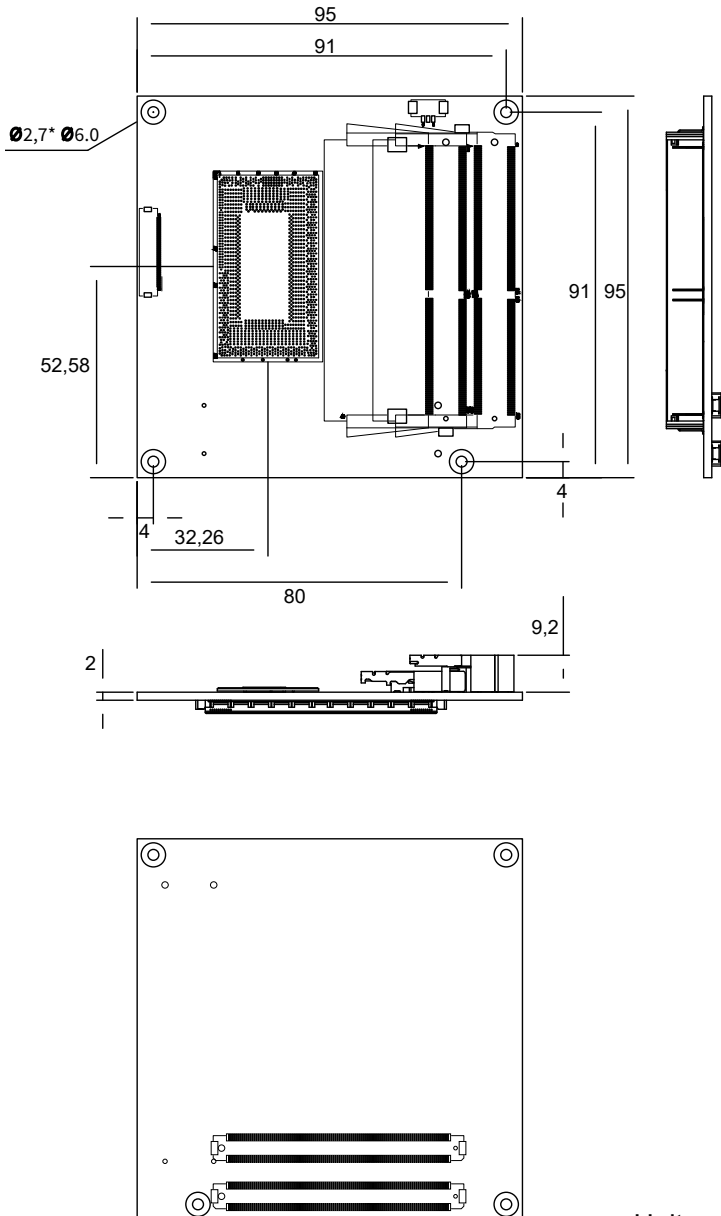

Unit: mm

2.3 Block Diagram

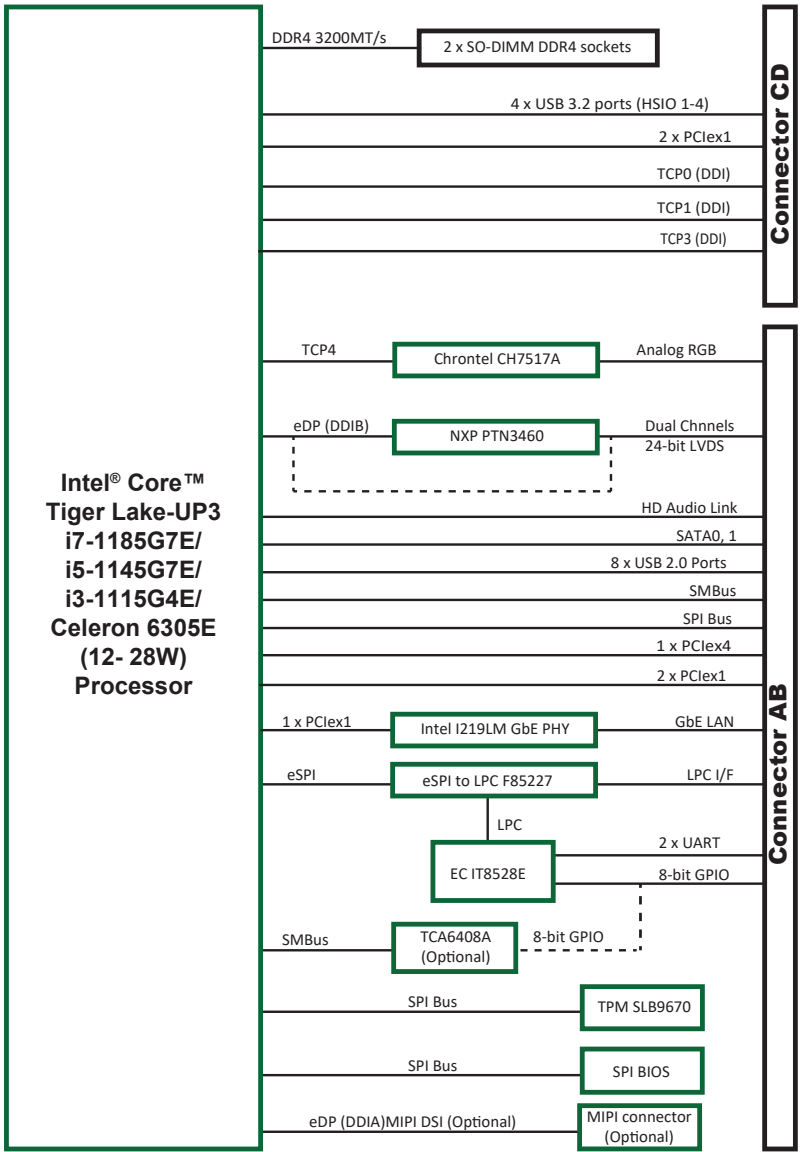

2.4 Connector Pin Definition

Being a most commonly-used Type 6, the EmETXe-i92U0 features two board-to-board connectors on bottom side.

Top Side

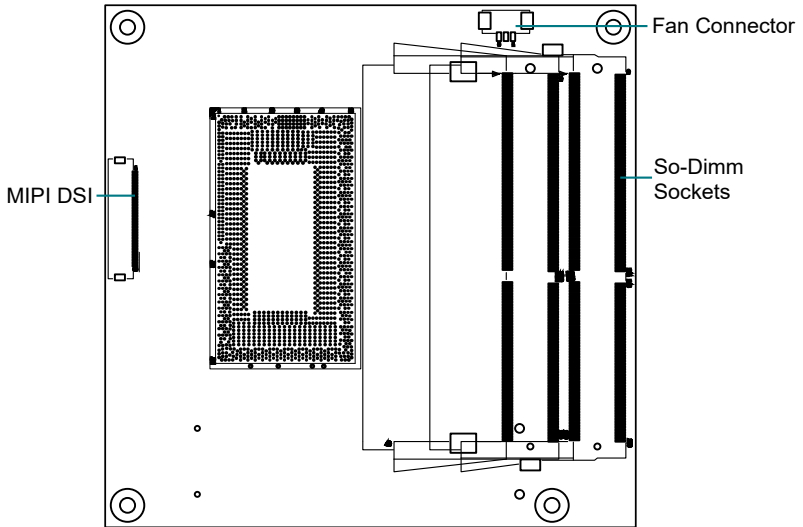

Bottom Side

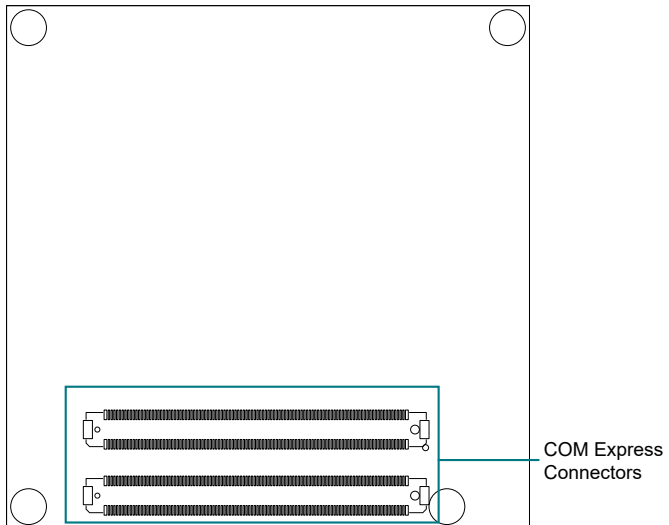

FAN1: Fan connctor

Connector type: Wafer 3-pin 1.25mm 85204-03X0L

Pin	Description
1	GND
2	Fan out
3	Fan Tachometer Input



MIPI DSI: MIPI DSI connector (by OEM request)

Connector type: Wafer 35-pin

Pin	Description	Pin	Description
1	NC1	19	GND
2	3V3-LCD	20	MIPI_TCN0
3	3V3-LCD	21	MIPI_TCP0
4	3V3-LCD	22	GND
5	LCD_RST	23	GND
6	GND	24	NC_24
7	GND	25	LEDK
8	MIPI_TDN3	26	LEDK
9	MIPI_TDP3	27	LEDK
10	GND	28	LEDK
11	MIPI_TDN2	29	LEDK
12	MIPI_TDP2	30	LEDK
13	GND	31	NC_31
14	MIPI_TDN1	32	LEDA
15	MIPI_TDP1	33	LEDA
16	GND	34	LEDA
17	MIPI_TCN	35	NC_35
18	MIPI_TCP		

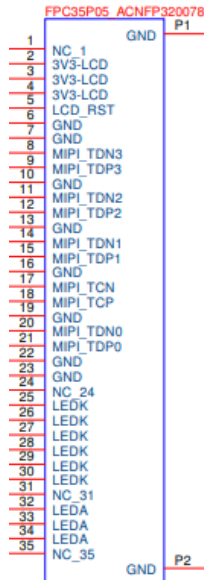

COM Express AB Connector (bottom side)

B1	GND	GND	A1	B56	PCIE_RX4-	PCIE_TX4-	A56
B2	GBE0_ACT#	GBE0_MDI3-	A2	B57	GPO2	GND	A57
B3	LPC_FRAME#	GBE0_MDI3+	A3	B58	PCIE_RX3+	PCIE_TX3+	A58
B4	LPC_AD0	GBE0_LINK100#	A4	B59	PCIE_RX3-	PCIE_TX3-	A59
B5	LPC_AD1	GBE0_LINK1000#	A5	B60	GND	GND	A60
B6	LPC_AD2	GBE0_MDI2-	A6	B61	PCIE_RX2+	PCIE_TX2+	A61
B7	LPC_AD3	GBE0_MDI2+	A7	B62	PCIE_RX2-	PCIE_TX2-	A62
B8	LPC_DRQ0#	GBE0_LINK#	A8	B63	GPO3	GP11	A63
B9	LPC_DRQ1#	GBE0_MDI1-	A9	B64	PCIE_RX1+	PCIE_TX1+	A64
B10	LPC_CLK	GBE0_MDI1+	A10	B65	PCIE_RX1-	PCIE_TX1-	A65
B11	GND	GND	A11	B66	PCIE_RX0+	GND	A66
B12	PWRBTN#	GBE0_MDI0-	A12	B67	WAKE1#	GP12	A67
B13	SMB_CK	GBE0_MDI0+	A13	B68	PCIE_RX0+	PCIE_TX0+	A68
B14	SMB_DATA	GBE0_CTREF	A14	B69	PCIE_RX0-	PCIE_TX0-	A69
B15	SMB_ALRERT#	SUS_S3#	A15	B70	GND	GND	A70
B16	ATA1_TX+	SATA0_TX+	A16	B71	LVDS_B0+	LVDS_A0+	A71
B17	SATA1_TX-	SATA0_TX-	A17	B72	LVDS_B0-	LVDS_A0-	A72
B18	SUS_STAT#	SUS_S4#	A18	B73	LVDS_B1+	LVDS_A1+	A73
B19	SATA1_RX+	SATA0_RX+	A19	B74	LVDS_B1-	LVDS_A1-	A74
B20	SATA1_RX-	SATA0_RX-	A20	B75	LVDS_B2+	LVDS_A2+	A75
B21	GND	GND	A21	B76	LVDS_B2-	LVDS_A2-	A76
B22	N/C	N/C	A22	B77	LVDS_B3+	LVDS_VDD_EN	A77
B23	N/C	N/C	A23	B78	LVDS_B3-	LVDS_A3+	A78
B24	PWR_OK	SUS_S5#	A24	B79	LVDS_BKLT_EN	LVDS_A3-	A79
B25	N/C	N/C	A25	B80	GND	GND	A80
B26	N/C	N/C	A26	B81	LVDS_B_CK+	LVDS_A_CK+	A81
B27	WDT	BATLOW#	A27	B82	LVDS_B_CK-	LVDS_A_CK-	A82
B28	N/C	ATA_ACT#	A28	B83	LVDS_BKLT_CTRL	LVDS_I2C_CK	A83
B29	AC_SDIN1	AC_SYNC	A29	B84	VCC_5V_SBY	LVDS_I2C_DAT	A84
B30	AC_SDIN0	AC_RST#	A30	B85	VCC_5V_SBY	GP13	A85
B31	GND	GND	A31	B86	VCC_5V_SBY	RSV4	A86
B32	SPKR	AC_BITCLK	A32	B87	VCC_5V_SBY	RSV3	A87
B33	I2C_CK	AC_SDOUT	A33	B88	BIOS_DIS1#	PCIE0_CK_REF+	A88
B34	I2C_DAT	BIOS_DISABLE0#	A34	B89	VGA_RED	PCIE0_CK_REF-	A89
B35	THR#	THRMTrip#	A35	B90	GND	GND	A90
B36	USB7-	USB6-	A36	B91	VGA_GRN	SPI_POWER	A91
B37	USB7+	USB6+	A37	B92	VGA_BLU	SPI_MISO	A92
B38	USB_4_5_OC#	USB_6_7_OC#	A38	B93	VGA_HSYNC	GPO0	A93
B39	USB5-	USB4-	A39	B94	VGA_VSYNC	SPI_CLK	A94
B40	USB5+	USB4+	A40	B95	VGA_I2C_CK	SPI_MOSI	A95
B41	GND	GND	A41	B96	VGA_I2C_DAT	TPM_PP	A96
B42	USB3-	USB2-	A42	B97	SPI_CS#	N/C	A97
B43	USB3+	USB2+	A43	B98	RSV2	SERR0_TX	A98
B44	USB_0_1_OC#	USB_2_3_OC#	A44	B99	RSV1	SERR0_RX	A99
B45	USB1-	USB0-	A45	B100	GND	GND	A100
B46	USB1+	USB0+	A46	B101	FAN_PWMOUT	SERR1_TX	A101
B47	EXCD1_PERST#	VCC_RTC	A47	B102	FAN_TACHIN	SERR1_RX	A102
B48	EXCD1_CPE#	EXCD0_PERST#	A48	B103	SLEEP#	LID#	A103
B49	SYS_REST#	EXCD0_CPE#	A49	B104	VCC_12V	VCC_12V	A104
B50	CB_REST#	LPC_SERIRQ	A50	B105	VCC_12V	VCC_12V	A105
B51	GND	GND	A51	B106	VCC_12V	VCC_12V	A106
B52	PCIE_RX5+	PCIE_TX5+	A52	B107	VCC_12V	VCC_12V	A107
B53	PCIE_RX5-	PCIE_TX5-	A53	B108	VCC_12V	VCC_12V	A108
B54	GPO1	GP10	A54	B109	VCC_12V	VCC_12V	A109
B55	PCIE_RX4+	PCIE_TX4+	A55	B110	GND	GND	A110

COM Express CD Connector (bottom side)

D1	GND	GND	C1	D56	N/C	N/C	C56
D2	GND	GND	C2	D57	TYPE2#	N/C	C57
D3	USB_SSTX0-	USB_SSRX0-	C3	D58	N/C	N/C	C58
D4	USB_SSTX0+	USB_SSRX0+	C4	D59	N/C	N/C	C59
D5	GND	GND	C5	D60	GND	GND	C60
D6	USB_SSTX1-	USB_SSRX1-	C6	D61	N/C	N/C	C61
D7	USB_SSTX1+	USB_SSRX1+	C7	D62	N/C	N/C	C62
D8	GND	GND	C8	D63	N/C	RSV18	C63
D9	USB_SSTX2-	USB_SSRX2-	C9	D64	N/C	RSV19	C64
D10	USB_SSTX2+	USB_SSRX2+	C10	D65	N/C	N/C	C65
D11	GND	GND	C11	D66	N/C	N/C	C66
D12	USB_SSTX3-	USB_SSRX3-	C12	D67	GND	RSV20	C67
D13	USB_SSTX3+	USB_SSRX3+	C13	D68	N/C	N/C	C68
D14	GND	GND	C14	D69	N/C	N/C	C69
D15	DDI1_CTRLCLK_AUX+	N/C	C15	D70	GND	GND	C70
D16	DDI1_CTRLCLK_AUX-	N/C	C16	D71	N/C	N/C	C71
D17	RSV10	RSV8	C17	D72	N/C	N/C	C72
D18	RSV9	RSV7	C18	D73	GND	GND	C73
D19	PCIE_TX6+	PCIE_RX6+	C19	D74	N/C	N/C	C74
D20	PCIE_TX6-	PCIE_RX6-	C20	D75	N/C	N/C	C75
D21	GND	GND	C21	D76	GND	GND	C76
D22	PCIE_TX7+	PCIE_RX7+	C22	D77	RSV17	N/C	C77
D23	PCIE_TX7-	PCIE_RX7-	C23	D78	N/C	N/C	C78
D24	RSV5	DDI_HPD	C24	D79	N/C	N/C	C79
D25	RSV6	N/C	C25	D80	GND	GND	C80
D26	DDI1_PAIR0+	N/C	C26	D81	N/C	N/C	C81
D27	DDI1_PAIR0-	RSV1	C27	D82	N/C	N/C	C82
D28	RSV3	RSV2	C28	D83	RSV25	RSV24	C83
D29	DDI1_PAIR1+	N/C	C29	D84	GND	GND	C84
D30	DDI1_PAIR1-	N/C	C30	D85	N/C	N/C	C85
D31	GND	GND	C31	D86	N/C	N/C	C86
D32	DDI_PAIR2+	DDI2_CTRLCLK_AUX+	C32	D87	GND	GND	C87
D33	DDI1_PAIR2-	DDI2_CTRLCLK_AUX-	C33	D88	N/C	N/C	C88
D34	DDI2_DDC_AUX_SEL	DDI2_DDC_AUX_SEL	C34	D89	N/C	N/C	C89
D35	RSV11	RSV12	C35	D90	GND	GND	C90
D36	DDI1_PAIR3+	DDI3_CTRLCLK_AUX+	C36	D91	N/C	N/C	C91
D37	DDI1_PAIR3-	DDI3_CTRLCLK_AUX-	C37	D92	N/C	N/C	C92
D38	RSV4	DDI3_DDC_AUX_SEL	C38	D93	GND	GND	C93
D39	DDI2_PAIR0+	DDI3_PAIR0+	C39	D94	N/C	N/C	C94
D40	DDI2_PAIR0-	DDI3_PAIR0-	C40	D95	N/C	N/C	C95
D41	GND	GND	C41	D96	GND	GND	C96
D42	DDI2_PAIR1+	DDI3_PAIR1+	C42	D97	RSV23	RSV22	C97
D43	DDI2_PAIR1-	DDI3_PAIR1-	C43	D98	N/C	N/C	C98
D44	DDI2_HPD	DDI3_HPD	C44	D99	N/C	N/C	C99
D45	RSV13	RSV14	C45	D100	GND	GND	C100
D46	DDI2_PAIR2+	DDI3_PAIR2+	C46	D101	N/C	N/C	C101
D47	DDI2_PAIR2-	DDI3_PAIR2-	C47	D102	N/C	N/C	C102
D48	RSV16	RSV15	C48	D103	GND	GND	C103
D49	DDI2_PAIR3+	DDI3_PAIR3+	C49	D104	VCC_12V	VCC_12V	C104
D50	DDI2_PAIR3-	DDI3_PAIR3-	C50	D105	VCC_12V	VCC_12V	C105
D51	GND	GND	C51	D106	VCC_12V	VCC_12V	C106
D52	N/C	N/C	C52	D107	VCC_12V	VCC_12V	C107
D53	N/C	N/C	C53	D108	VCC_12V	VCC_12V	C108
D54	PEG_LANE_RV#	N/C	C54	D109	VCC_12V	VCC_12V	C109
D55	N/C	N/C	C55	D110	GND (FIXED)	GND	C110



Chapter 3

Installation & Maintenance

3.1 Installing the CPU Module to Carrier Board

1. Mount the EmETXe-i92U0 into PBE-1705 via COM Express connectors as below; that is, COM Express AB to AB and CD to CD.

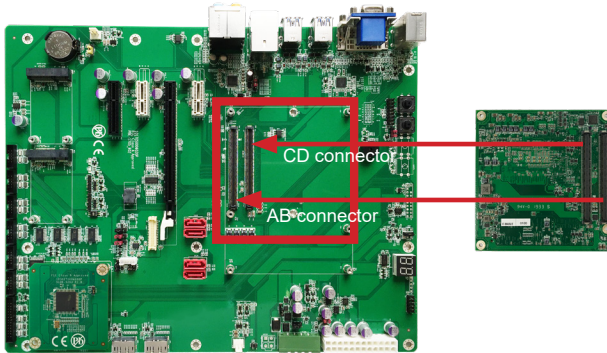

2. Install the optional heat spreader or heat sink with fan to the COM module.

For heat spreader

Apply thermal grease to the CPU area on the CPU module. Place the heat spreader over the CPU module and fasten the four screws to secure it in place.

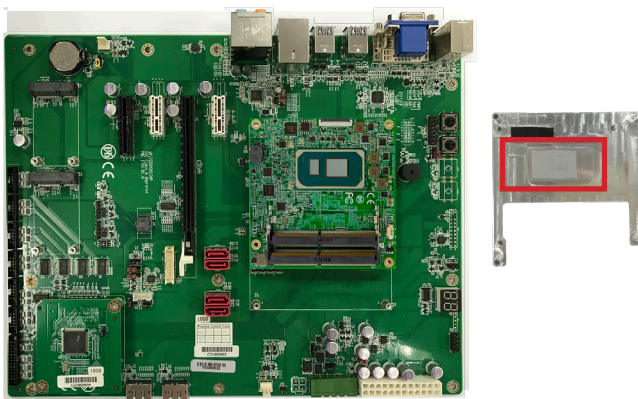

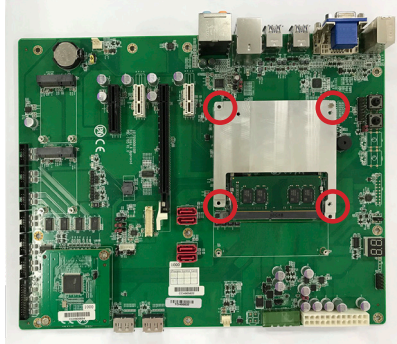

For heat sink with fan

Apply thermal grease to the CPU area on the CPU module. Place the heat sink over the CPU module and fasten the six screws to secure it in place.

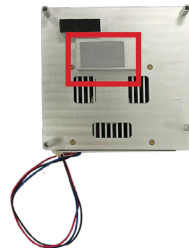
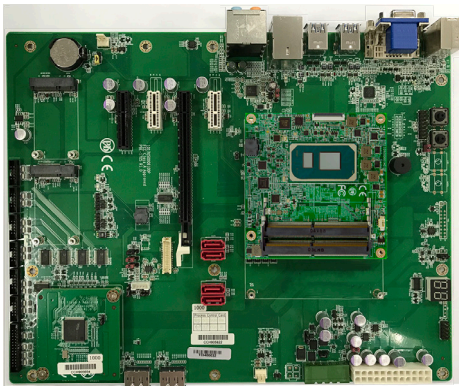

Then connect the fan cable to the fan connector on the carrier board.

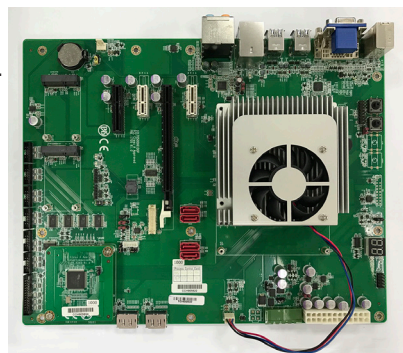

This page is intentionally left blank.



Chapter 4

BIOS

4.1 Main

The AMI BIOS provides a Setup utility program for specifying the system configurations and settings. The BIOS RAM of the system stores the Setup utility and configurations. When you turn on the computer, the AMI BIOS is immediately activated. To enter the BIOS SETUP UTILITY, press “Delete” once the power is turned on.

The **Main Setup** screen lists the following information:

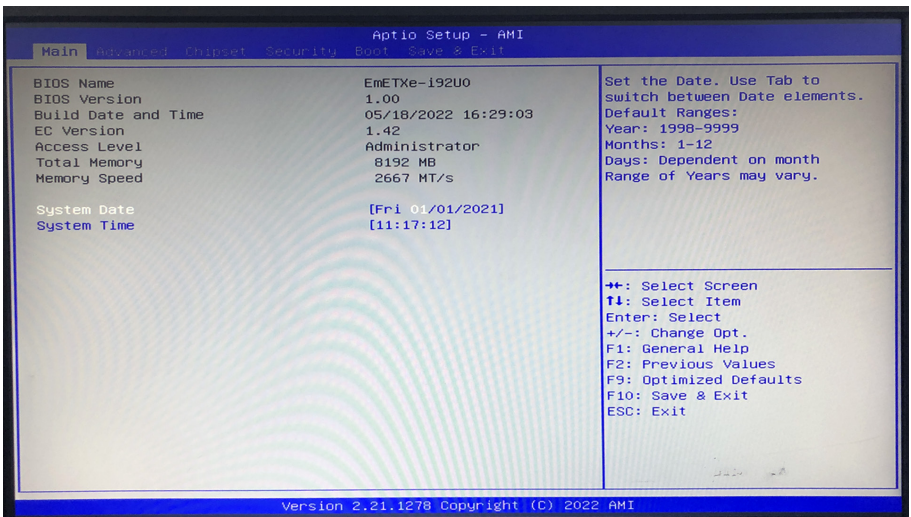

Setting	Description
System Language	Choose the system default language.
System Date	Set the system date. Use Tab to switch between Date elements. Note that the 'Day' automatically changes when you set the date. ► The date format is: Day: Sun to Sat Month: 1 to 12 Date: 1 to 31 Year: 1998 to 2099

System Time	<p>Set the system time. Use Tab to switch between Time elements.</p> <p>▶ The time format is: Hour: 00 to 23 Minute: 00 to 59 Second: 00 to 59</p>
-------------	---

Key Commands

BIOS Setup Utility is mainly a key-based navigation interface. Please refer to the following key command instructions for navigation process.

Keystroke	Function
◀ ▶	Move to highlight a particular configuration screen from the top menu bar / Move to highlight items on the screen
▼ ▲	Move to highlight previous/next item
Enter	Select and access a setup item/field
Esc	On the Main Menu – Quit the setup and not save changes into CMOS (a message screen will display and ask you to select “OK” or “Cancel” for exiting and discarding changes. Use “←” and “→” to select and press “Enter” to confirm) On the Sub Menu – Exit current page and return to main menu
Page Up / +	Increase the numeric value on a selected setup item / make change
Page Down / -	Decrease the numeric value on a selected setup item / make change
F1	Activate “General Help” screen
F10	Save the changes that have been made in the setup and exit. (a message screen will display and ask you to select “OK” or “Cancel” for exiting and saving changes. Use “←” and “→” to select and press “Enter” to confirm)

4.2 Advanced

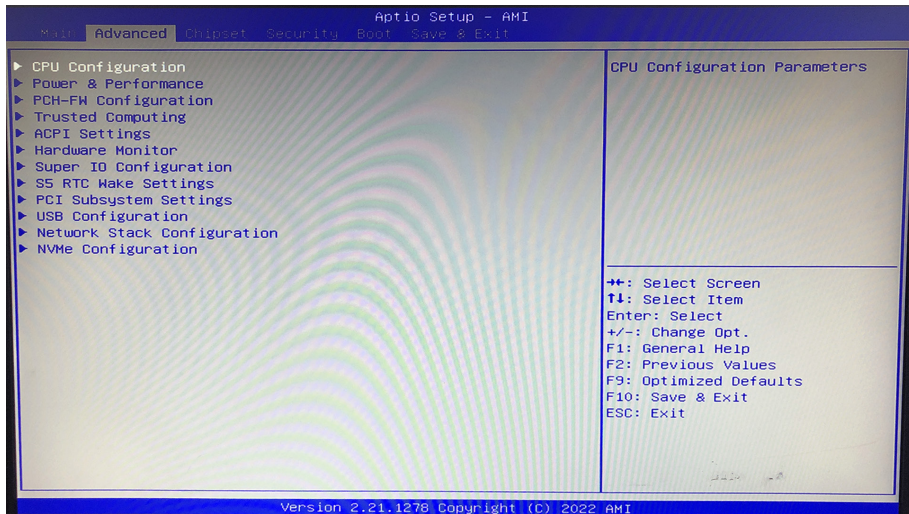

Setting	Description
CPU Configuration	See 4.2.1 CPU Configuration on page 23
Power & Performance	See 4.2.2 Power & Performance on page 24
PCH-FW Configuration	See 4.2.3 PCH-FW Configuration on page 22
Trusted Computing	See 4.2.4 Trusted Computing on page 26
ACPI Settings	See 4.2.5 ACPI Settings on page 27
Hardware Monitor	See 4.2.6 Hardware Monitor on page 28
Super IO Configuration	See 4.2.7 Super IO Configuration on page 29
S5 RTC Wake Settings	See 4.2.8 S5 RTC Configuration on page 32
PCI Subsystem Settings	See 4.2.9 PCI Subsystem Settings on page 33
USB Configuration	See 4.2.10 USB Configuration on page 36
Network Stack Configuration	See 4.2.11 Network Stack Configuration on page 38
NVMe Configuration	See 4.2.12 NVMe Configuration on page 39

4.2.1 CPU Configuration

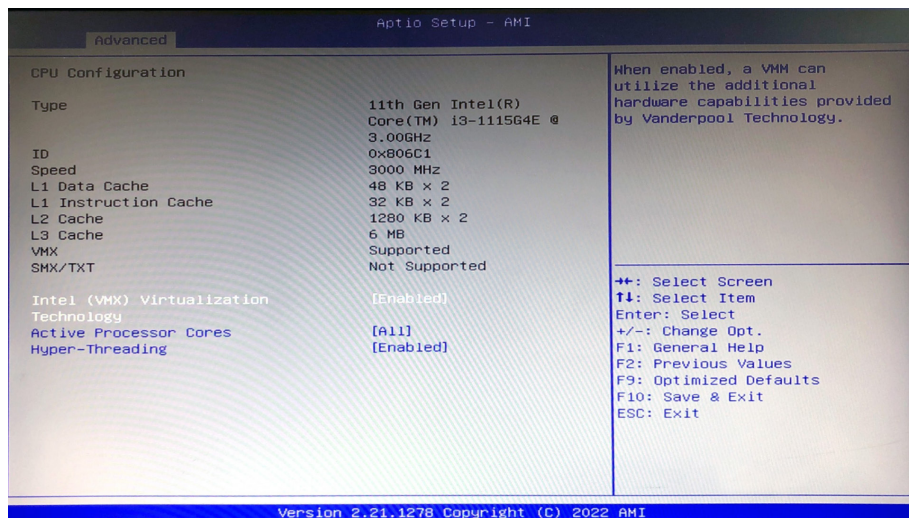

Setting	Description
Intel (VMX) Virtualization	Enable or disable Intel virtualization technology. When enabled, a VMM can utilize the additional hardware capabilities provide by Vanderpool Technology. ▶ Options: Enabled (default) or Disabled
Active Processor Cores	Number of cores to enable in each processor package. ▶ Options: All (default), 1, 2 and 3
Hyper-threading	Enabled (default) for Windows and Linux (OS optimized for Hyper-Threading Technology) and Disabled for other OS (OS not optimized or Hyper-Threading Technology). When disabled only one thread per enabled core is enabled.

4.2.2 Power & Performance

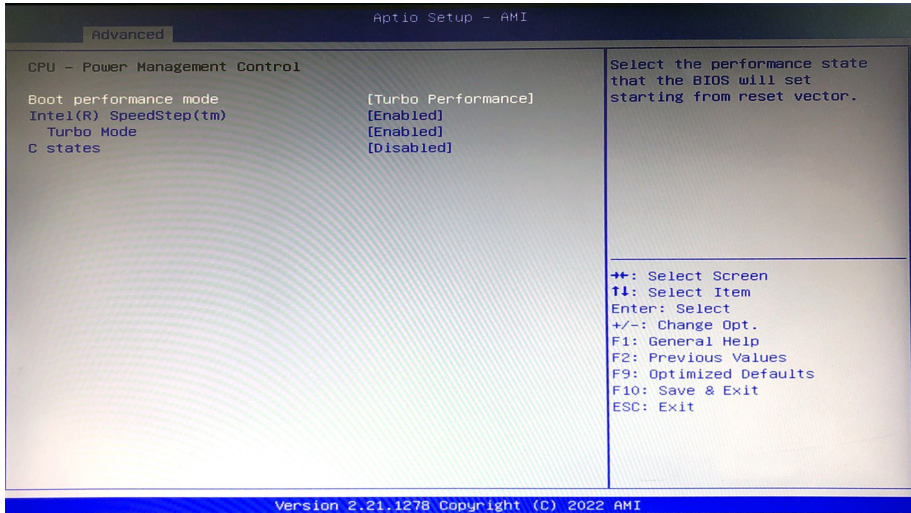

Setting	Description
Boot performance Mode	Set the performance state that the BIOS will set before the OS handoff. ► Options: Max Non-Turbo Performance , Max Power Saving and Turbo Performance (default)
Intel (R) Speed Step (tm)	Enable (default)/ Disable processor Turbo Mode (requires Intel SpeedStep or Intel Speed Shift to be available and enabled).
Turbo Mode	Enable (default)/ Disable Intel SpeedStep. Allows more than two frequency ranges to be supported.
C States	Enable /Disable (default) CPU C States

4.2.3 PCH-FW Configuration

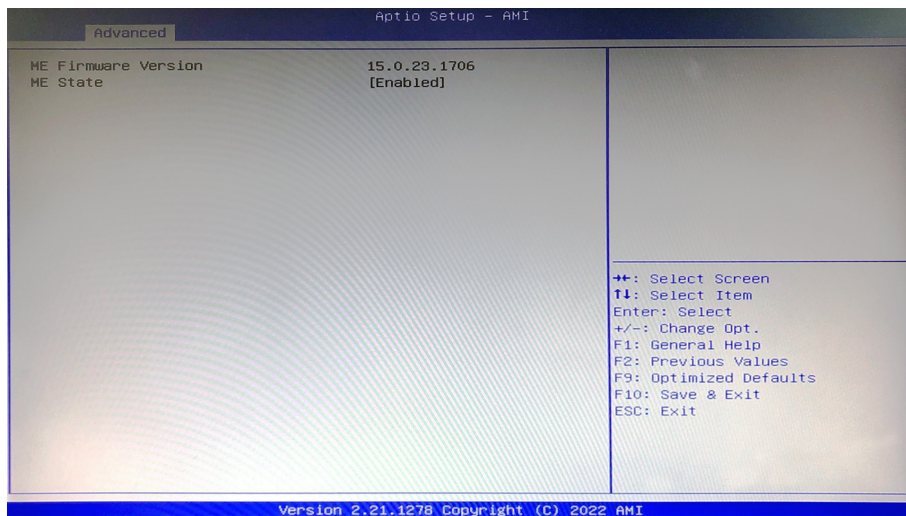

Setting	Description
ME State	Enable / Disable (Default) ME state. When disabled, ME will be put into ME Temporarily Disabled Mode.

4.2.4 Trusted Computing

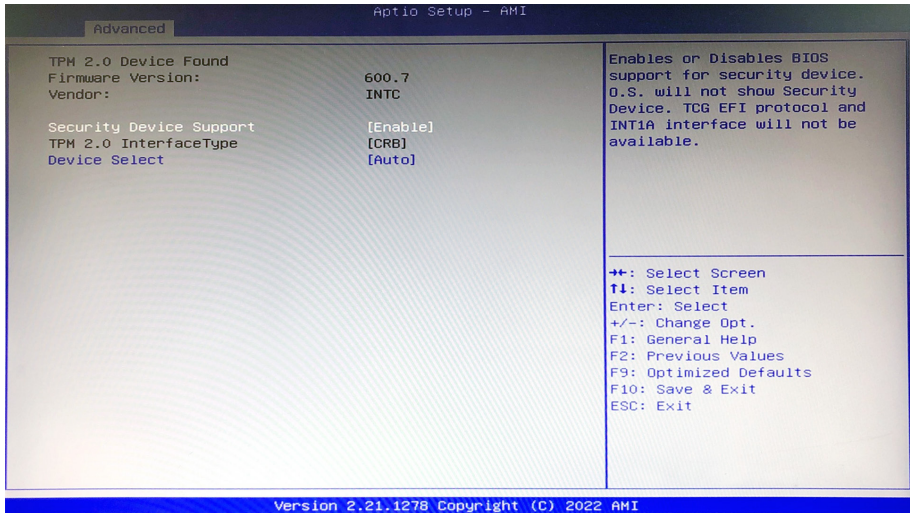

Setting	Description
Security Device Support	Enable (default) or Disable BIOS support for security device. O.S. will not show Security Device. TCG EFI protocol and INT1A interface will not be available.
Device Select	Select the TPM device: Options: TPM 1.2 , TPM 2.0 and Auto (default) <ul style="list-style-type: none"> ▶ TPM 1.2 will restrict support to TPM 1.2 devices ▶ TPM 2.0 will restrict support to TPM 2.0 devices ▶ Auto will support both with the default set to TPM 2.0 devices if not found., TPM 1.2 device will be enumerated.

4.2.5 ACPI Settings

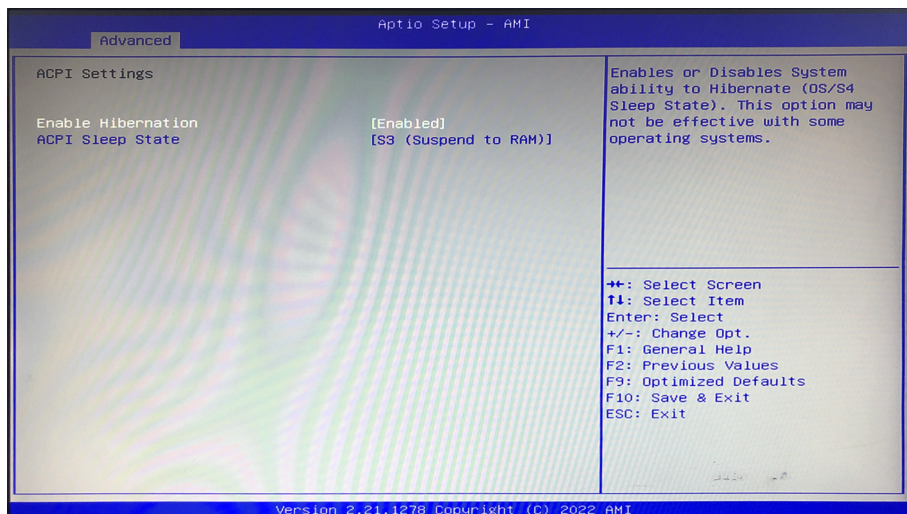

Setting	Description
Enable Hibernation	Enable (default) or Disable System ability to Hibernate (OS/S4 Sleep State). This option may be not effective with some OS.
ACPI Sleep State	Select the highest ACPI sleep state the system will enter when the SUSPEND button is pressed. <ul style="list-style-type: none"> ▶ Options: Suspend Disabled and S3 (Suspend to RAM) (default).

4.2.6 Hardware Monitor

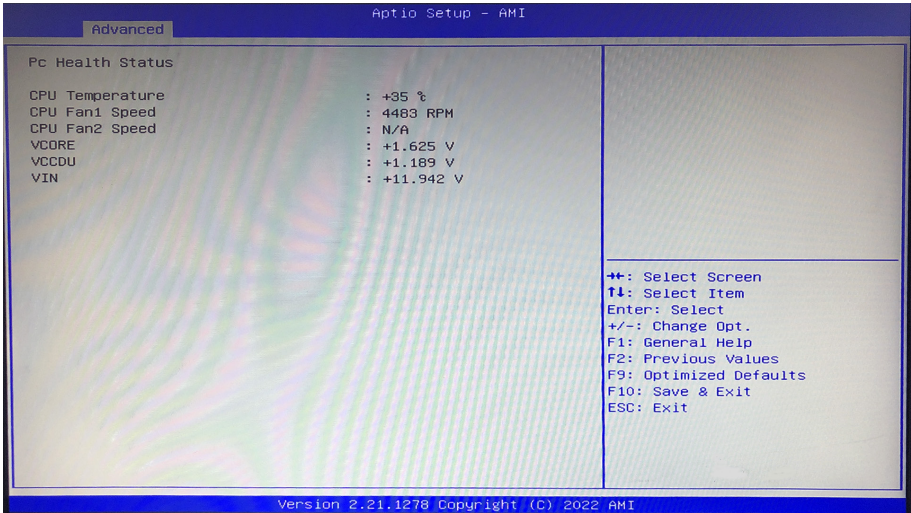

Access this submenu to monitor the hardware status.

4.2.7 Super IO Configuration

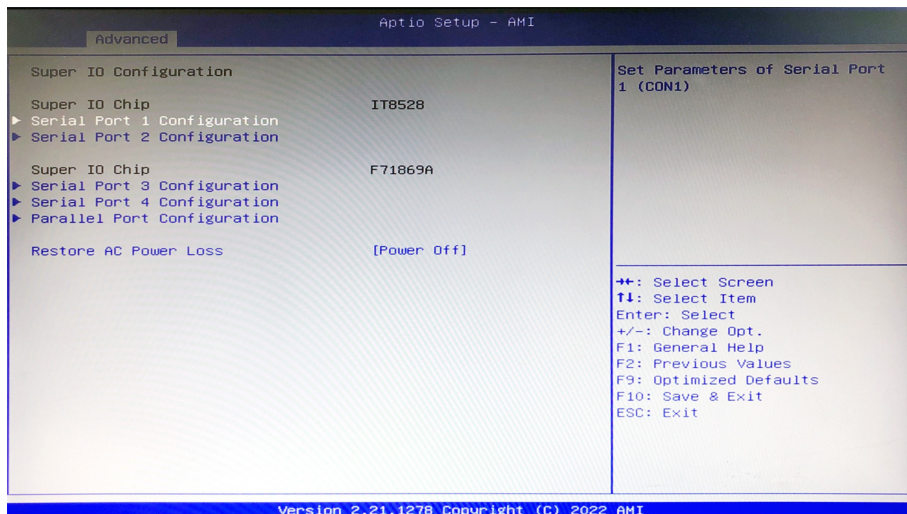

Setting	Description
Serial Port 1/2/3/4 & Parallel Port Configuration	See next page.
Restore AC Power Loss	Specify what state to go to when power is re-applied after a power failure. <ul style="list-style-type: none"> Options: Last State, Power On and Power Off (def ault)

Serial Port 1/2/3/4 Configuration

Setting	Description
Serial Port	Enable (default) or Disable Serial Port (COM).
Change Settings	<p>Select an optimal setting for Super IO device.</p> <ul style="list-style-type: none"> ▶ Options for Serial Port 1: Auto; IO=3F8h; IRQ=4 (default) ; IO=3F8h; IRQ=5, 7, 10, 11, 12 IO=2E8h; IRQ=5, 7, 10, 11, 12 ▶ Options for Serial Port 2: Auto IO=2F8h; IRQ=3 (default) IO=3F8h; IRQ=3, 4, 7, 12 IO=2F8h; IRQ=3, 4, 7, 12 ▶ Options for Serial Port 3: Auto IO=3E8h; IRQ=11 (default) IO=3E8h; IRQ=7, 10, 11, 12 IO=2E8h; IRQ=7, 10, 11, 12 IO=2F0h; IRQ=7, 10, 11, 12 IO=2E0h; IRQ=7, 10, 11, 12 ▶ Options for Serial Port 4: Auto IO=2E8h; IRQ=10 IO=3E8h; IRQ=7, 10, 11, 12 IO=2E8h; IRQ=7, 10, 11, 12 IO=2F0h; IRQ=7, 10, 11, 12 IO=2E0h; IRQ=7, 10, 11, 12

Parallel Port Configuration

Setting	Description
Parallel Port	Enable (default) or Disable Parallel Port (LPT/LPTE).
Change Settings	Select an optimal setting for Super IO device. ▶ Options: Auto IO=378h; IRQ=7 (default) IO=378h; IRQ=7, 10, 11, 12 IO=278h; IRQ=7, 10, 11, 12 IO=3BCh; IRQ=7, 10, 11, 12
Device Mode (only for Parallel Port Configuration)	Change the Printer Port mode. ▶ Options: STD Printer Mode (default) SPP Mode EPP-1.9 and SPP Mode EPP-1.7 and SPP Mode ECP Mode ECP and EPP 1.9 Mode ECP and EPP 1.7 Mode.

4.2.8 S5 RTC Configuration

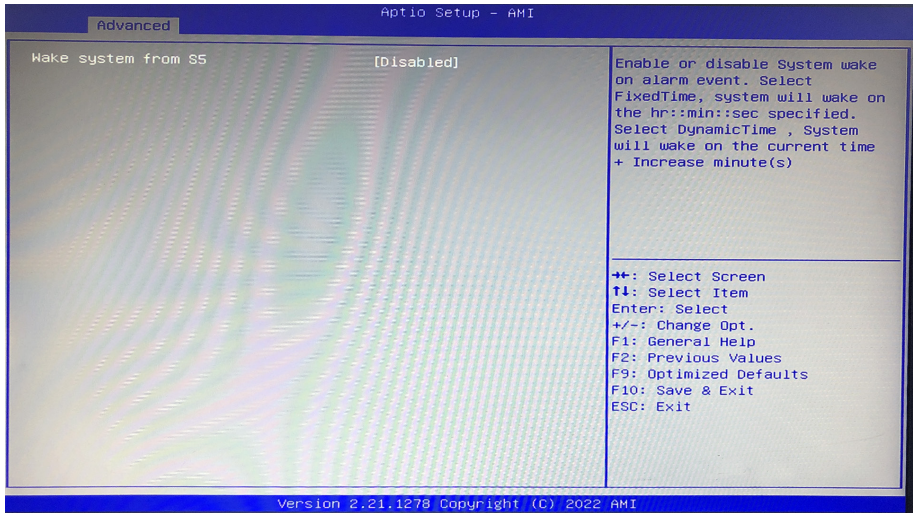

Setting	Description
Wake System from S5	<p>Enable or Disable (default) system wake on alarm event.</p> <ul style="list-style-type: none"> Options available are: <ul style="list-style-type: none"> Disabled (default): Fixed Time: System will wake on the hr::min::sec specified. DynamicTime: If selected, you need to set Wake up minute increase from 1 - 5. System will wake on the current time + increase minute(s).

4.2.9 PCI Subsystem Settings

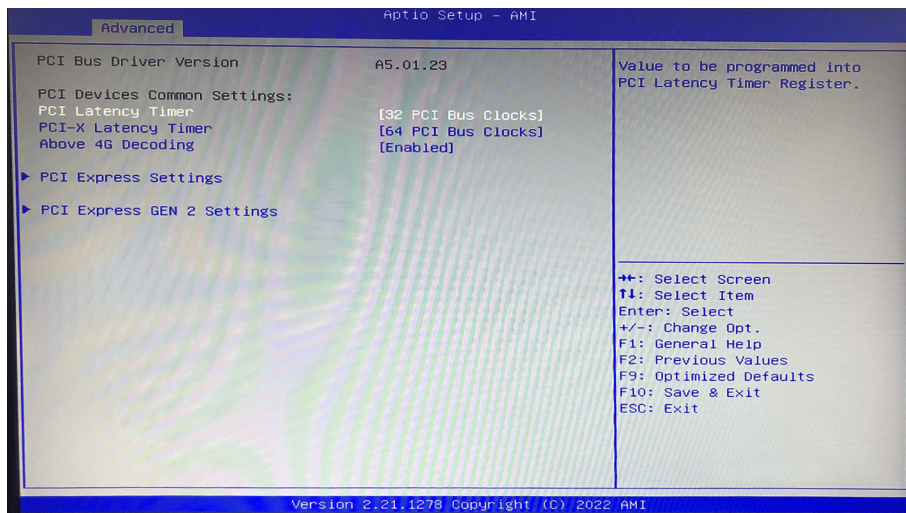

Setting	Description
PCI Latency Timer	Value to be programmed into PCI Latency timer Register. ▶ Default: 32 PCI Bus Clocks
PCI-X Latency Timer	Value to be programmed into PCI Latency timer Register. ▶ Default: 64 PCI Bus Clocks
Above 4G Decoding	Enable (default)/ Disable 64bit capable Devices to be Decoded in Above 4G Address Space (Only if System Supports 64 bit PCI Decoding).
PCI Express Setting	See next page.
PCI Express GEN2 Setting	Supports 64 bit PCI Decoding).

4.2.9.1 PCI Express Setting

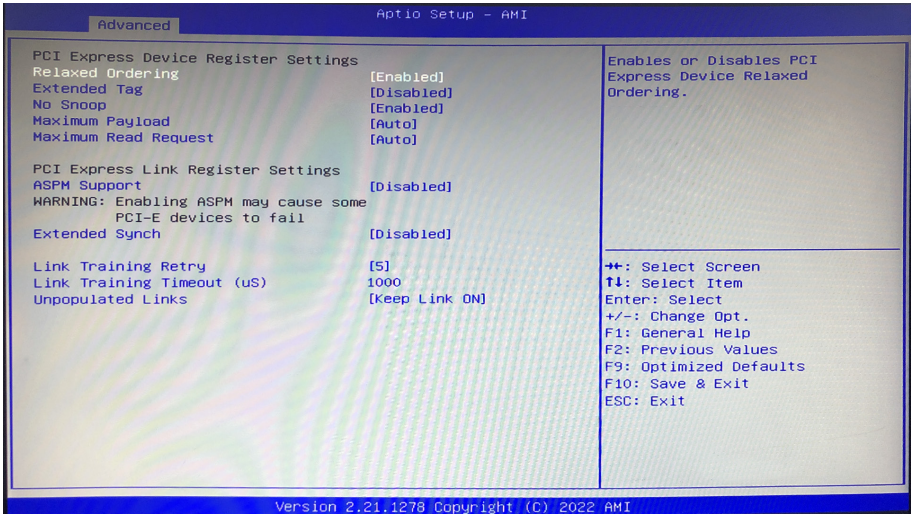

Setting	Description
Relaxed Ordering	Enable (default) or Disable Relaxed Ordering.
Extended Tag	Enable or Disable (default) Extended Tag.
No Snoop	Enable (default)/ Disable No Snoop.
Maximum Payload	This item allows users to set the Maximum Payload.
ASPM Support	Enable/Disable (default) or Auto ASPM Support.
Extended Synch	Enable or Disable (default) Extended Synch.
Link Training Retry	This item allows users to set the Link Training Retry
Training Retry Timeout	This item allows users to set the Link Training Timeout (uS)
Unpopulated Links	This item allows users to set the Unpopulated Links

4.2.9.2 PCI Express GEN 2 Settings

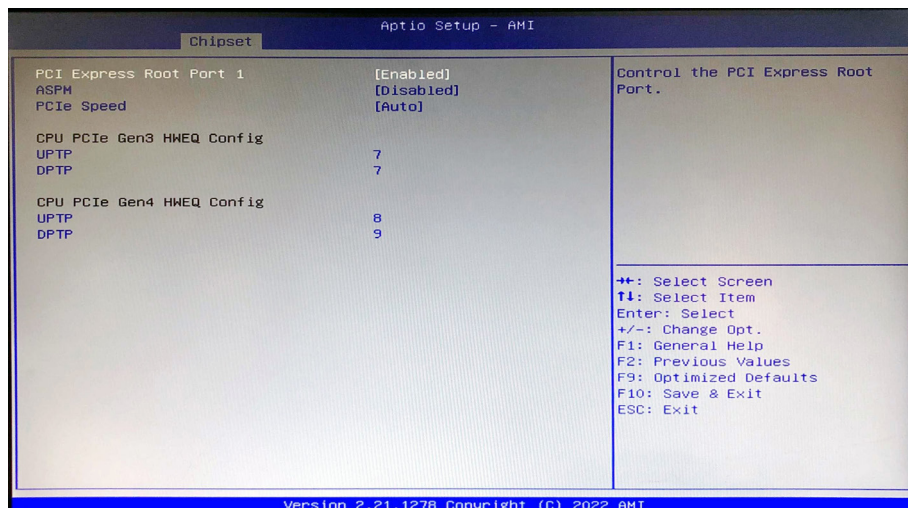

Setting	Description
PCI Express Root Port1	Control the PCI Express Root Port. Enable (default) or Disable
ASPM	PCI Express Active State Power Management settings. Enable or Disable (default) ASPM.
CPU PCIe Gen3 HWEQ Config	UPTP : Upstream Port Transmitter Preset. Values: 7 (Default) DPTP : Downstream Port Transmitter Preset. Values: 7 (Default)
CPU PCIe Gen4 HWEQ Config	UPTP : Upstream Port Transmitter Preset. Values: 8 (Default) DPTP : Downstream Port Transmitter Preset. Values: 9 (Default)

4.2.10 USB Configuration

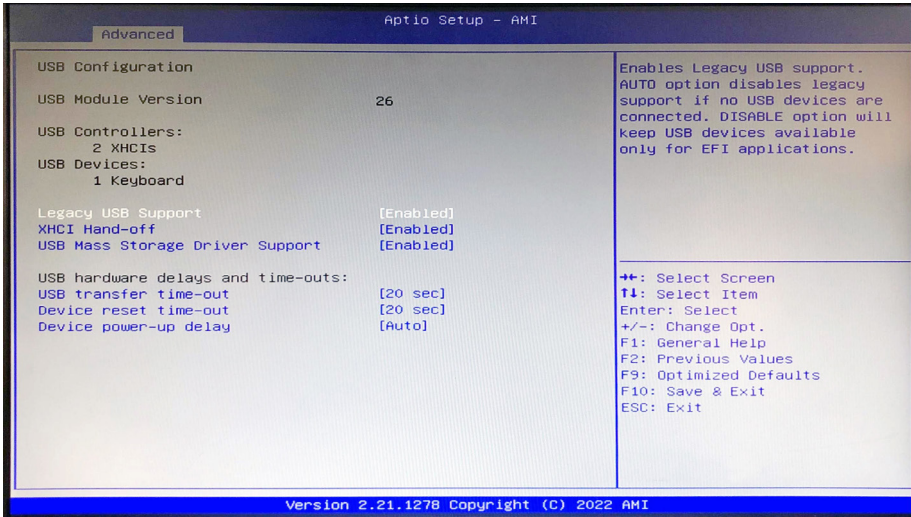

Setting	Description
Legacy USB Support	Sets legacy USB support. ▶ Options: Enabled (default), Disabled and Auto . AUTO option disables legacy support if no USB devices are connected. Disable option will keep USB devices available only for EFI applications.
XHCI Hand-off	Enable (default) or Disable XHCI Hand-off This is a workaround for Oses without XHCI hand-off support. The XHCI ownership change should be claimed by XHCI driver.
USB Mass Storage Driver Support	Enable (default) or Disable USB Mass Storage Driver Support.
USB hardware delay and time-out	
USB Transfer time-out	Use this item to set the time-out value for control, bulk, and interrupt transfers. ▶ Options available are: 1 sec , 5 sec , 10 sec , 20 sec (default)

Device reset time-out	<p>Use this item to set USB mass storage device start unit command time-out.</p> <ul style="list-style-type: none">▶ Options available are: 10 sec, 20 sec (default), 30 sec, 40 sec
Device power-up delay	<p>Use this item to set maximum time the device will take before it properly reports itself to the host controller.</p> <ul style="list-style-type: none">▶ Options available are: Auto (Default): 'Auto' uses default value: for a root port it is 100 ms, for a hub port the delay is taken from hub descriptor. Manual: Select Manual you can set value for the following sub-item: 'Device Power-up delay in seconds', the delay range in from 1 to 40 seconds, in one second increments.

4.2.11 Network Stack Configuration

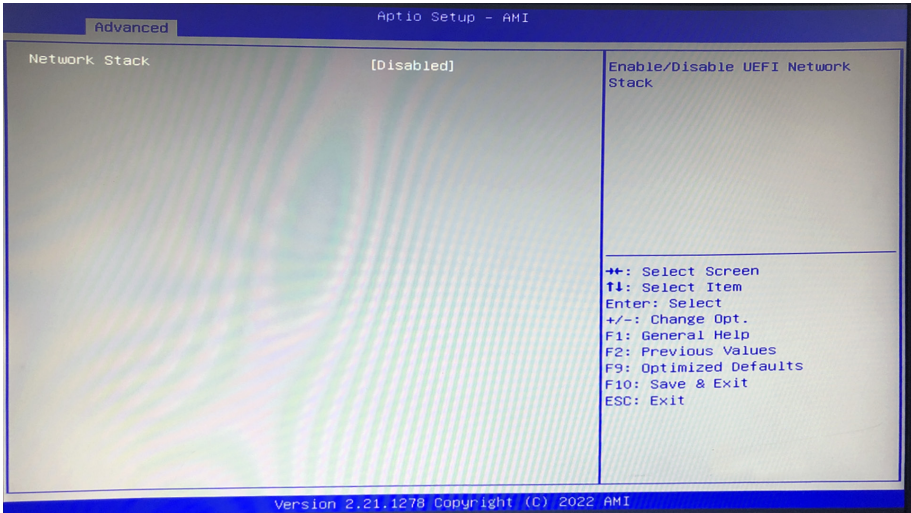

Setting	Description
Network Stack	Enables/disables UEFI network stack. ▶ Disabled is the default.

4.2.12 NVMe Configuration

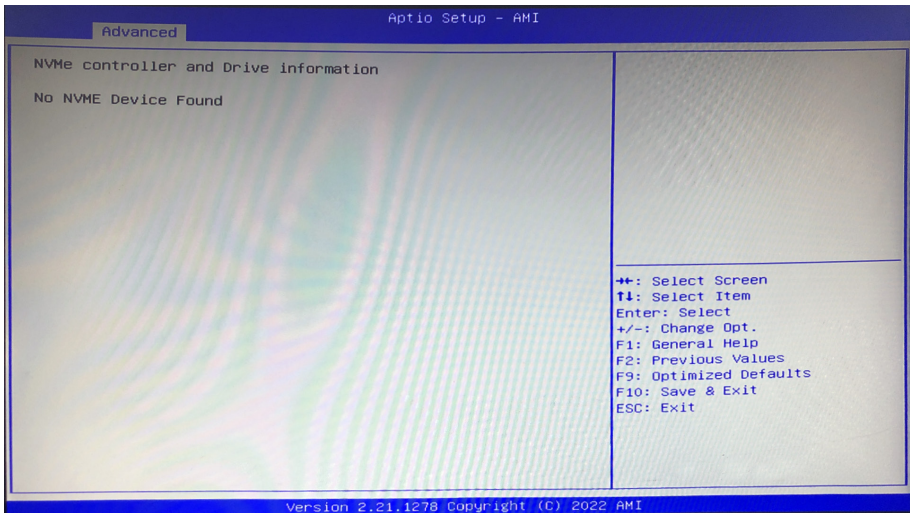

Access this submenu to view the NVMe controller and driver information.

4.3 Chipset

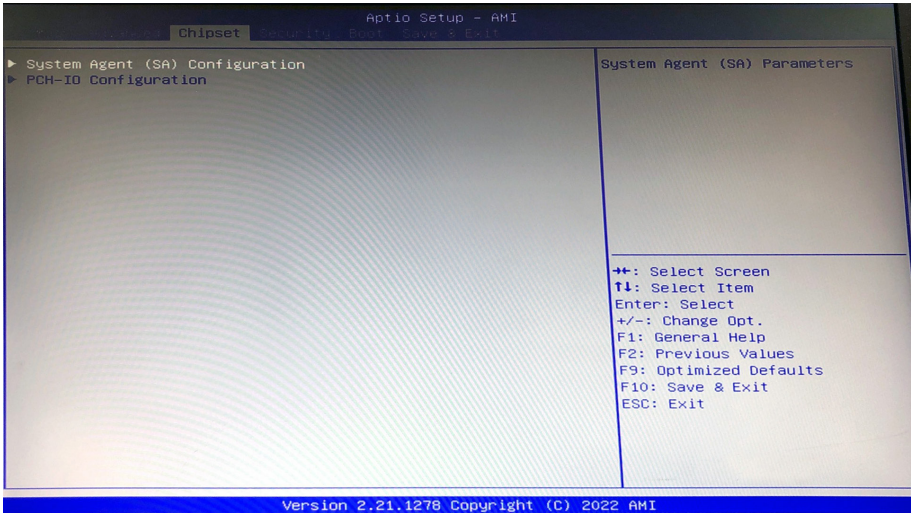

Setting	Description
System Agent (SA) Configuration	See 4.3.1 System Agent (SA) Configuration on page 43
PCH-IO Configuration	See 4.3.2 PCH-IO Configuration on page 42

4.3.1 System Agent (SA) Configuration

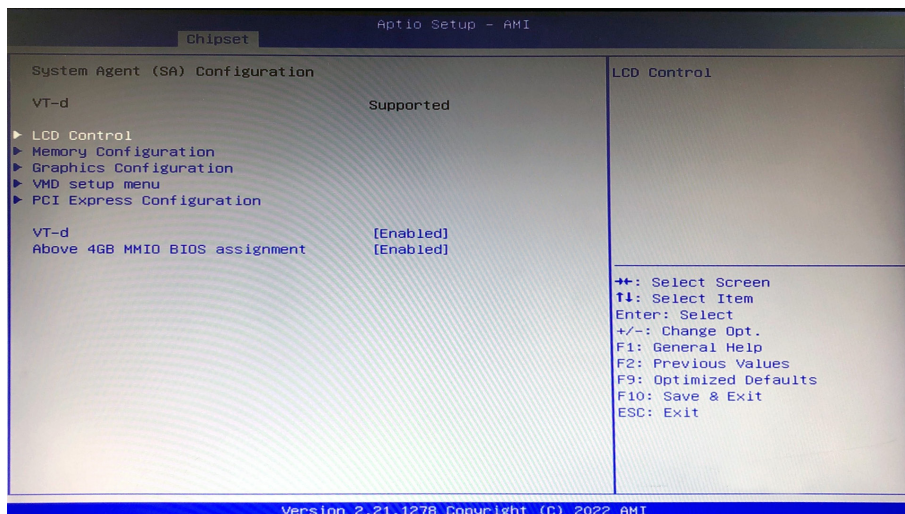

Setting	Description
VT-d	Enable (default) or Disable VT-d function
Above 4GB MMIO BIOS assignment	Enable or Disable (default) Above 4GB MmemoryMapped BIOS assignment. This is automatically enabled when Aperture Size is set to 2048MB.
LCD Control	
Primary IGFX Boot Display	Select the Video Device which will be activated during POST. This has no effect if external graphics present. Secondary boot display selection will appear based on your selection. VGA modes will be supported only on primary display. <ul style="list-style-type: none"> Options: VBIOS Default (default), LFP, EFP2, EFP and EFP3.
Active LFP	Configuring LFP usage <ul style="list-style-type: none"> Options: No eDP (default) and eDP Port-A
Memory Configuration	ENABLE (default) or Disable above 4GB MemoryMappedIO BIOS assignment.

4.3.2 PCH-IO Configuration

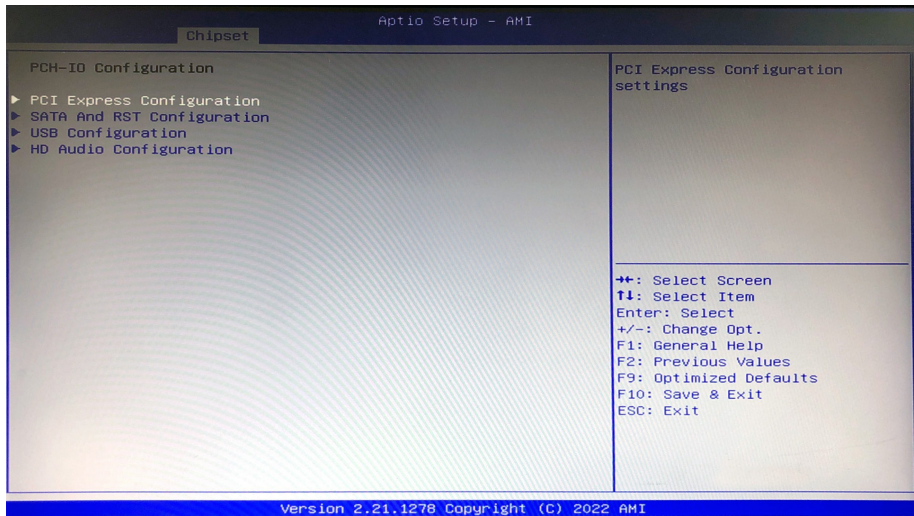

Setting	Description
PCI Express Configuration	See 4.3.2.1 PCI Express Configuration on page 43
SATA Configuration	See 4.3.2.2 SATA Configuration on page 44
USB Configuration	See 4.3.2.3 USB Configuration on page 45
HD Audio Configuration	See 4.3.2.4 HD Audio Configuration on page 46

4.3.2.1 PCI Express Configuration

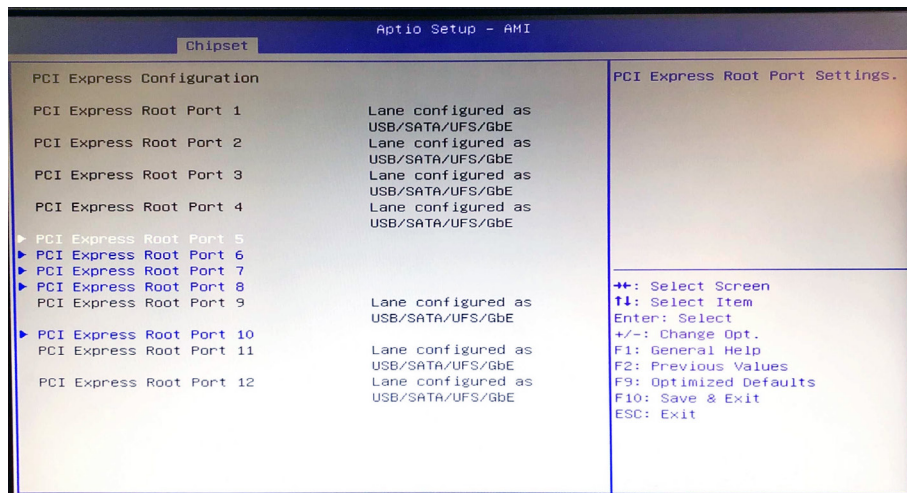

Setting	Description
PCI Express Root Port 5-11	PCI Express Root Port Settings

4.3.2.2 SATA Configuration

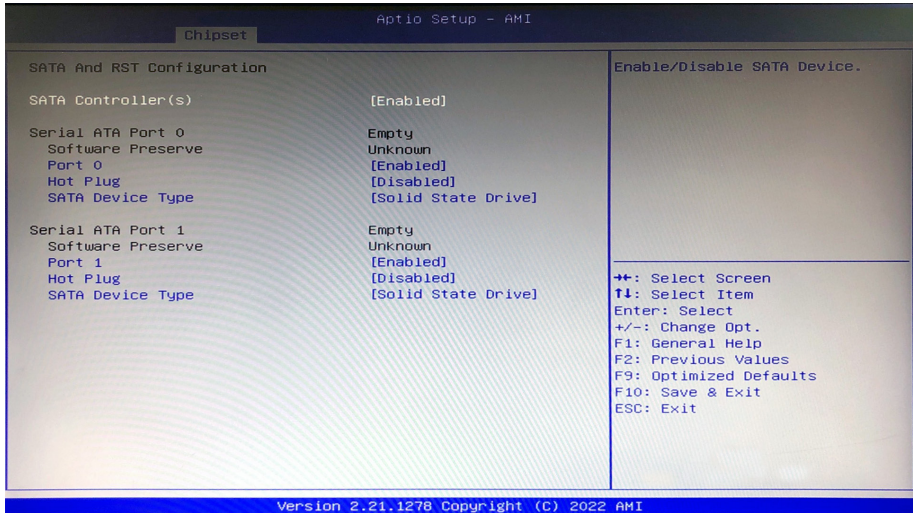

Setting	Description
SATA Controller`s)	Enable (default) or Disable SATA Device.
SATA Mode Selection	Determines how SATA controller(s) operate. ▶ Options: AHCI (default) and RAID
Port 0/1	Enable or Disable (default) SATA Port.
Hot Plug	Enable or Disable (default) the port as pluggable.
SATA Device Type	Identify the SATA port is connected to Solid State Drive or hard Disk Drive. ▶ Options: Hard Disk Drive and Solid State Drive (default).

4.3.2.3 USB Configuration

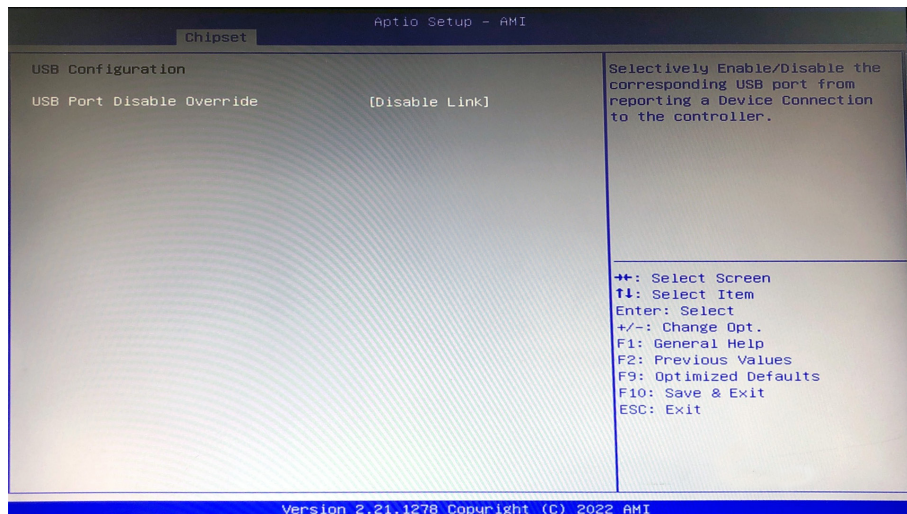

Setting	Description
USB Port Disable Override	<p>Selectively Enable/Disable (default) the corresponding USB port from reporting a Device Connection to the controller.</p> <p>► Options: Disable Link (default) and Select Per-Pin</p>

4.3.2.4 HD Audio Configuration

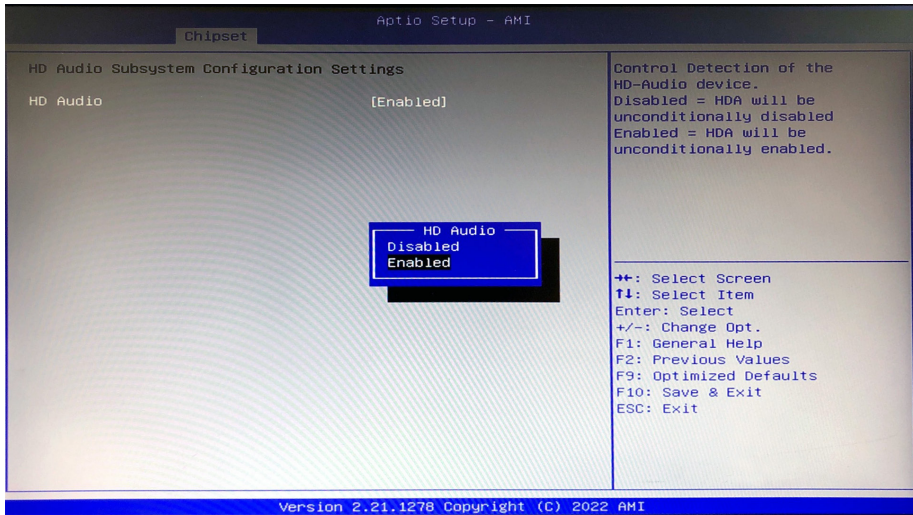

Setting	Description
HD Audio Configuration	Control Detection of the HD-Audio device. <ul style="list-style-type: none"> Options available are: <ul style="list-style-type: none"> Disabled: HDA will be unconditionally disabled Enabled (default): HDA will be unconditionally Enabled

4.4 Security

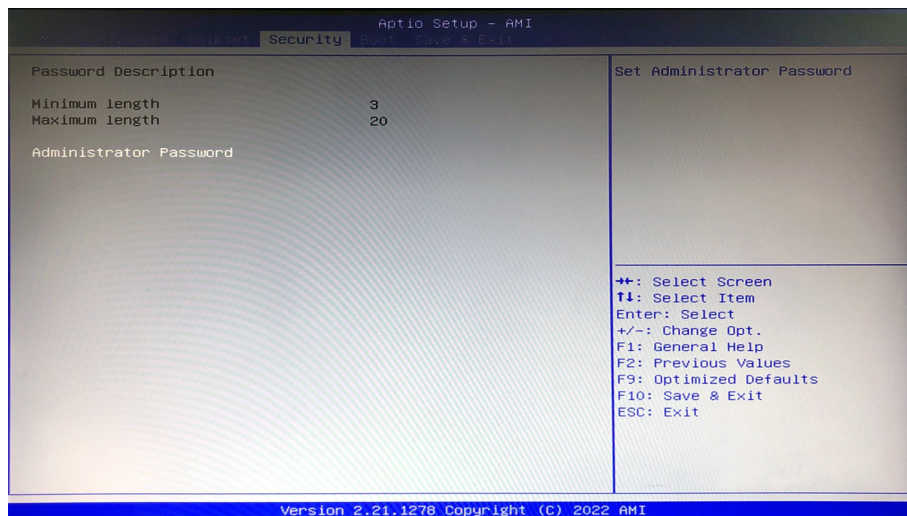

Setting	Description
Administrator Password	<p>To set up an administrator password:</p> <ol style="list-style-type: none"> 1. Select Administrator Password. The screen then pops up an Create New Password dialog. 2. Enter your desired password that is no less than 3 characters and no more than 20 characters. 3. Hit [Enter] key to submit.

4.5 Boot

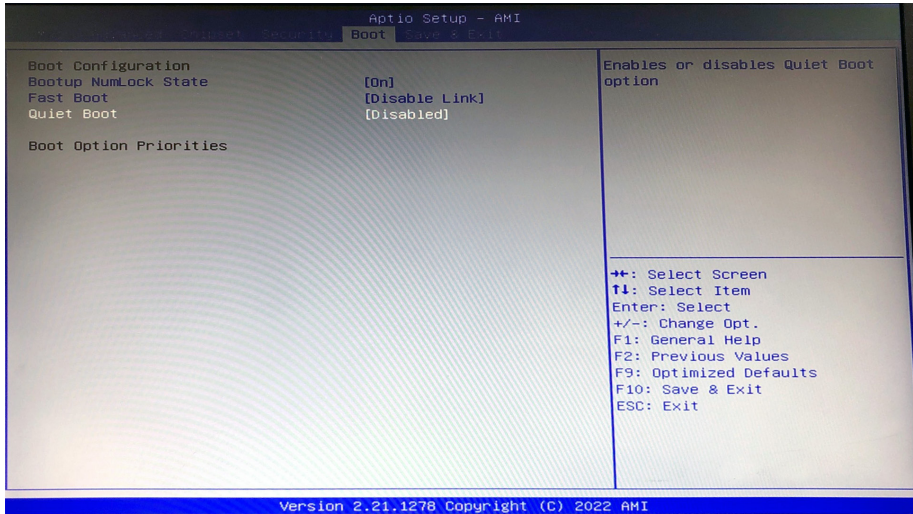

Setting	Description
Boot NumLock State	Select the keyboard NumLock state. ► Options: On (default) and Off .
Fast Boot	Enable or Disable (default) boot with initialization of a minimal set of devices required to launch active boot option. Has no effect for BBS boot options.
Quiet Boot	Enable (default) or Disable Quiet Boot option.
Boot Option Priority	Set the system boot priorities.
Hard Drive BBS Priorities	BBS means “BIOS Boot Specification”. Sets the order of the legacy devices in this group.

4.6 Save & Exit

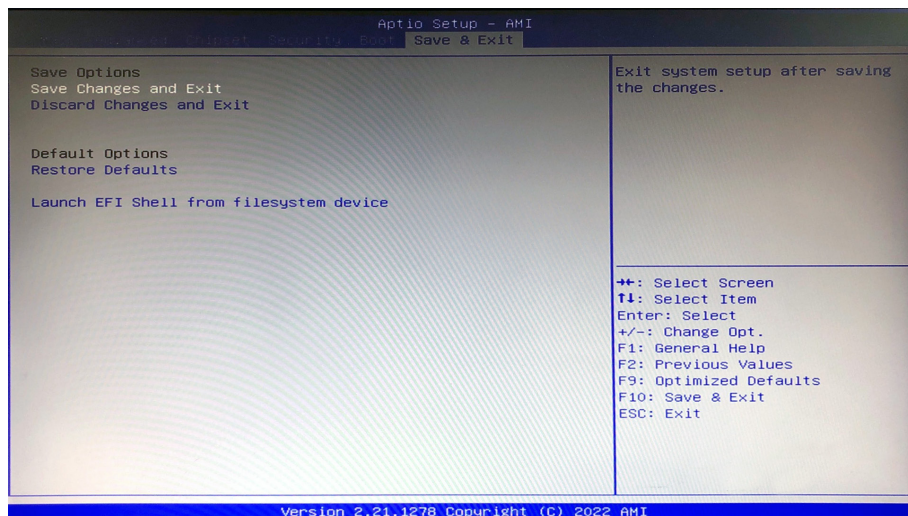

Setting	Description
Save Changes and Exit	Exit system setup after saving the changes. ▶ Enter the item and then a dialog box pops up: Save configuration and exit? (Yes/ No)
Discard Changes and Exit	Exit system setup without saving the changes. ▶ Enter the item and then a dialog box pops up: Quit without saving? (Yes/ No)
Restore Defaults	Restore/Load Default values for all the setup options. ▶ Enter the item and then a dialog box pops up: Load Optimized Defaults? (Yes/ No)
Launch EFI Shell from filesystem device	Attempts to launch EFI shell application (Shell.efi) from one of the available filesystem devices.

This page is intentionally left blank.



Appendix

Appendix A: Watchdog Timer (WDT) Setting

WDT is widely used for industry application to monitor the activity of CPU. Application software depends on its requirement to trigger WDT with adequate timer setting. Before WDT time out, the functional normal system will reload the WDT. The WDT never time out for a normal system. The WDT will not be reloaded by an abnormal system, then WDT will time out and reset the system automatically to avoid abnormal operation.

This board supports 255 levels watchdog timer by software programming I/O ports. Below are the source codes written in C, please take them as WDT application example.

```
/*-----*/
#include <math.h>
#include <stdio.h>
#include <dos.h>

int WDTCount;

int main(void)
{
    unsigned char                iCount;

    printf("WDT Times ( 1 ~ 255 ) : ");
    scanf("%d",&iCount);
    printf("\n");

    WDT_Start(iCount);

    return 0;
}

void WDT_Start(int iCount)
{
    outportb(0x66,0xBA);                /* Enable Watch Dog */
    delay(2000);

    WDTCount = iCount;
    outportb(0x62, WDTCount);          /* Number is Watch Dog Down count
number */
    delay(2000);

    outportb(0x62, 0x00);                /* Minute is 1 count unit by minute */
                                        /* Minute is 0 count unit by second */
}
```



```
}  
  
void WDT_Stop(void)  
{  
    outportb(0x66,0xBB);           /* Disable Watch Dog */  
}  
  
void WDT_Clear(void)  
{  
    outportb(0x66,0xBA);           /* Enable Watch Dog */  
    delay(2000);  
  
    outportb(0x62, WDTCount);      /* Number is Watch Dog Down count  
number */  
    delay(2000);  
  
    outportb(0x62, 0x00);          /* Minute is 1 count unit by minute */  
                                   /* Minute is 0 count unit by second */}
```

Appendix B: DIO Sample Code

```
/*-----*/
#include "math.h"
#include "stdio.h"
#include "dos.h"

void GPIOMode(int iMode);
void GPIOData(int iData);
int GPIOStatus();

int main(void)
{
    int iInput;

    GPIOMode(0xF);
    delay(10000);

    GPIOData(0x0A);
    delay(30000);
    iInput = GPIOStatus();
    printf(" Data : %2x \n", iInput);

    GPIOData(0x05);
    delay(30000);
    iInput = GPIOStatus();
    printf(" Data : %2x \n", iInput);

    return 0;
}

void GPIOMode(int iMode)
{
    outportb(0x66, 0xEB);          /* Select DIO pin to output or input */
    delay(2000);
    outportb(0x62, iMode);
}

void GPIOData(int iData)
{
    outportb(0x66, 0xEA);        /* Set DIO output pin status */
    delay(2000);
    outportb(0x62, iData);
}

int GPIOStatus()
{
    int iStatus;

    outportb(0x66, 0xEC);        /* Get DIO pin status */
    delay(2000);
    iStatus = inportb(0x62);

    return iStatus;
}
```