ASLAN-W9XXC/917X

**Fanless Industrial Panel PC with Intel® Core
i5-6300U 2.4GHz Processor**

User's Manual

Version 1.0

Revision History

Version	Date	Description
1.0	2017.09	Initial release

Revision History	ii
Contents	i
Preface.....	iii
Copyright Notice	iii
Declaration of Conformity	iii
CE.....	iii
FCC Class A	iii
RoHS	iv
SVHC / REACH	iv
Important Safety Instructions	v
Warning.....	vi
Lithium Battery Replacement.....	vi
Technical Support	vi
Warranty.....	vii
Chapter 1 - Introduction.....	1
1.1. The Computer	2
1.2. About this Manual	2
1.3. Specifications.....	3
1.4. Inside the Package	5
1.5. Ordering Information	5
Chapter 2 - Getting Started.....	7
2.1. Dimensions	8
2.2. Tour the Computer	11
2.2.1. Front View.....	11
2.2.2. Top/Bottom View	11
2.3. Driver Installation Note.....	13
Chapter 3 - Engine of the Computer.....	15
3.1. Board Layout.....	16
3.2. Jumpers and Connectors.....	19
3.2.1 Main Board (FMB-i89U1).....	19
3.2.1.1. Jumpers	19
3.2.1.1. Connectors	24
3.2.2 Daughter Board (SCB-1299H).....	48
Chapter 4 - Installation and Maintenance.....	57
4.1. Disassembly the Computer.....	58
4.1.1 ASLAN-W910C/912C	58
4.1.2. ASLAN-917X/W915C/919C/922C	60
4.2. Install Hardware	61
4.2.1. Install Wi-Fi Module	61

- 4.2.1. Install mSATA Module 67
- 4.2.1. Install SSD or HDD 69
- 4.3. Mount the Computer 71
 - 4.3.1. Panel Mounting 71
 - 4.3.2. VESA Mounting 74
- Chapter 5 - BIOS 75**
 - 5.1. Main 78
 - 5.2. Advanced 79
 - 5.2.1. CPU Configuration 80
 - 5.2.2. PCI Sybssystem Settings 81
 - 5.2.3. ACPI Settings 82
 - 5.2.4. AMT Configuration 83
 - 5.2.5. F71869A Super IO Configuration 84
 - 5.2.6. Hardware Monitor 85
 - 5.2.7. F81216SEC Super IO Configuration 86
 - 5.2.8. S5 RTC Wake Settings 87
 - 5.2.9. SATA Configuration 88
 - 5.2.10. CSM Configuration 89
 - 5.2.11. USB Configuration 90
 - 5.3. Chipset 92
 - 5.3.1. System Agent (SA) Configuration 93
 - 5.3.2. PCH-IO Configuration 96
 - 5.4 Security 99
 - 5.5. Boot 100
 - 5.6. Save & Exit 101

Copyright Notice

All Rights Reserved.

The information in this document is subject to change without prior notice in order to improve the reliability, design and function. It does not represent a commitment on the part of the manufacturer.

Under no circumstances will the manufacturer be liable for any direct, indirect, special, incidental, or consequential damages arising from the use or inability to use the product or documentation, even if advised of the possibility of such damages.

This document contains proprietary information protected by copyright. All rights are reserved. No part of this document may be reproduced by any mechanical, electronic, or other means in any form without prior written permission of the manufacturer.

Declaration of Conformity

CE

The CE symbol on your product indicates that it is in compliance with the directives of the Union European (EU). A Certificate of Compliance is available by contacting Technical Support.

This product has passed the CE test for environmental specifications when shielded cables are used for external wiring. We recommend the use of shielded cables. This kind of cable is available from ARBOR. Please contact your local supplier for ordering information.

Warning

This is a class A product. In a domestic environment this product may cause radio interference in which case the user may be required to take adequate measures.

FCC Class A

This device complies with Part 15 of the FCC Rules. Operation is subject to the following two conditions:

- (1) This device may not cause harmful interference, and
- (2) This device must accept any interference received, including interference that may cause undesired operation.

NOTE:

This equipment has been tested and found to comply with the limits for a Class A digital device, pursuant to Part 15 of the FCC Rules. These limits are designed to provide reasonable protection against harmful interference when the equipment is operated in a commercial environment. This equipment generates, uses, and can radiate radio frequency energy and, if not installed and used in accordance with the instruction manual, may cause harmful interference to radio communications. Operation of this equipment in a residential area is likely to cause harmful interference in which case the user will be required to correct the interference at his own expense.

RoHS

ARBOR Technology Corp. certifies that all components in its products are in compliance and conform to the European Union's Restriction of Use of Hazardous Substances in Electrical and Electronic Equipment (RoHS) Directive 2002/95/EC.

The above mentioned directive was published on 2/13/2003. The main purpose of the directive is to prohibit the use of lead, mercury, cadmium, hexavalent chromium, polybrominated biphenyls (PBB), and polybrominated diphenyl ethers (PBDE) in electrical and electronic products. Member states of the EU are to enforce by 7/1/2006.

ARBOR Technology Corp. hereby states that the listed products do not contain unintentional additions of lead, mercury, hex chrome, PBB or PBDB that exceed a maximum concentration value of 0.1% by weight or for cadmium exceed 0.01% by weight, per homogenous material. Homogenous material is defined as a substance or mixture of substances with uniform composition (such as solders, resins, plating, etc.). Lead-free solder is used for all terminations (Sn(96-96.5%), Ag(3.0-3.5%) and Cu(0.5%)).

SVHC / REACH

To minimize the environmental impact and take more responsibility to the earth we live, Arbor hereby confirms all products comply with the restriction of SVHC (Substances of Very High Concern) in (EC) 1907/2006 (REACH --Registration, Evaluation, Authorization, and Restriction of Chemicals) regulated by the European Union.

All substances listed in SVHC < 0.1 % by weight (1000 ppm)

Important Safety Instructions

Read these safety instructions carefully

1. Read all cautions and warnings on the equipment.
2. Place this equipment on a reliable surface when installing. Dropping it or letting it fall may cause damage
3. Make sure the correct voltage is connected to the equipment.
4. For pluggable equipment, the socket outlet should be near the equipment and should be easily accessible.
5. Keep this equipment away from humidity.
6. The openings on the enclosure are for air convection and protect the equipment from overheating. **DO NOT COVER THE OPENINGS.**
7. Position the power cord so that people cannot step on it. Do not place anything over the power cord.
8. Never pour any liquid into opening. This may cause fire or electrical shock.
9. Never open the equipment. For safety reasons, the equipment should be opened only by qualified service personnel.
10. If one of the following situations arises, get the equipment checked by service personnel:
 - a. The power cord or plug is damaged.
 - b. Liquid has penetrated into the equipment.
 - c. The equipment has been exposed to moisture.
 - d. The equipment does not work well, or you cannot get it to work according to the user's manual.
 - e. The equipment has been dropped or damaged.
 - f. The equipment has obvious signs of breakage.
11. Keep this User's Manual for later reference.

Warning

The Box PC and its components contain very delicately Integrated Circuits (IC). To protect the Box PC and its components against damage caused by static electricity, you should always follow the precautions below when handling it:

1. Disconnect your Box PC from the power source when you want to work on the inside.
2. Use a grounded wrist strap when handling computer components.
3. Place components on a grounded antistatic pad or on the bag that came with the Box PC, whenever components are separated from the system.

Lithium Battery Replacement

Incorrect replacement of the lithium battery may lead to a risk of explosion.

The lithium battery must be replaced with an identical battery or a battery type recommended by the manufacturer.

Do not throw lithium batteries into the trash can. It must be disposed of in accordance with local regulations concerning special waste.

Technical Support

If you have any technical difficulties, please consult the user's manual first at:
<http://www.arbor.com.tw>

Please do not hesitate to call or e-mail our customer service when you still cannot find out the answer.

<http://www.arbor-technology.com>

E-mail:info@arbor.com.tw

Warranty

This product is warranted to be in good working order for a period of one year from the date of purchase. Should this product fail to be in good working order at any time during this period, we will, at our option, replace or repair it at no additional charge except as set forth in the following terms. This warranty does not apply to products damaged by misuse, modifications, accident or disaster.

Vendor assumes no liability for any damages, lost profits, lost savings or any other incidental or consequential damage resulting from the use, misuse of, or inability to use this product. Vendor will not be liable for any claim made by any other related party.

Vendors disclaim all other warranties, either expressed or implied, including but not limited to implied warranties of merchantability and fitness for a particular purpose, with respect to the hardware, the accompanying product's manual(s) and written materials, and any accompanying hardware. This limited warranty gives you specific legal rights.

Return authorization must be obtained from the vendor before returned merchandise will be accepted. Authorization can be obtained by calling or faxing the vendor and requesting a Return Merchandise Authorization (RMA) number. Returned goods should always be accompanied by a clear problem description.

This page is intentionally left blank.

Chapter 1

Introduction

1.1. The Computer

Product Highlights

- 10~21.5" LCD Display w/ LED Backlight
- Flat panel with resistive touchscreen / projected capacitive touchscreen (depending on model)
- Front panel compliant with IP65
- Anti-scratch surface: 7H hardness (ASLAN-W9XXC)
- Mini PCIe expansion slot support
- Fanless cooling system
- Cable-less Design
- Low power consumption
- 2 x SMA antenna holes for optional WiFi function

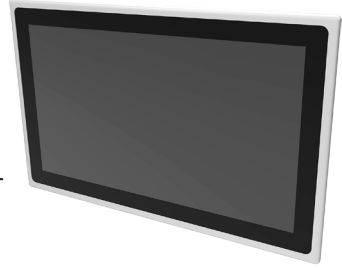

1.2. About this Manual

This manual is meant for the experienced users and integrators with hardware knowledge of personal computers. If you are not sure about the description in this manual, consult your vendor before further handling.

We recommend that you keep one copy of this manual for the quick reference for any necessary maintenance in the future. Thank you for choosing ARBOR products.

1.3. Specifications

System		
CPU	Intel® Core i5-6300U™ Processor 2.4GHz	
Memory	1 x 4GB DDR4 SO-DIMM RAM module installed	
LAN Chipset	1 x Intel® i219LM PCIe controller w/ iAMT	
	1 x Intel® i210IT PCIe controller	
Watchdog Timer	1~255 levels reset	
Storage		
Device	2 x 2.5" drive bay (default) (only for ASLAN-917X/W915C/W919C/W922C) 1 x mSATA	
Audio		
Device	Line Out / Mic In (Optional)	
LCD Display		
Size/Type	ASLAN-917X	17" TFT LCD Panel
	ASLAN-W910C	10.1" TFT LCD Panel
	ASLAN-W912C	11.6" TFT LCD Panel
	ASLAN-W915C	15.6" TFT LCD Panel
	ASLAN-W919C	18.5" TFT LCD Panel
	ASLAN-W922C	21.5" TFT LCD Panel
Max. Resolution	ASLAN-917X	1280x1024, SXGA
	ASLAN-W910C	1280 x 800, WXGA
	ASLAN-W912C/W922C	1920 x 1080, Full HD
	ASLAN-W915C/W919C	1366 x 768, WXGA
Max. Colors	ASLAN-917X/W915C/W919C/W922C: 16.2M	
	ASLAN-W910C/912C: 16.7M	
Luminance	ASLAN-917X/W910C	350 cd/m ²
	ASLAN-912C/W915C/W919C	300 cd/m ²
	ASLAN-W922C	250 cd/m ²
Touch Screen	ASLAN-917X: True flat resistive / projected capacitive touch panel ASLAN-W910C/W912C/W915C/W919C/W922C: Projected capacitive touch panel	
View Angle (U/D/R/L)	ASLAN-917X: 85°/85°/80°/80°	
	ASLAN-W910C/W912C/W915C/W919C/W922C: 80°/80°/85°/85°	
Power System		
Power Input	ASLAN-917X/W915C/W919C/W922C: DC 9~36V ASLAN-W910C/912C: DC 12~28V	

Introduction

Power Consumption	ASLAN-917X	Max. 29.0W (w/o I/O cards)
	ASLAN-W910C	Max. 23.0W (w/o I/O cards)
	ASLAN-W912C	Max. 24.0W (w/o I/O cards)
	ASLAN-W915C	Max. 30.8W (w/o I/O cards)
	ASLAN-W919C	Max. 29.0W (w/o I/O cards)
	ASLAN-W922C	Max. 38.1W (w/o I/O cards)
Qualification		
Certification	CE, FCC Class A	
Expansion		
Expansion Bus	1 x mSATA (SATA, Full Size) 1 x mPCIe (PCIex1+USB2.0, Full Size) 1 x mPCIe (PCIex1+USB2.0, Half Size)	
External I/O		
Video Output	1 x VGA / 1 x HDMI	
USB Ports	4 x Type-A USB 3.0/2.0 ports	
LAN	2 x RJ-45 GbE ports	
COM	ASLAN-917X/W915C/W919C/W922C: 4 x COM (RS-232/422/485) ASLAN-W910C/912C: 2 x COM (RS-232/422/485)	
DIO	4IN / 4OUT Digital I/O (optional) (only for ASLAN-917X/W915C/W919C/W922C)	
Mechanical		
Mounting Type	ASLAN-917X/W915C/W919C/W922C: Panel Mounting and VESA-100 Mounting ASLAN-W910C/W912C/: VESA-75 / Panel Mount (Bracket Optional)	
Chassis	Panel-mounting chassis, aluminum front bezel and SGCC steel chassis	
Dimension (W x H x D)	ASLAN-917X	470 x 295 x 56.2 mm (18.5" x 11.6" x 2.21")
	ASLAN-W910C	255 x 175 x 76.5 mm (10.04" x 6.89" x 3.01")
	ASLAN-W912C	306.2 x 206 x 76.5 mm (12.06" x 8.11" x 3.01")
	ASLAN-W915C	404 x 255 x 56.3 mm (15.91" x 10.04" x 2.22")
	ASLAN-W919C	470 x 295 x 56.2 mm (18.5" x 11.6" x 2.21")
	ASLAN-W922C	536 x 332 x 55.5 mm (21.1" x 13.07" x 2.19")
Weight (Net)	ASLAN-917X	6.5 kg (14.3 lb)
	ASLAN-W910C	2.41 kg (5.31 lb)
	ASLAN-W912C	2.48 kg (5.47 lb)
	ASLAN-W915C	4.46 kg (9.83 lb)
	ASLAN-W919C	5.68 kg (12.52 lb)
	ASLAN-W922C	7.01 kg (15.45 lb)
Environmental		
Operating Temp.	-20°C ~ 55°C (-4°F ~ 140°F)	
Storage Temp.	-30°C ~ 70°C (-22°F ~ 158°F)	
Operating Humidity	10 ~ 95% RH @ 55°C (non-condensing)	

Vibration	5 ~ 500Hz, 0.5Grms Random (w/ mSATA)
Shock	Operating 10G, 11ms Non-operating 30G, 11ms (w/ mSATA or SSD)
OS Support	
Windows 7 / Windows 8.1 / Windows 10 / Linux: Ubuntu	

1.4. Inside the Package

Upon opening the package, carefully inspect the contents. If any of the items is missing or appears damaged, contact your local dealer or distributor. The package should contain the following items:



1 x ASLAN-917X/W9XXC

*Product appearance varies by model.



1 x **Accessory Box** that contains the following items:

- Driver DVD
- User's manual
- Screws/cable
- 3-pin plug for terminal block

1.5. Ordering Information

ASLAN-917X	17" Intel® Core i5-6300U 2.4GHz Processor industrial panel PC with 4GB Memory
ASLAN-W910C-6300G4	10.1" Intel® Core i5-6300U 2.4GHz Processor Wide-screen industrial panel PC with 4GB Memory
ASLAN-W912C-6300G4	11.6" Intel® Core i5-6300U 2.4GHz Processor Wide-screen industrial panel PC with 4GB Memory
ASLAN-W915C-6300G4	15.6" Intel® Core i5-6300U 2.4GHz Processor Wide-screen industrial panel PC with 4GB Memory

Introduction

ASLAN-W919C-6300G4 18.5" Intel® Core i5-6300U 2.4GHz Processor Wide-screen industrial panel PC with 4GB Memory

ASLAN-W922C-6300G4 21.5" Intel® Core i5-6300U 2.4GHz Processor Wide-screen industrial panel PC with 4GB Memory

Chapter 2

Getting Started

2.1. Dimensions

ASLAN-917X

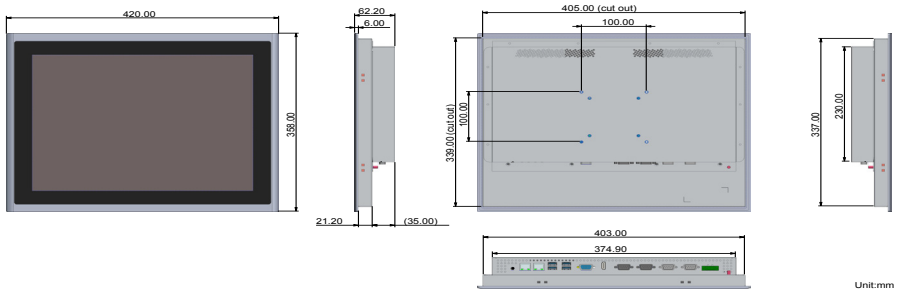

ASLAN-W910C

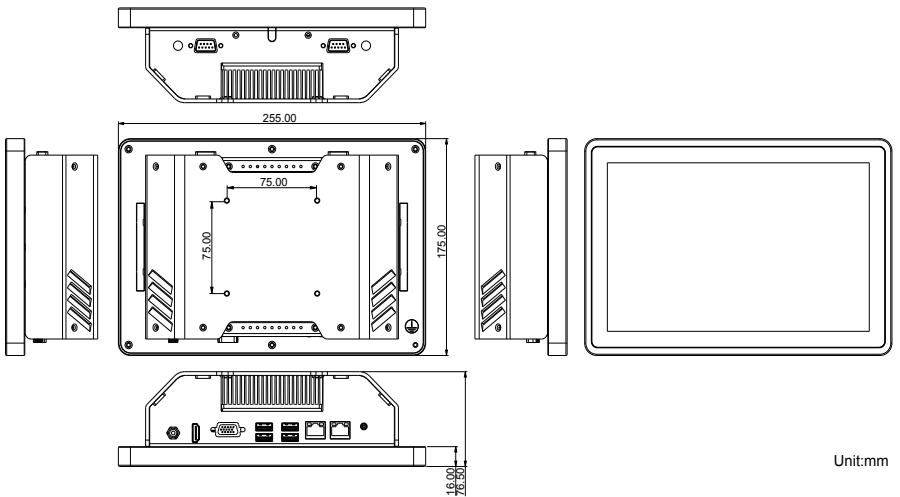

ASLAN-W912C

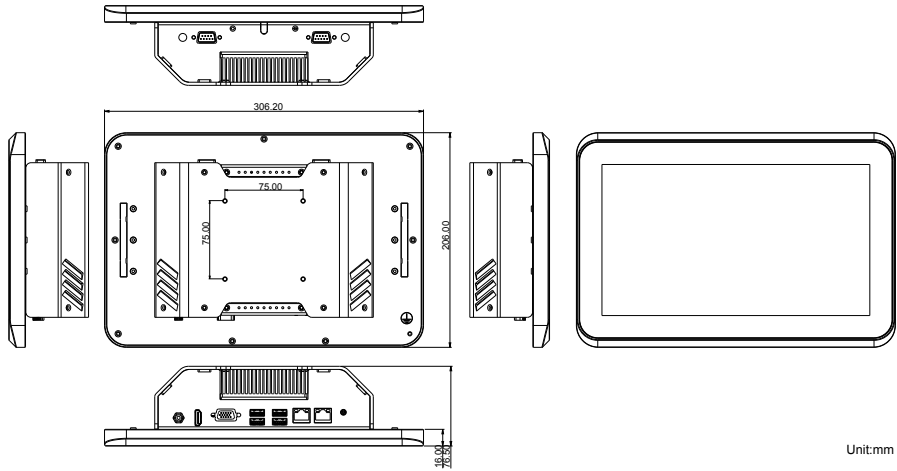

Unit:mm

ASLAN-W915C

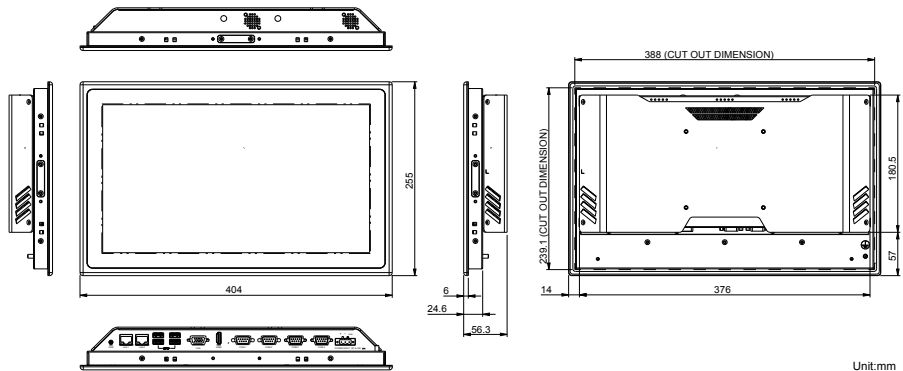

Unit:mm

ASLAN-W919C

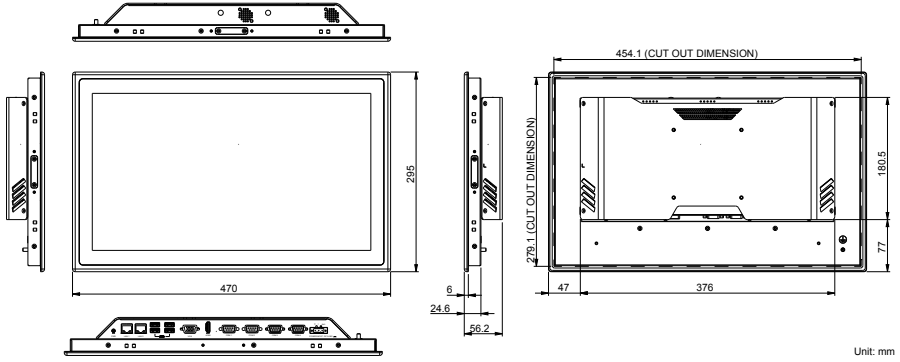

ASLAN-W922C

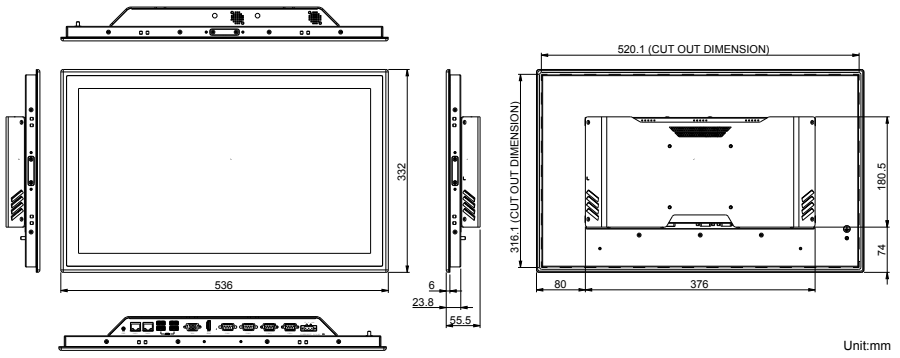

2.2. Tour the Computer

Take a look around the computer and find the external controls and connectors.

2.2.1. Front View



*Product appearance varies by model.

2.2.2. Top/Bottom View

ASLAN-W910C/912C



No.	Description
①	Power button
②	2 x RJ-45 GbE ports
③	4 x Type-A USB 3.0/2.0 ports
④	VGA port
⑤	HDMI port
⑥	Power jack
⑦	COM1 , RS-232/422/485 selectable
⑧	COM2, RS-232/422/485 selectable
⑨	2 x SMA antenna holes for optional WiFi function
⑩	

ASLAN-W915C/919C/922C

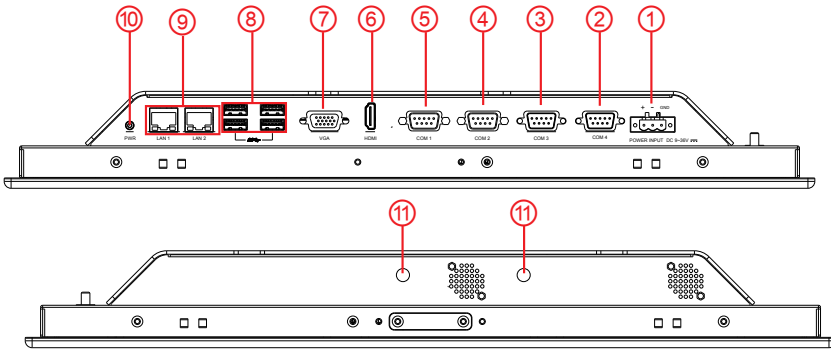

ASLAN-917X

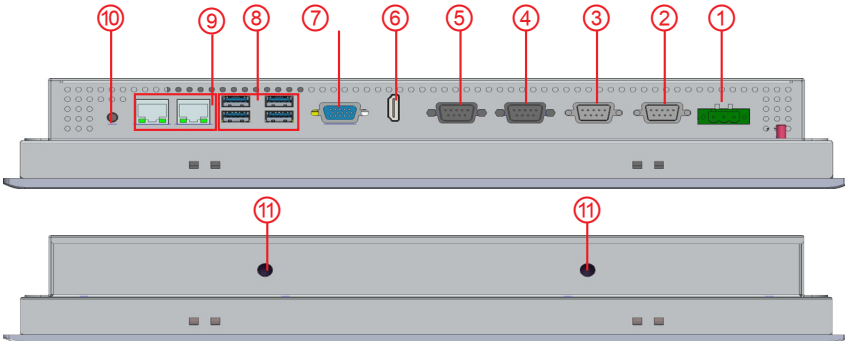

No.	Description
①	3-pin DC-in power receptacle
②	COM4, RS-232/422/485 selectable
③	COM3, RS-232/422/485 selectable
④	COM2, RS-232/422/485 selectable
⑤	COM1, RS-232/422/485 selectable
⑥	HDMI port
⑦	VGA port
⑧	4 x Type-A USB 3.0/2.0 ports
⑨	2 x RJ-45 GbE ports
⑩	Power button
⑪	2 x SMA Antenna Holes for optional WiFi Function

2.3. Driver Installation Note

The computer supports the operating systems Windows 7, Windows 8.1 and Windows 10. Find the necessary device drivers on the CD that comes with your purchase. Always follow the sequence below to install all drivers to prevent errors:

Windows 7 and Windows 8.1 64-Bit

For Windows 7 and 8.1 64-bit, please use system image to install the OS and the drivers.

Windows 10 64-Bit

Device	Driver Path
Chipset	\\Chipset_INF\Chipset_10.1.1.14_Public\SetupChipset.exe
Ethernet	\\Ethernet\Win10\PROWin64.exe
Graphic	\\Graphic\64bit\win64_154025.4463.exe
Audio	\\Audio\64bit\0006-64bit_Win7_Win8_Win81_Win10_R279.exe
ME	\\ME_11.0_Corporate_11.0.0.1177\SetupME.exe
RAID	\\Intel Rapid Storage Technology Driver (for RAID)\Intel Rapid Storage Technology Driver 14.8.0.1042\SetupRST.exe

This page is intentionally left blank.

Chapter 3

Engine of the Computer

3.1. Board Layout

Main Board (FMB-i89U1)

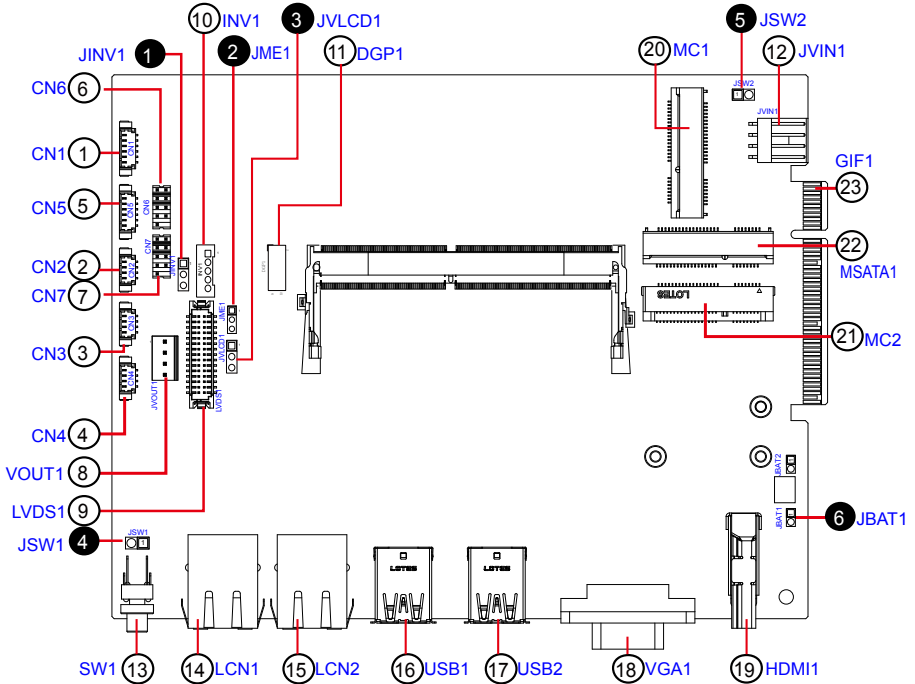

Jumpers

Label	Description
① JIN1	LVDS Inverter Voltage Select Jumper
② JME1	ME FLASH Select Jumper
③ JVLCD1	LVDS VDD Voltage Select Jumper
④ JSW1	Power Button
⑤ JSW2	Reset Button
⑥ JBAT1	CMOS Settings

Connectors

Label	Description
① CN1	Audio Connector
② ③ ④ CN2, 3, 4	USB 2.0 Connectors
⑤ CN5	PS2 Connector
⑥ ⑦ CN6, 7	COM1, 2 (RS-232/422-485 Selectable Serial Port)
⑧ JVOUT1	Power Output
⑨ LVDS1	LVDS Connector
⑩ INV1	LVDS BL Connector
⑪ DGP1	Debug Port
⑫ JVIN1	Power Input
⑬ SW1	Power Button
⑭ ⑮ LCN1, 2	RJ-45 Ethernet Connectors
⑯ ⑰ USB1, 2	USB 3.0/2.0 Connectors
⑱ VGA1	VGA Connector
⑲ HDMI1	HDMI Connector
⑳ ㉑ MC1, 2	PCI Express Mini-card Full/Half Size Socket
㉒ MSATA1	mSATA Socket
㉓ GIF1	PCIe Gold Finger Connector

Daughter Board (SCDB-1299H)

The daughter board is only available to ASLAN-917X/W915C/919C/922C/922C-IP.

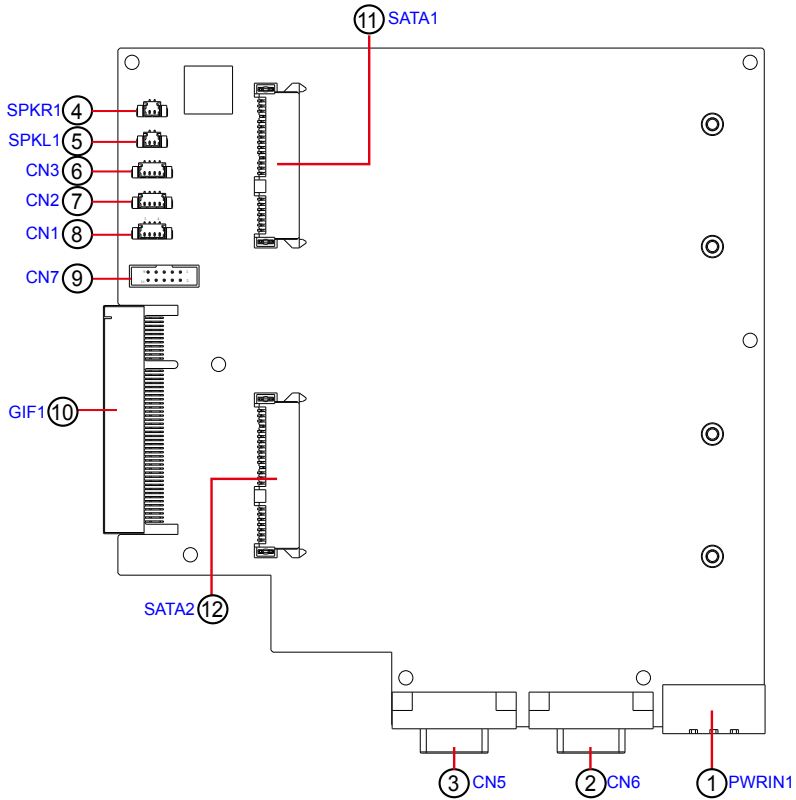

Connectors

Label	Description
①PWRIN1	Audio Connector
②③CN6, 5	COM4, 3 (RS-232/422/485 Selectable Serial Port)
④SPKR1	Speaker Output Connector
⑤SPKL1	Speaker Output Connector
⑥⑦⑧CN3, 2, 1	USB 3.0/2.0 Connector
⑨CN7	DIO Connector
⑩GIF1	Gold Finger Connector
⑪⑫SATA1	SATA HDD Connector

3.2. Jumpers and Connectors

3.2.1 Main Board (FMB-i89U1)

3.2.1.1. Jumpers

① JINV1

Function: Sets LVDS inverter voltage. (This jumper sets the voltage of LVDS connector INV1, which means this jumper decides the pin 1 of the LVDS connector INV1.)

Jumper Type: 2.54mm pitch, 1x3-pin header

Setting:

Pin	Description
1-2	+12V (default)
2-3	+5V

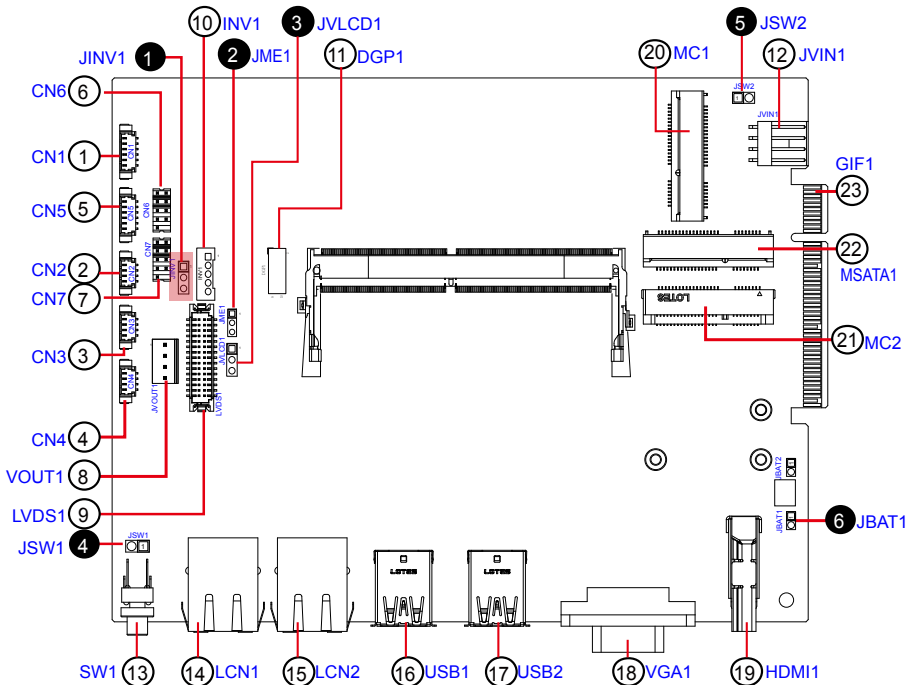
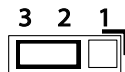
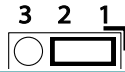

② JME1

Function: ME Flash Select Jumper
Jumper Type: 2.00mm pitch, 1x3-pin header
Setting:

Pin	Description
1-2	ME Flash disable (Default)
2-3	ME Flash enable

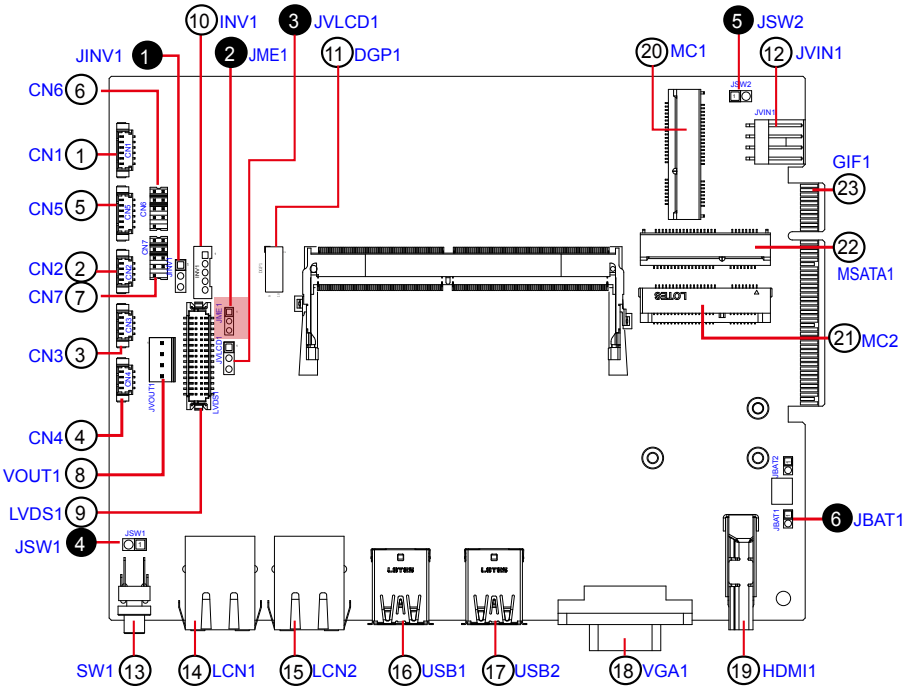
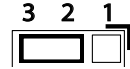
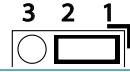

③ JVLCD1

Function: LVDS VDD Voltage Select Jumper

Jumper Type: 2.54mm pitch, 1x3-pin header

Setting:

Pin	Description
1-2	+3V (default)
2-3	+5V

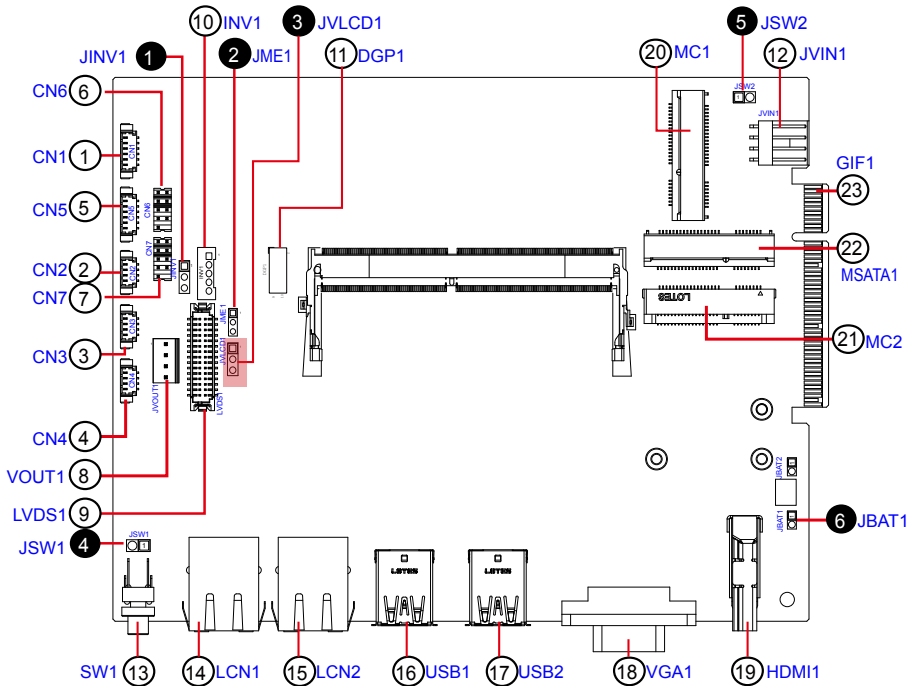
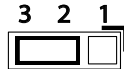
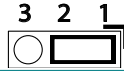

4 JSW1

Function: Power Button
Connector Type: 2.54 mm pitch 1x2-pin header
Setting:

Pin	Desc.
1	PWR_IN_SW#
2	GND



5 JSW2

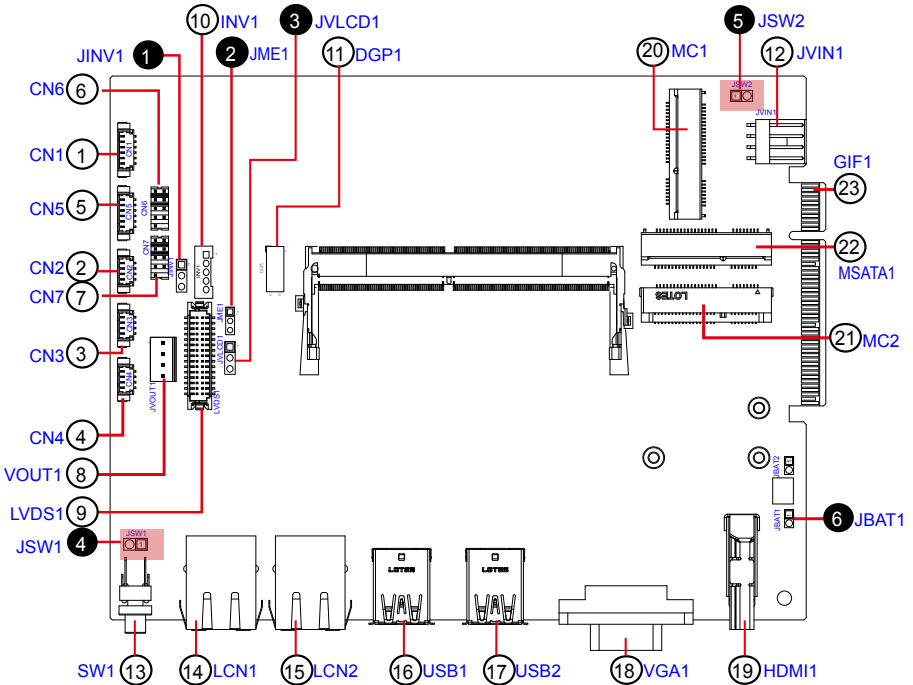

Function: Reset Button
Connector Type: 2.54 mm pitch 1x2-pin header
Setting:

Pin	Desc.
1	RST_SW#
2	GND

⑥ JBAT1

Function: Clears/keeps CMOS
Jumper Type: 2.00 mm pitch 1x2-pin header
Setting:

	Pin	Description	
Short	Clears CMOS		1 2
			
Open	Keeps CMOS (default)		1 2
			

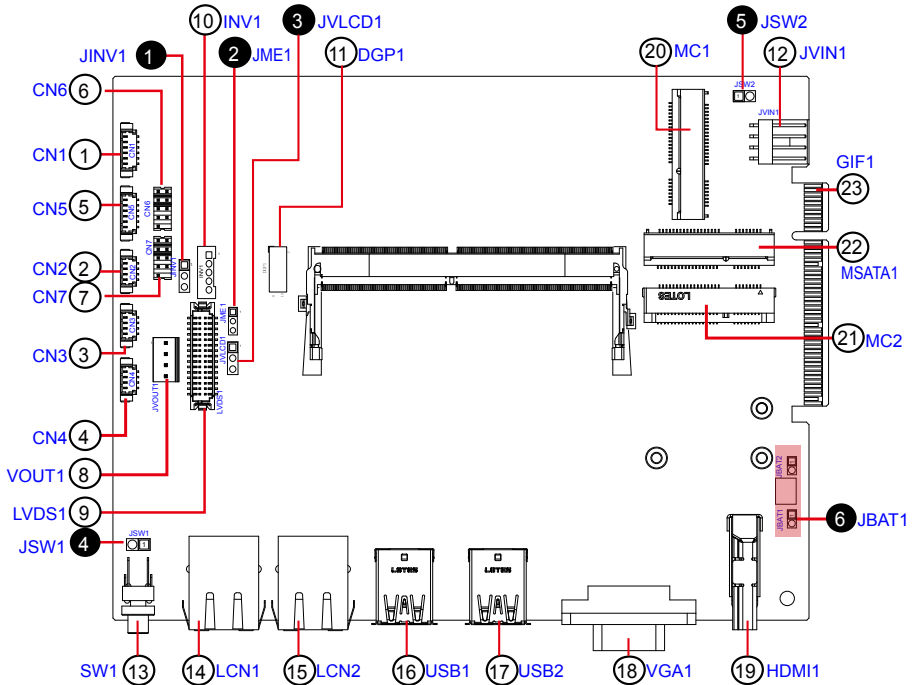

3.2.1.1. Connectors

① CN1

Function: Audio Connector
Connector Type: 1.25mm pitch 1x6 wire to board connector
Pin Assignment:

Pin	Desc.
1	MIC_L
2	MIC_R
3	GND
4	GND
5	Line Out_L
6	Line Out_R

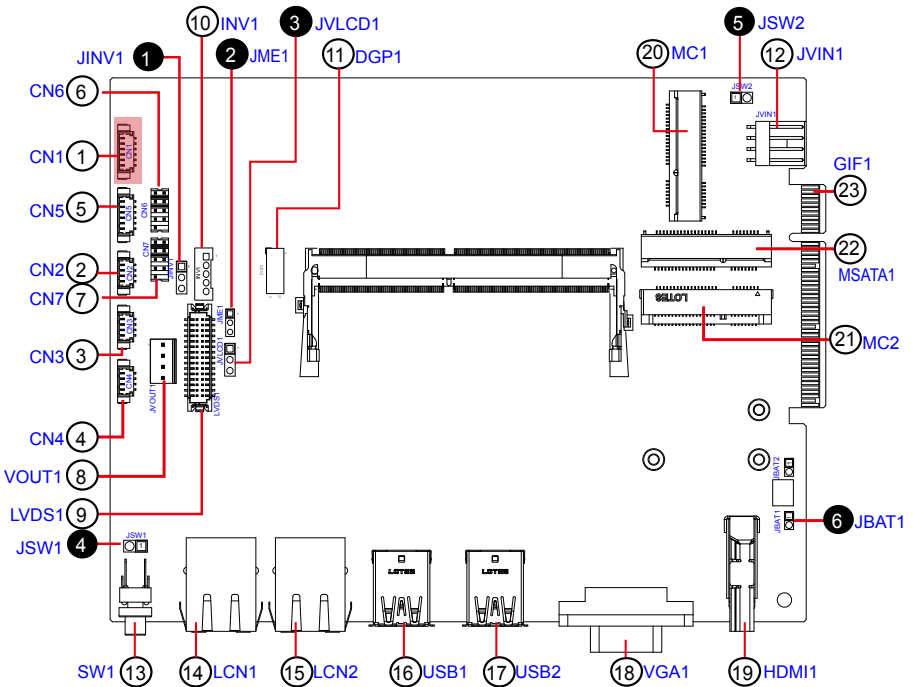
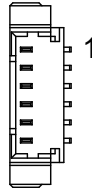

②③④ CN2, 3, 4

Function: USB 2.0 Connectors
Connector Type: 1.25mm pitch 1x4 wire to board connector
Pin Assignment:

Pin	Desc.
1	VCC5
2	DATA-
3	DATA+
4	GND

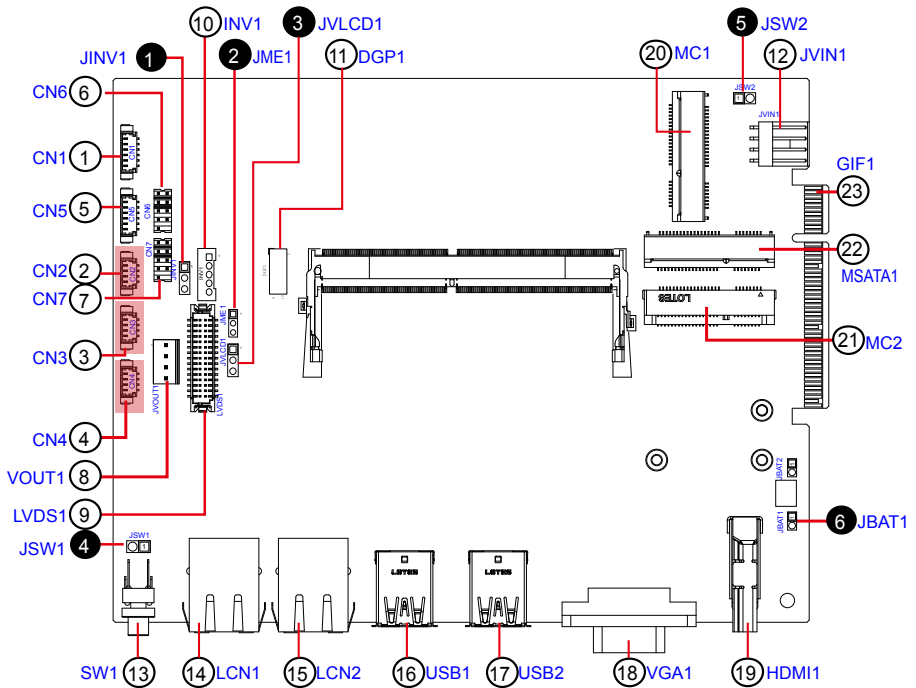
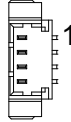

⑤ CN5

Function: PS2 Connector
Connector Type: 1.25mm pitch 1x6 wire to board connector
Pin Assignment:

Pin	Desc.
1	KDATA
2	GND
3	MDATA
4	KCLK
5	VCC5
6	MCLK

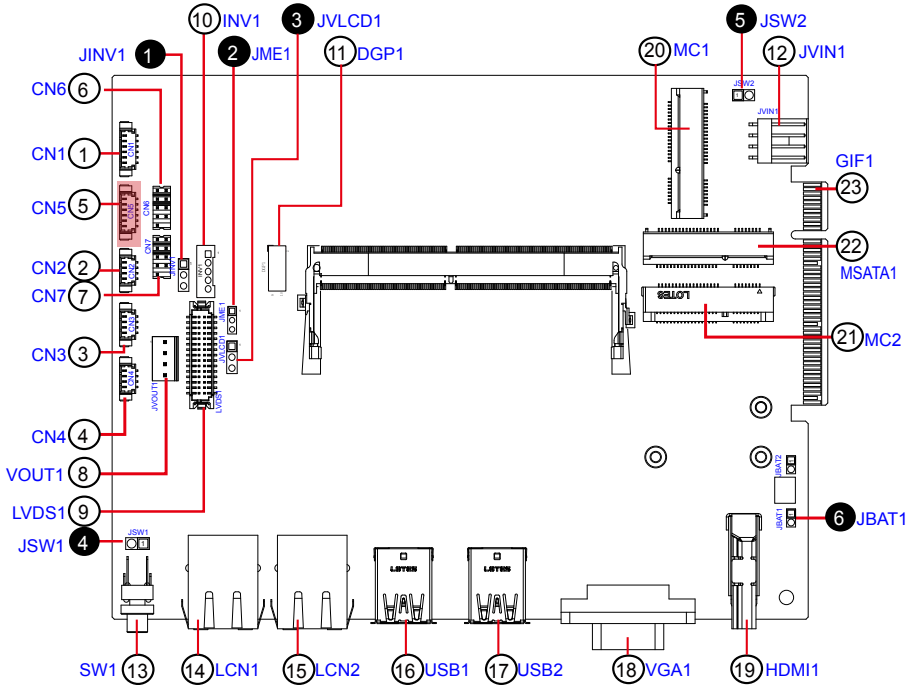
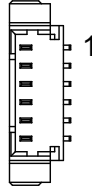

⑥⑦ CN6, CN7 (COM1, COM2)

Function: RS-232/422/485 selectable pin header

Connector Type: 2.00mm pitch 2x5-pin header

Pin Assignment:

Pin	Desc.	Pin	Desc.
1	DCD RS-485(D-) RS-422(TX-)	2	RXD RS-485(D+) RS-422(TX+)
3	TXD RS-422(RX+)	4	DTR RS-422(RX-)
5	GND	6	DSR
7	RTS	8	CTS
9	RI	10	N/C

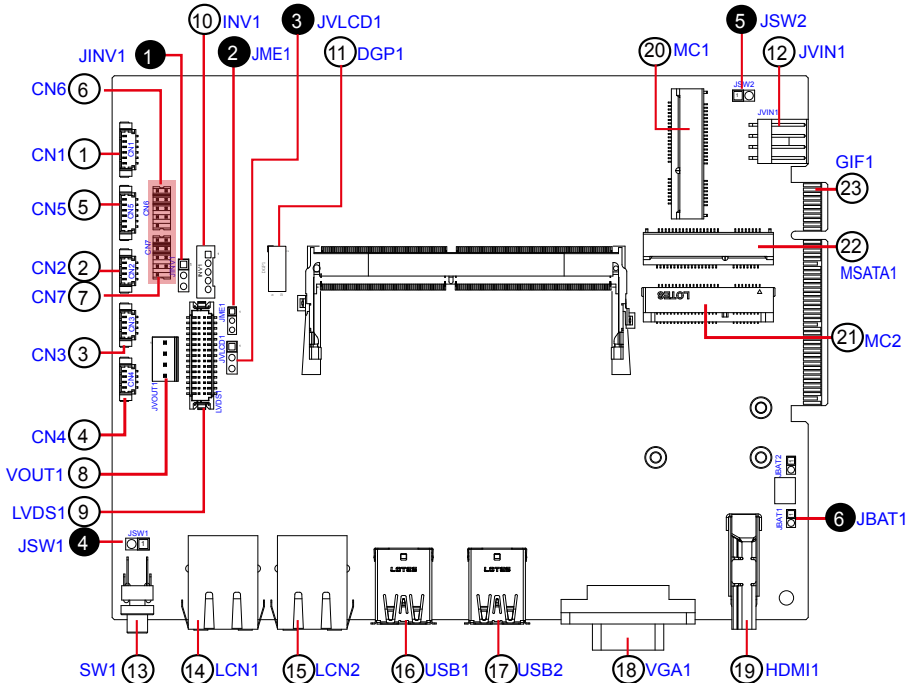
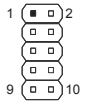

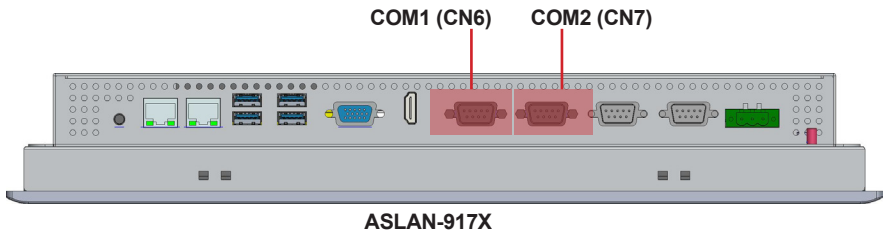
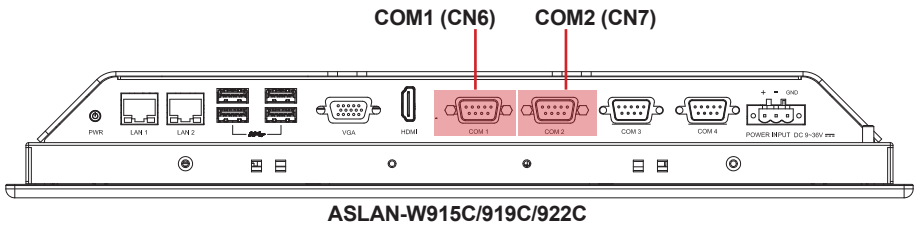
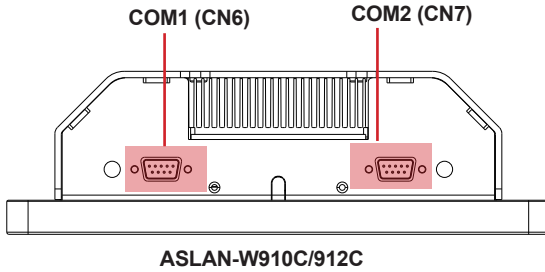

⑧ JVOUT1

Function: Power output
Connector Type: 2.54mm pitch 1x4-pin one-wall connector
Pin Assignment:

Pin	Desc.
1	VCC5
2	GND
3	GND
4	VCC12

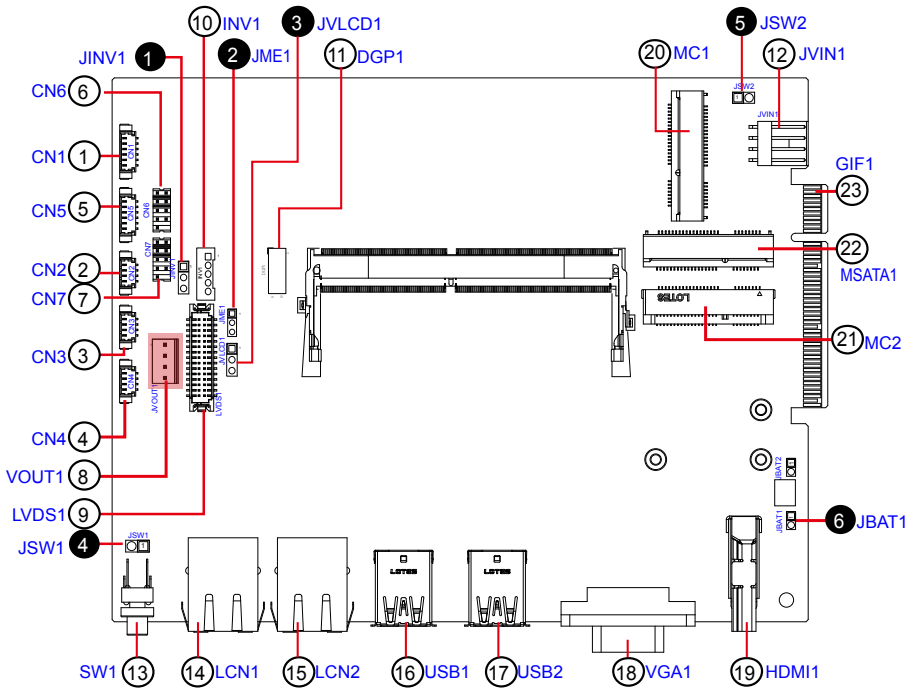

⑨ LVDS1

Function: LVDS Connector
Connector Type: Onboard 30-pin header
Pin Assignment:

Pin	Desc.	Pin	Desc.
2	VCC_LCD	1	VCC_LCD
4	LVDS_B_CLK+	3	LVDS_A_CLK+
6	LVDS_B_CLK-	5	LVDS_A_CLK-
8	GND	7	GND
10	LVDS_B0+	9	LVDS_A0+
12	LVDS_B0-	11	LVDS_A0-
14	GND	13	GND
16	LVDS_B1+	15	LVDS_A1+
18	LVDS_B1-	17	LVDS_A1-
20	GND	19	GND
22	LVDS_B2+	21	LVDS_A2+
24	LVDS_B2-	23	LVDS_A2-
26	GND	25	GND
28	LVDS_B3+	27	LVDS_A3+
30	LVDS_B3-	29	LVDS_A3-

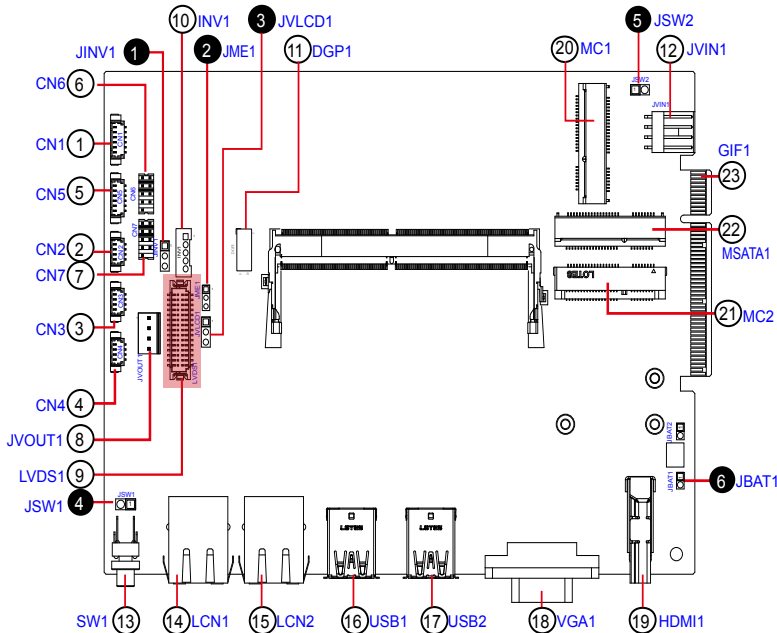
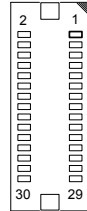

⑩ INV1

Function: LVDS BL Connector
Connector Type: 2.00mm pitch 1x5-pin one-wall connector
Pin Assignment:

Pin	Description
1	VCC_INV
2	GND
3	LVDS_BKLT_EN
4	LVDS_BKLTCTL
5	GND

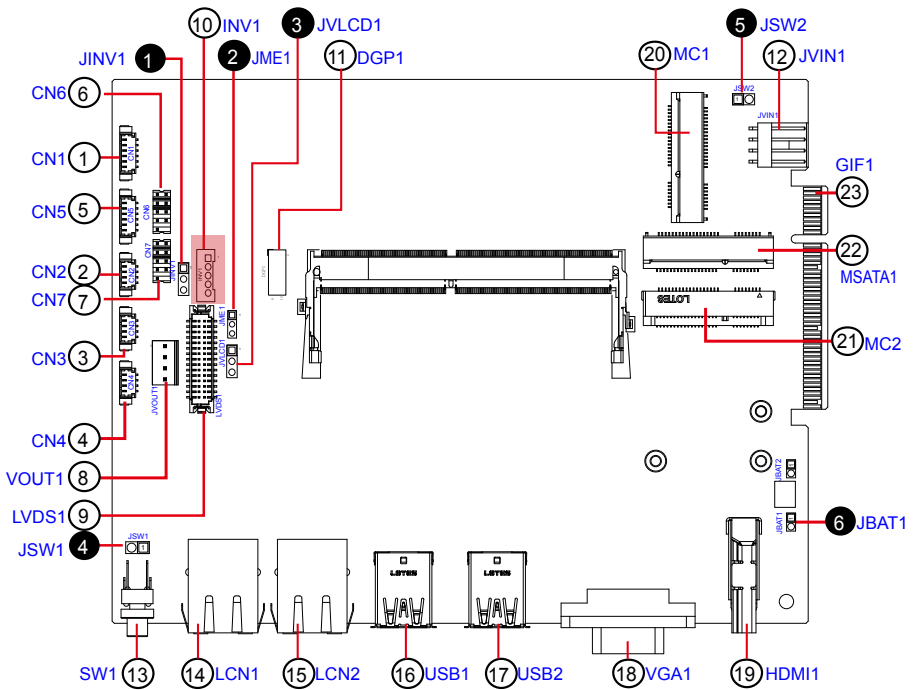

⑪ DGP1

Function: Debug port
Connector Type: 2.00mm-pitch 2x5-pin header
Pin Assignment:

Pin	Description	Pin	Description
1	24MHz Clock	2	GND
3	LPC_FRAME#	4	LPC_LAD0
5	PLTRST#	6	N.C
7	LPC_LAD3	8	LPC_LAD2
9	VCC3	10	LPC_LAD1

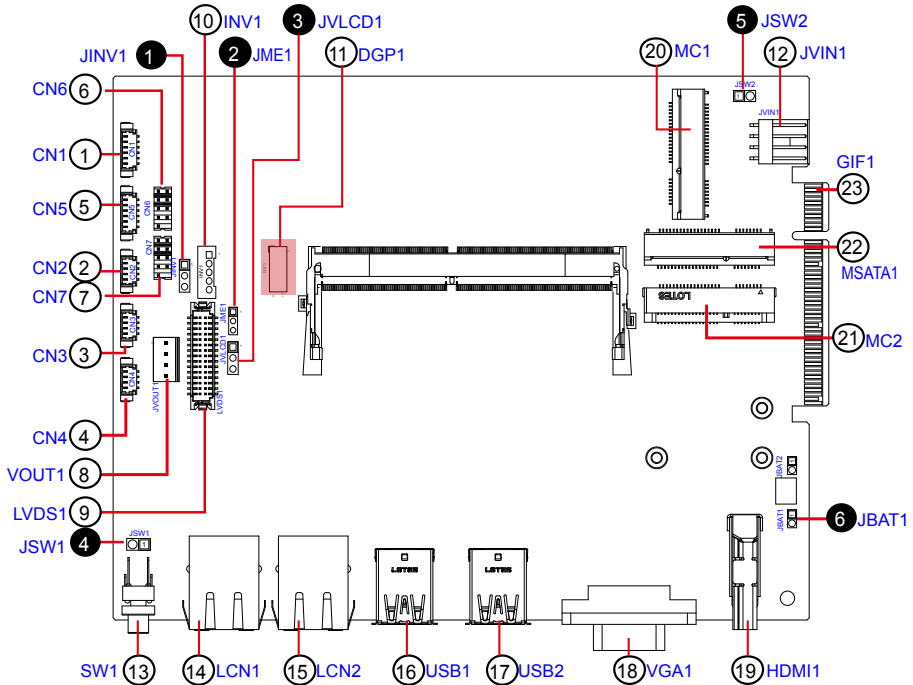
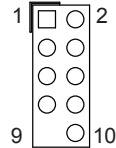

⑫ JVIN1

Function: Power Input Connector
Connector Type: 2.54mm pitch 1x4-pin wafer connector

Pin Assignment:

Pin	Desc.
1	VCC
2	VCC
3	GND
4	GND

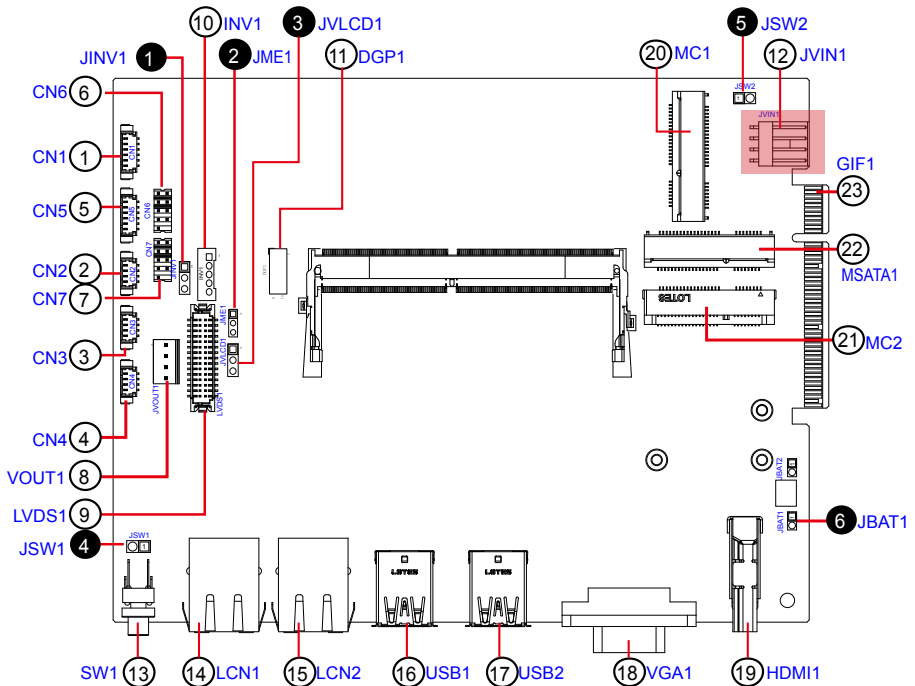

⑬ SW1

Function Power Button
Connector Type: LED tact switch with green and red colors
Pin Assignment:

Pin	Description	Pin	Description
1	GND	2	N/A
3	BTN	4	N/A
L1	SW1_LED_N	L2	SW1_LED_P

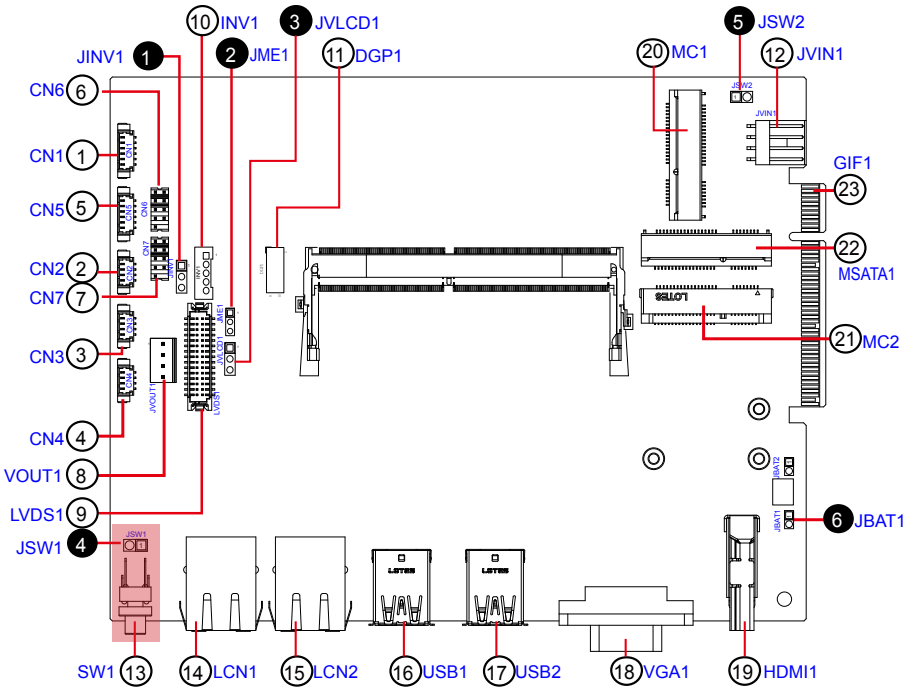
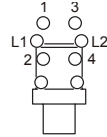

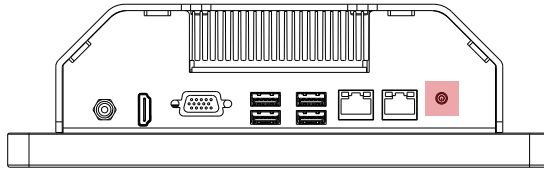

ASLAN-W910C/912C

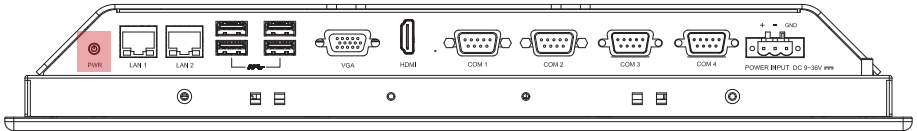

ASLAN-W915C/919C/922C

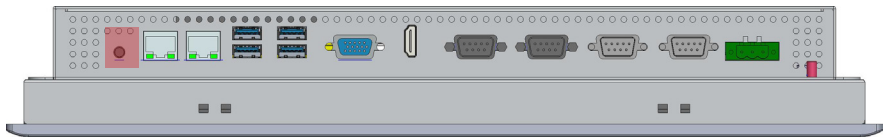

ASLAN-917X

⑭ ⑮ LCN1, 2

Function: RJ-45 Ethernet connectors
Connector Type: RJ-45 connector that supports 10/100/1000Mbps fast Ethernet
Pin Assignment: The pin assignments conform to the industry standard.

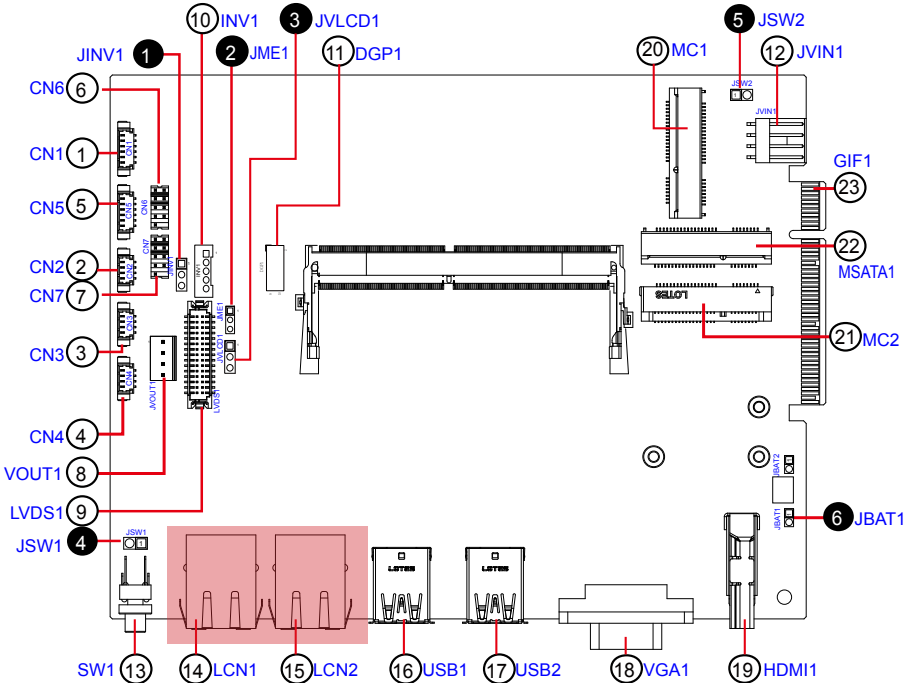
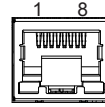

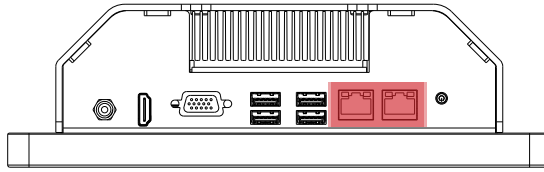

ASLAN-W910C/912C

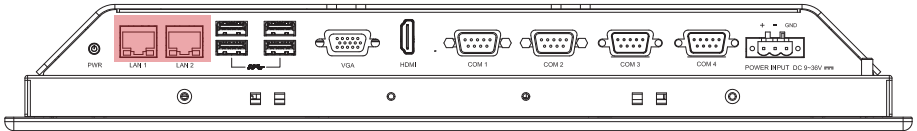

ASLAN-W915C/919C/922C

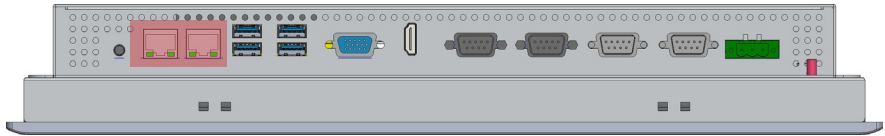

ASLAN-917X

⑩ ⑪ **USB1, 2**

Function: USB 3.0/2.0 Connectors

Connector Type: Double-stacked Type-A USB connectors

Pin Assignment: The pin assignments conform to the industry standard.

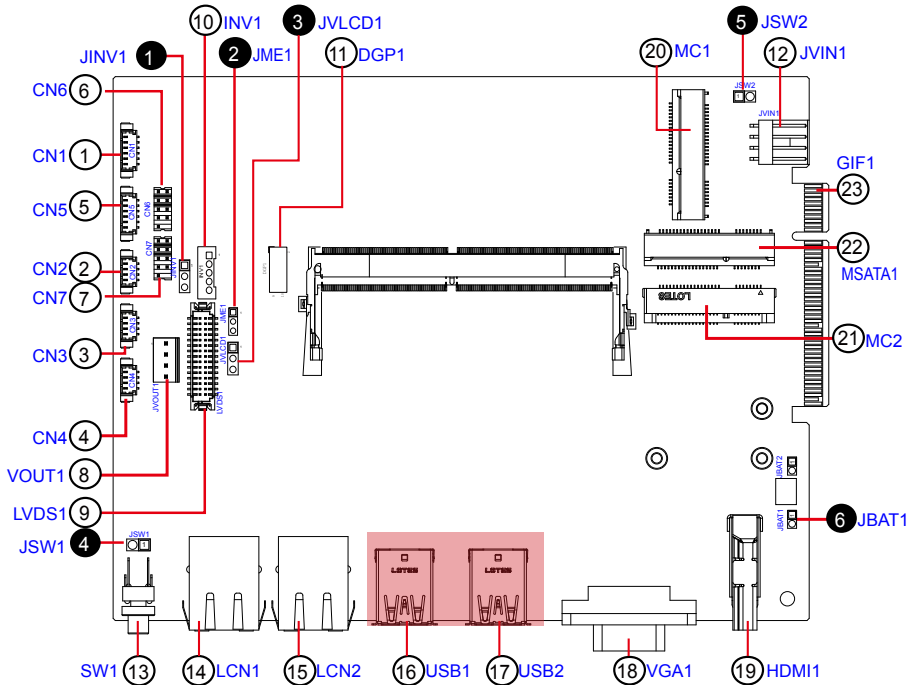

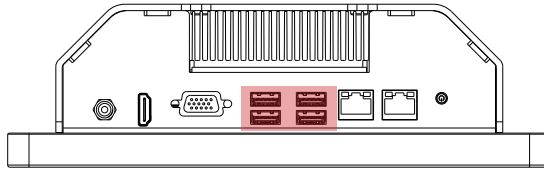

ASLAN-W910C/912C

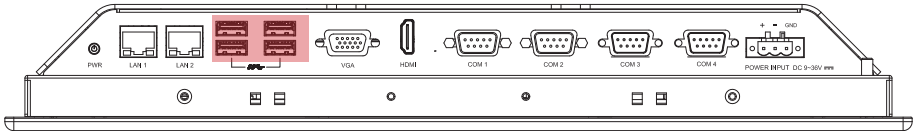

ASLAN-W915C/919C/922C

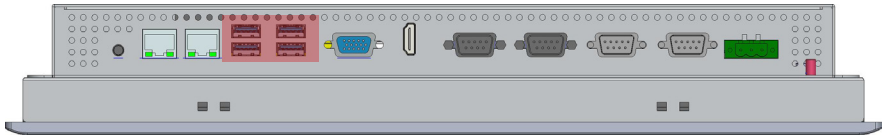

ASLAN-917X

⑱ VGA1

Function: VGA Connector
Connector Type: D-Sub 15-pin female connector
Pin Assignment:

Pin	Description	Pin	Description
1	RED	9	5V
2	GREEN	10	GND
3	BLUE	11	N/C
4	N/C	12	D-DATA
5	GND	13	H-SYNC
6	GND	14	V-SYNC
7	GND	15	D-DCLK
8	GND		

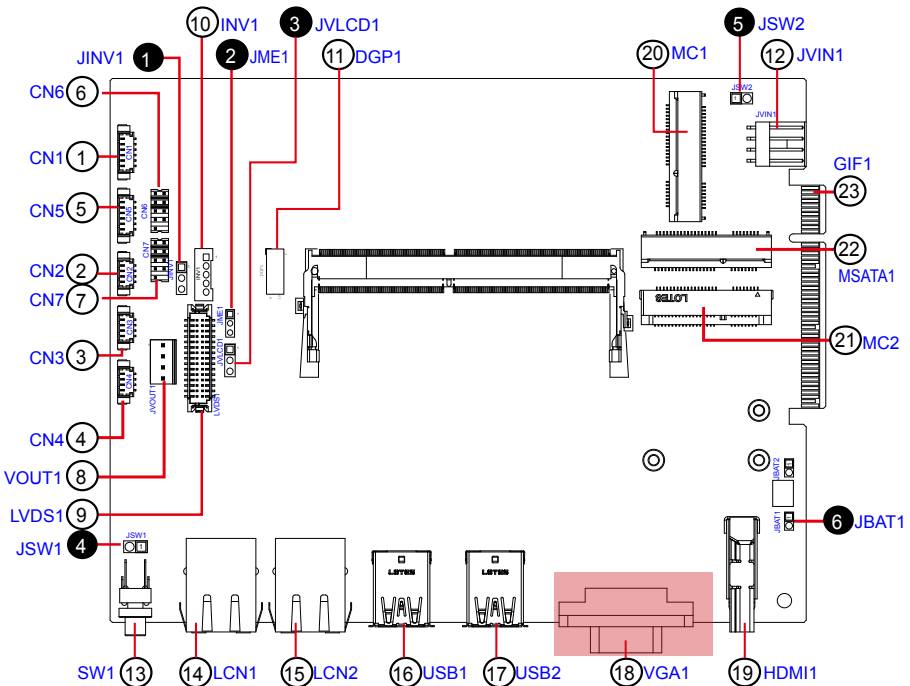
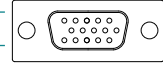

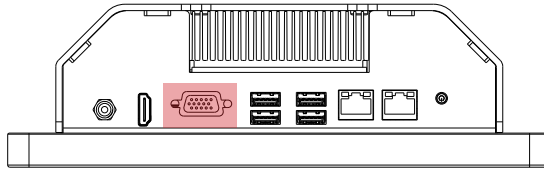

ASLAN-W910C/912C

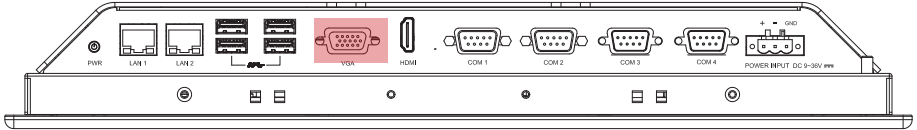

ASLAN-W915C/919C/922C

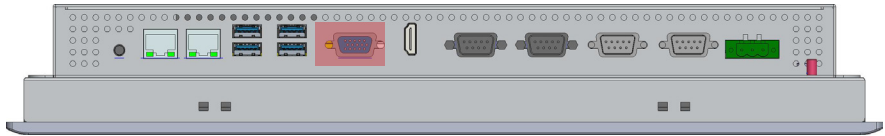

ASLAN-917X

19 HDMI1

Function: HDMI connector
Connector Type: 19-pin HDMI connector with flange
Pin Assignment: The pin assignments conform to the industry standard.

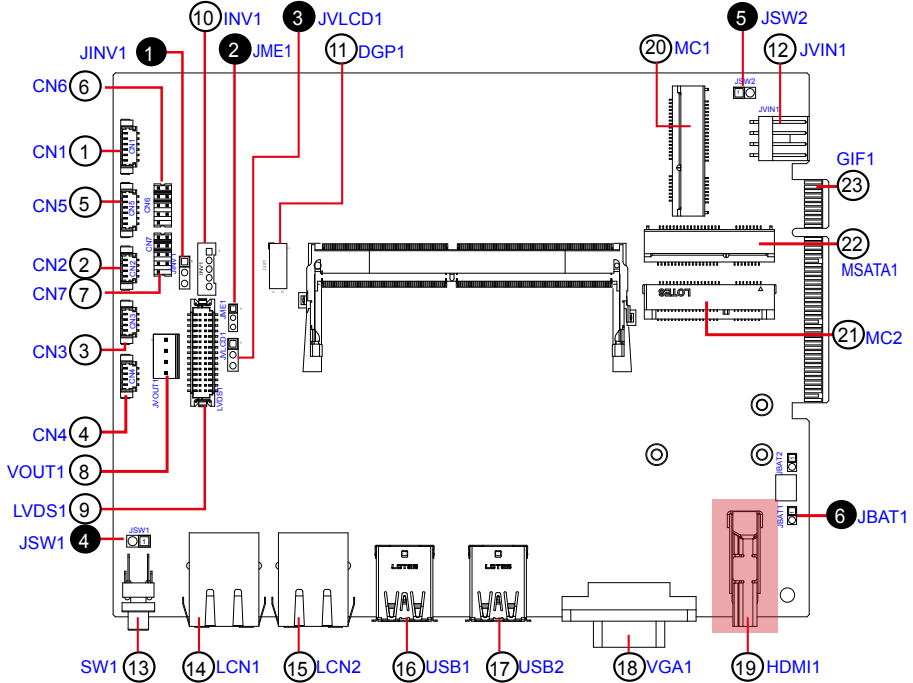
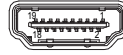

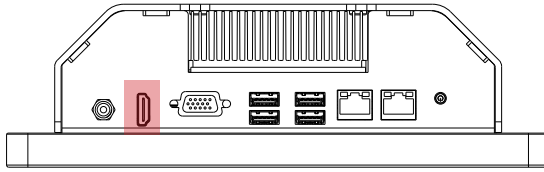

ASLAN-W910C/912C

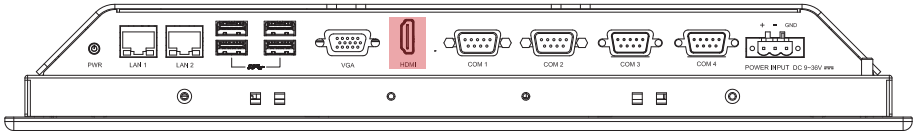

ASLAN-W915C/919C/922C

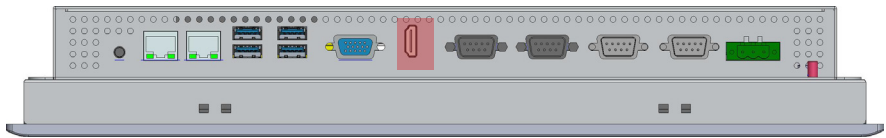

ASLAN-917X

⑳㉑ MC1, 2

Function: MC1: PCI Express Mini-card Full Size socket
 MC2: PCI Express Mini-card Half Size socket

Connector Type: Onboard 0.8mm pitch 52-pin edge card connector

Pin Assignment: The pin assignments conform to the industry standard.

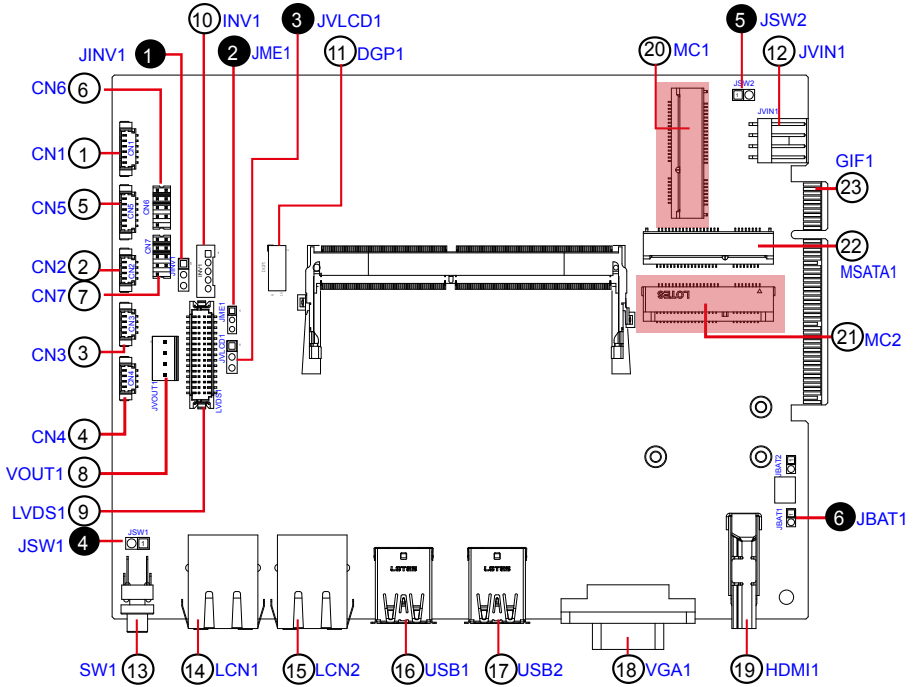
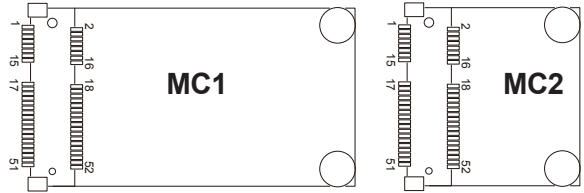

22 MSATA1

Function: mSATA socket
Connector Type: Onboard 0.8mm pitch 52-pin edge card connector
Pin Assignment: The pin assignments conform to the industry standard.

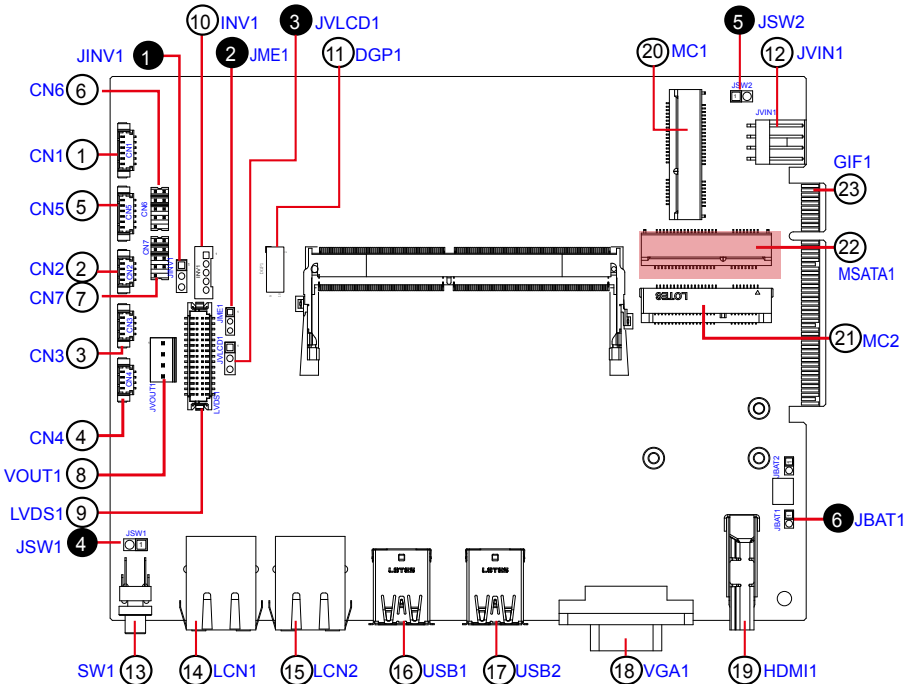
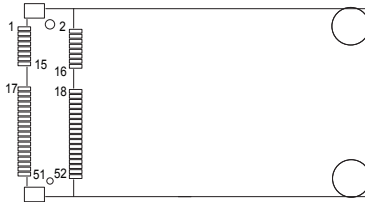

23 GIF1

Function: Gold Finger Connector for Daughter Board

Connector Type: Onboard 49-pin Golden Finger

Pin Assignment:

Pin	Desc.	Pin	Desc.	Pin	Desc.	Pin	Desc.
A1	NC	A26	NC	B1	+12VAUX	B26	GND
A2	+12VAUX	A27	GND	B2	+12VAUX	B27	NC
A3	+12VAUX	A28	GND	B3	+12VAUX	B28	NC
A4	GND	A29	NC	B4	GND	B29	GND
A5	LPC_LAD0	A30	NC	B5	SMBCLK_PCIE	B30	NC
A6	LPC_LAD1	A31	GND	B6	SMBDATA_PCIE	B31	NC
A7	LPC_LAD2	A32	NC	B7	GND	B32	GND
A8	LPC_LAD3	A33	NC	B8	NC	B33	NC
A9	NC	A34	GND	B9	LPC_FRAME#	B34	NC
A10	NC	A35	NC	B10	NC	B35	GND
A11	BUF_PLTRST#	A36	NC	B11	PCIE_WAKE#	B36	GND
A12	GND	A37	GND	B12	LPC_SERIRQ	B37	SATA0_TX+
A13	NC	A38	GND	B13	GND	B38	SATA0_TX-
A14	NC	A39	SATA1_TX+	B14	NC	B39	GND
A15	GND	A40	SATA1_TX-	B15	NC	B40	GND
A16	NC	A41	GND	B16	GND	B41	SATA0_RX+
A17	NC	A42	GND	B17	NC	B42	SATA0_RX-
A18	GND	A43	SATA1_RX+	B18	GND	B43	GND
A19	CLK_24M_GF	A44	SATA1_RX-	B19	NC	B44	GND
A20	GND	A45	GND	B20	NC	B45	USB2_1+
A21	NC	A46	GND	B21	GND	B46	USB2_1-
A22	NC	A47	NC	B22	GND	B47	GND
A23	GND	A48	NC	B23	NC	B48	PS_ON#
A24	GND	A49	GND	B24	NC	B49	GND
A25	NC			B25	GND		

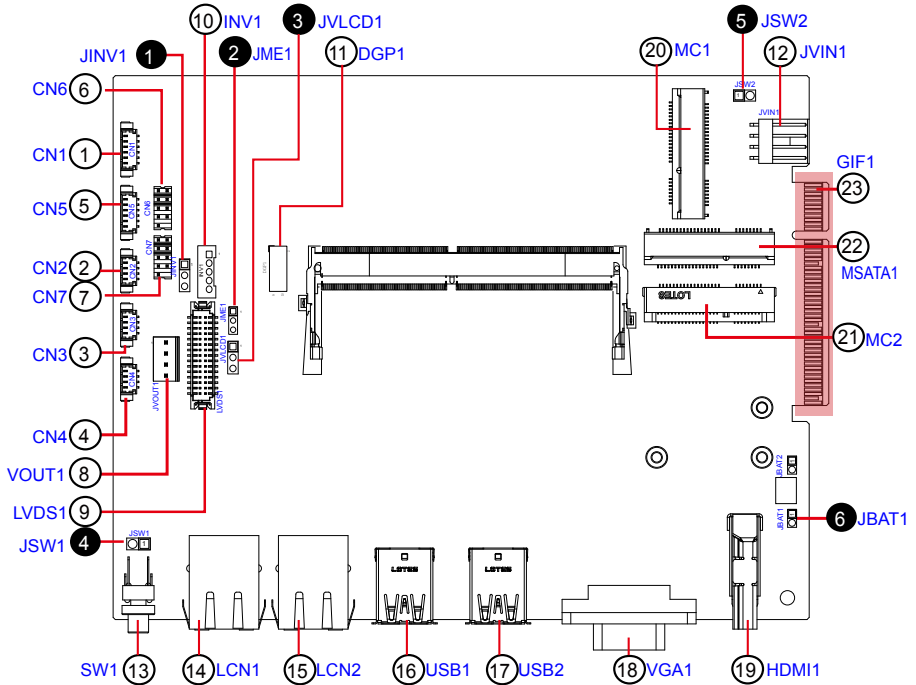

3.2.2 Daughter Board (SCB-1299H)

The daughter board is only available to ASLAN-917X/W915C/919C/922C/922C-IP.

① PWRIN1

Function: DC Adapter Power Input
Connector Type: 1x3-pin Terminal block
Pin Assignment:

Pin	Desc.
1	V+
2	V-
3	GND

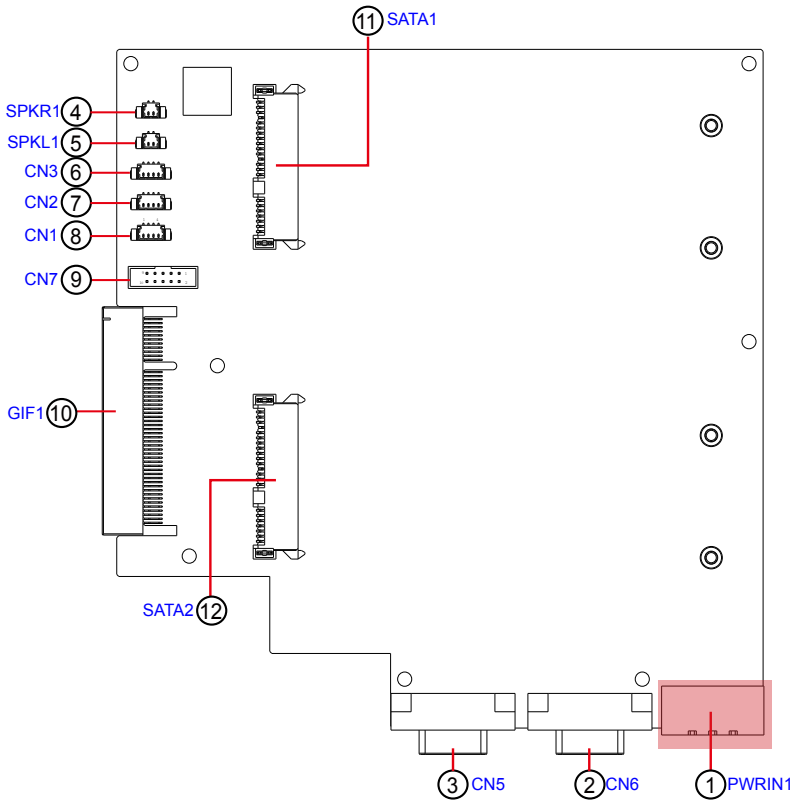
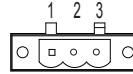

② ③ CN6, CN5 (COM4, COM3)

Function: RS-232/422/485 Selectable Serial Port

Connector Type: External 9-pin D-sub male connector

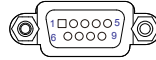

Pin Assignment:

RS232				RS422				RS485			
Pin	Desc	Pin	Desc	Pin	Desc	Pin	Desc	Pin	Desc	Pin	Desc
1	DCD	6	DSR	1	COM 422 TX-	6	N/C	1	COM 485 D-	6	N/C
2	RXD	7	RTS	2	COM 422 TX+	7	N/C	2	COM 485 D+	7	N/C
3	TXD	8	CTS	3	COM 422 RX+	8	N/C	3	N/C	8	N/C
4	DTR	9	RI	4	COM 422 RX-	9	N/C	4	N/C	9	N/C
5	GND			5	GND			5	GND		

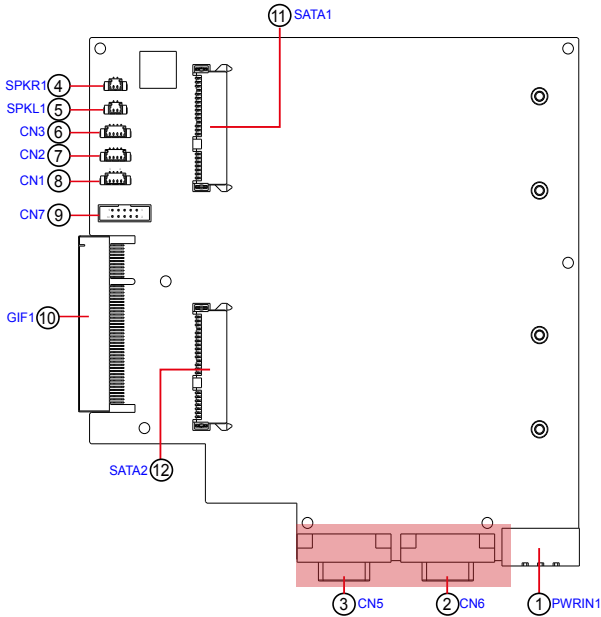

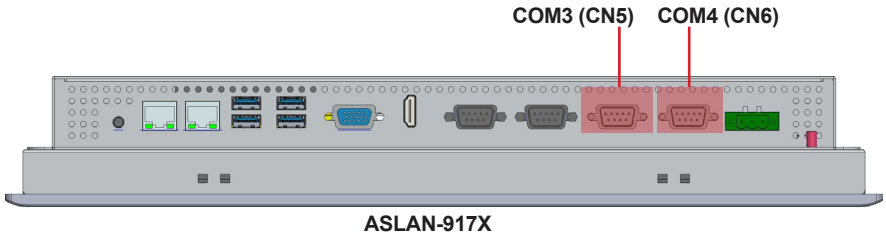
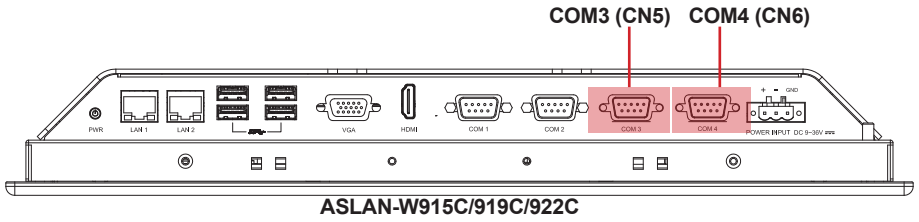

④ ⑤ SPKR1, SPKL1

Function: Speaker Output Connector

Connector Type: 1.25mm pitch 1x2 wire to board connector

Pin Assignment:

	Pin	Desc.
SPKR1	1	LOUT-R
	2	GND_AU1
SPKL1	1	LOUT-L
	2	GND_AU1

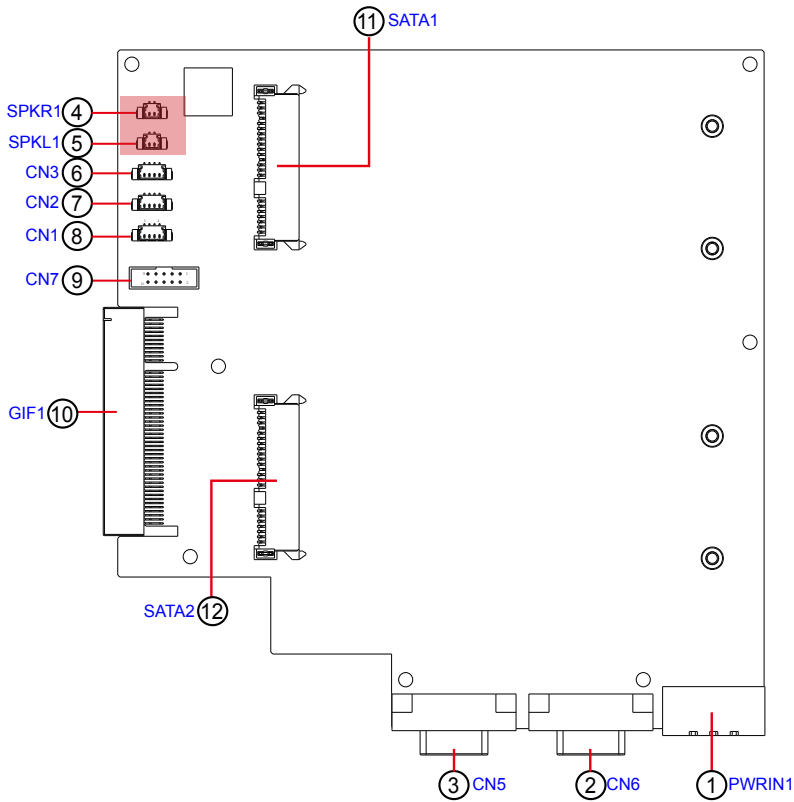
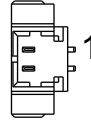

⑥ ⑦ ⑧ CN3, 2, 1

Function: USB 3.0/2.0 Connector

Connector Type: 1.25mm pitch 1x4 wire to board connector

Pin Assignment:

Pin	Desc.
1	VCC5
2	DATA-
3	DATA+
4	GND

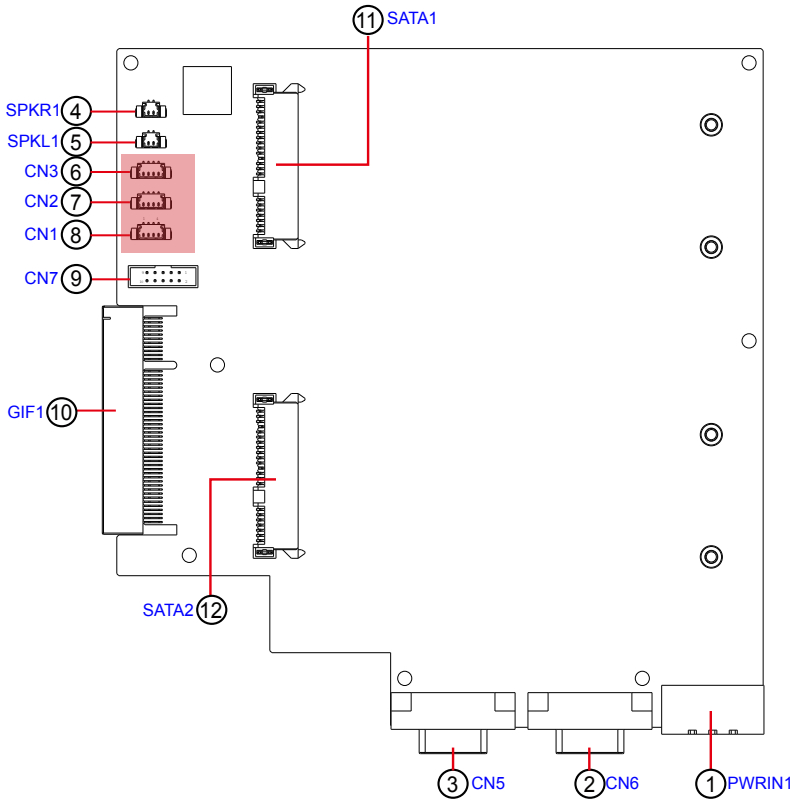
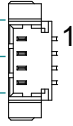

⑨ CN7

Function: DIO Connector
Connector Type: 2.0mm pitch 1x4 pin wafer connector
Pin Assignment:

Pin	Desc.	Pin	Desc.
1	DIN0	2	DOU0
3	DIN1	4	DOU1
5	DIN2	6	DOU2
7	DIN3	8	DOU3
9	N/C	10	N/C

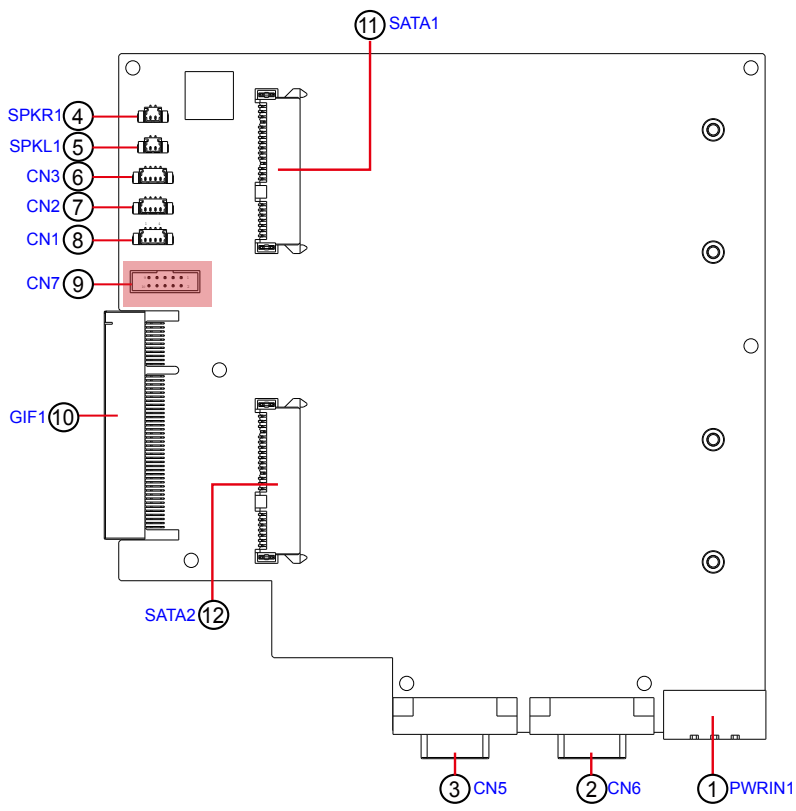
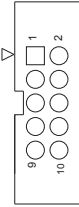

⑩ GIF1

Function: Connector for Main Board

Connector Type: Onboard 49-pin Connector

Pin Assignment:

Pin	Desc.	Pin	Desc.	Pin	Desc.	Pin	Desc.
A1	NC	A26	NC	B1	+12VAUX	B26	GND
A2	+12VAUX	A27	GND	B2	+12VAUX	B27	NC
A3	+12VAUX	A28	GND	B3	+12VAUX	B28	NC
A4	GND	A29	NC	B4	GND	B29	GND
A5	LPC_LAD0	A30	NC	B5	SMBCLK_PCIE	B30	NC
A6	LPC_LAD1	A31	GND	B6	SMBDATA_PCIE	B31	NC
A7	LPC_LAD2	A32	NC	B7	GND	B32	GND
A8	LPC_LAD3	A33	NC	B8	NC	B33	NC
A9	NC	A34	GND	B9	LPC_FRAME#	B34	NC
A10	NC	A35	NC	B10	NC	B35	GND
A11	BUF_PLTRST#	A36	NC	B11	PCIE_WAKE#	B36	GND
A12	GND	A37	GND	B12	LPC_SERIRQ	B37	SATA0_TX+
A13	NC	A38	GND	B13	GND	B38	SATA0_TX-
A14	NC	A39	SATA1_TX+	B14	NC	B39	GND
A15	GND	A40	SATA1_TX-	B15	NC	B40	GND
A16	NC	A41	GND	B16	GND	B41	SATA0_RX+
A17	NC	A42	GND	B17	NC	B42	SATA0_RX-
A18	GND	A43	SATA1_RX+	B18	GND	B43	GND
A19	CLK_24M_GF	A44	SATA1_RX-	B19	NC	B44	GND
A20	GND	A45	GND	B20	NC	B45	USB2_1+
A21	NC	A46	GND	B21	GND	B46	USB2_1-
A22	NC	A47	NC	B22	GND	B47	GND
A23	GND	A48	NC	B23	NC	B48	PS_ON#
A24	GND	A49	GND	B24	NC	B49	GND
A25	NC			B25	GND		

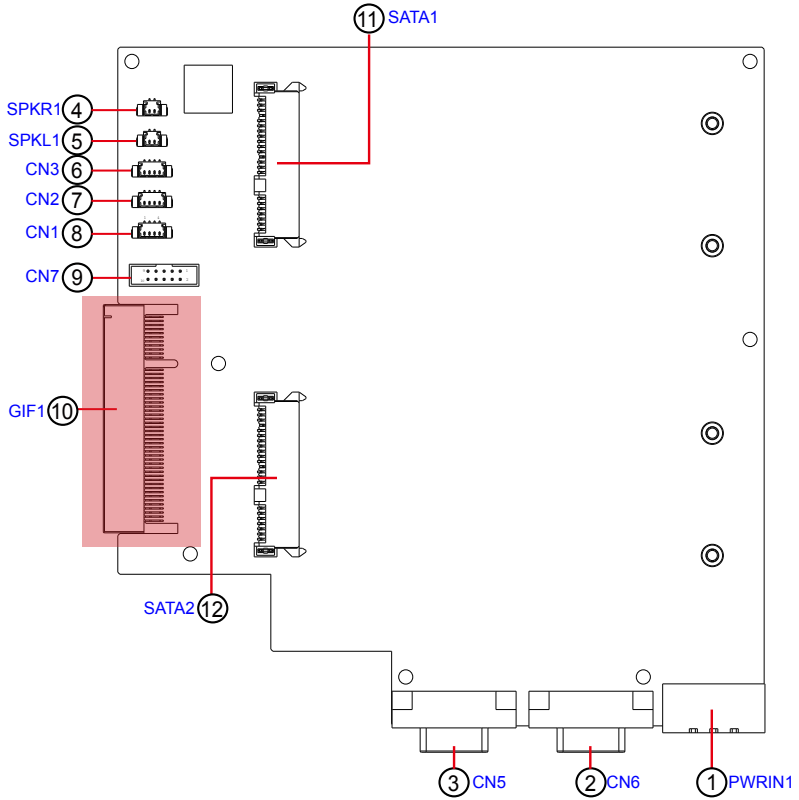

⑪ ⑫ SATA1, SATA2

Function: SATA HDD connector

Connector Type: SATA port with data +power vertical connector (7+15pin)

Pin Assignment:

Pin	Desc.	Pin	Desc.	Pin	Desc.
S1	GND	P1	3.3V	P8	5V
S2	TX+	P2	3.3V	P9	5V
S3	TX-	P3	3.3V	P10	GND
S4	GND	P4	GND	P11	NC
S5	RX-	P5	GND	P12	GND
S6	RX+	P6	GND	P13	NC
S7	GND	P7	5V	P14	NC
				P15	NC

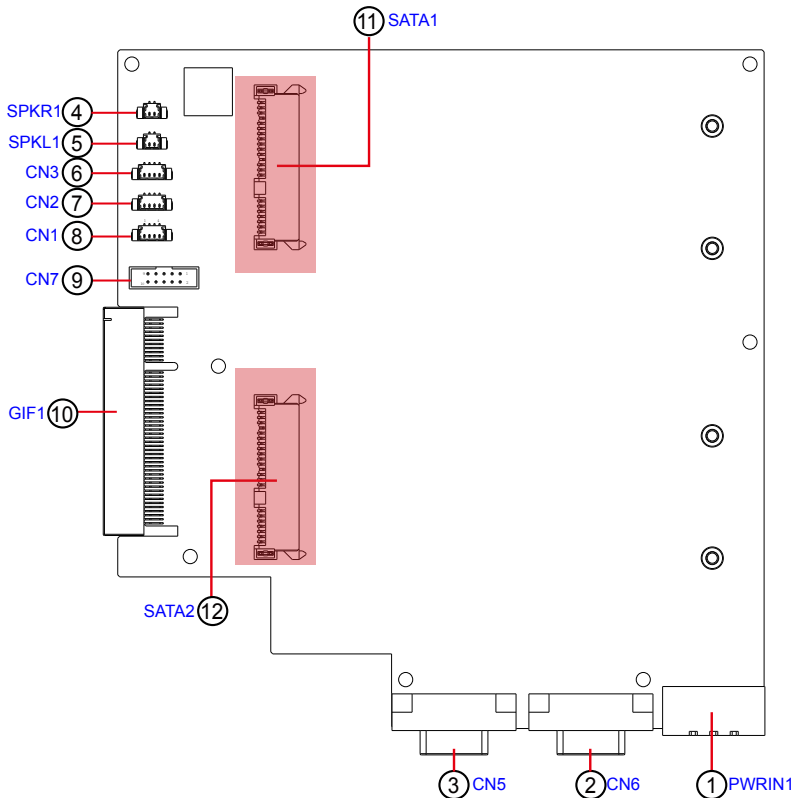
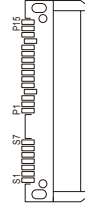

Chapter 4

Installation & Maintenance

4.1. Disassembly the Computer

The computer's carrier board comes with some connectors to join some devices and also some jumpers to alter hardware configuration. Follow through the guide below to access these components inside the computer.

4.1.1 ASLAN-W910C/912C

The ASLAN-W910C/W912C comes with a main board inside. The disassembly procedures for these two models are similar. This section will use the ASLAN-W910C to illustrate the procedures.

1. Loosen and remove the 8 screws from the computer's rear side. Then, loosen and remove the COM/VGA port screws from the top and bottom side of the computer.



2. Dismount the rear cover from the computer. The inside of the computer comes to view. With the bottom side facing you, lift up the bottom side of the main board and disconnect the three connectors as shown below.

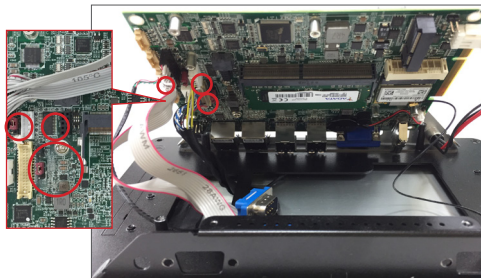

- Carefully lift the main board and set it aside on a flat surface.



- Then you are ready to access the components of the computer.

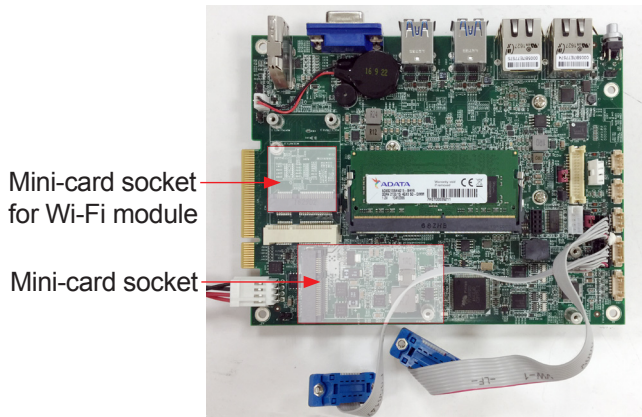

4.1.2. ASLAN-917X/W915C/919C/922C

The ASLAN-917X/W915C/W919C/W922C come with a main board and a daughter board inside. The disassembly procedures for these models are similar. This section will use the ASLAN-W922C to illustrate the procedures.

1. Loosen and remove the 8 screws from the computer's rear side.

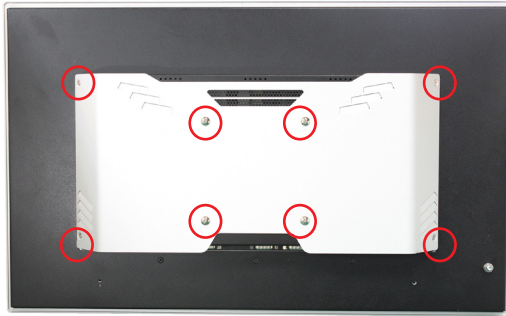

2. Dismount the rear cover from the computer. The inside of the computer comes to view.

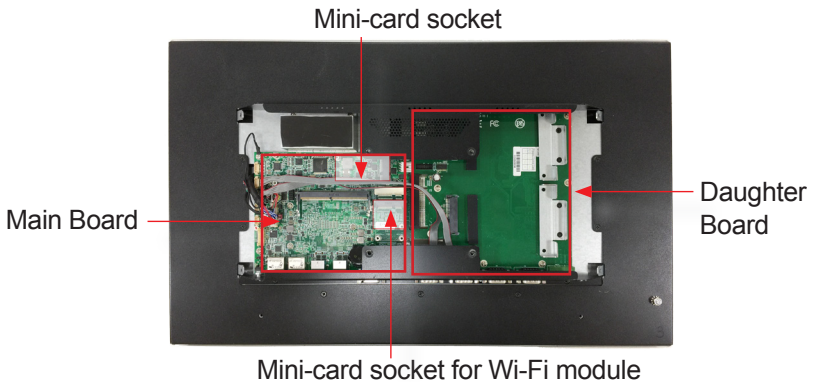

4.2. Install Hardware

4.2.1. Install Wi-Fi Module

The computer comes with one Mini-card socket to load the computer with a wireless module of PCI Express Mini-card form factor: This section will guide you to install the Wi-Fi module.

1. Locate the **PCI Express Mini-card** socket for wireless module.

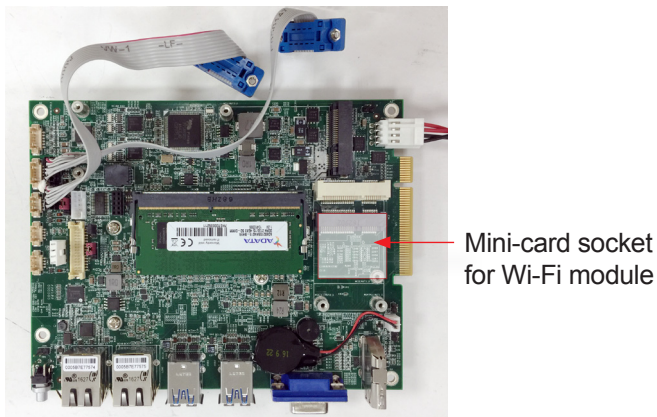

Note the socket has a break among the connector .

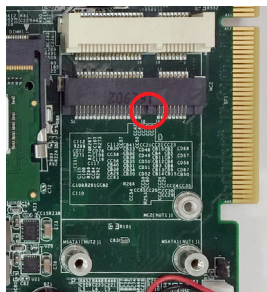

The module's key notch should meet the connector's break.

2. Prepare the Wi-Fi module kit. The module is a half-size module of **PCI Express Mini-card** form factor, with two U.FL connectors, one is “MAIN”, and the other is “AUX”.

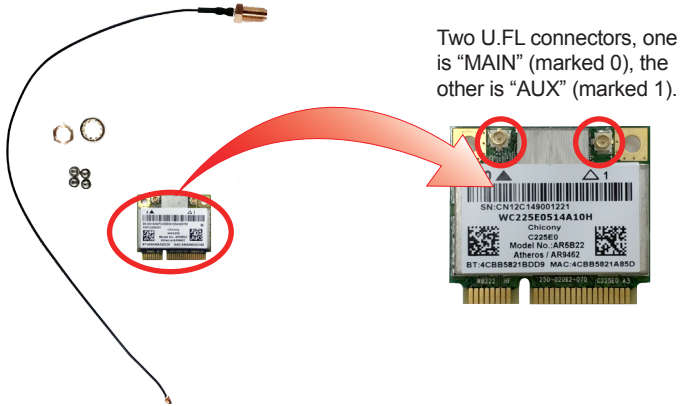

3. Have the RF antenna. The antenna has an SMA connector on one end and an MHF connector on the other.

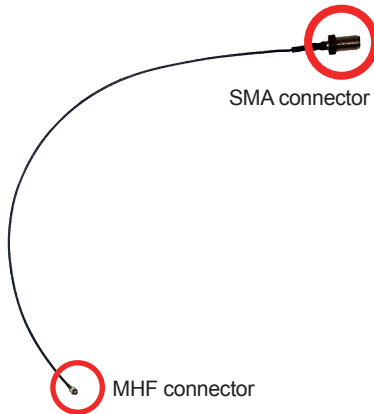

4. Connect the RF antenna's MHF connector to the Wi-Fi module's main connector marked 0. If you are going to connect a secondary antenna, connect it to the connector marked 1.

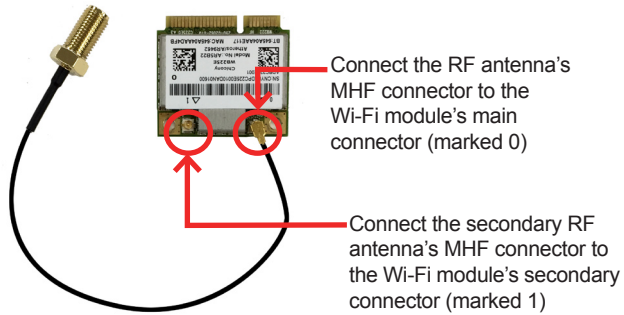

5. Plug the Wi-Fi module to the socket's connector by a slanted angle. Fully plug the module, and note the notch on the wireless module should meet the break of the connector.



6. Press the module down and fix the module in place using two screws.



7. Remove a plastic plug from the computer's bottom (or top) side to make an antenna hole. Keep the plastic plug for any possible restoration in the future.

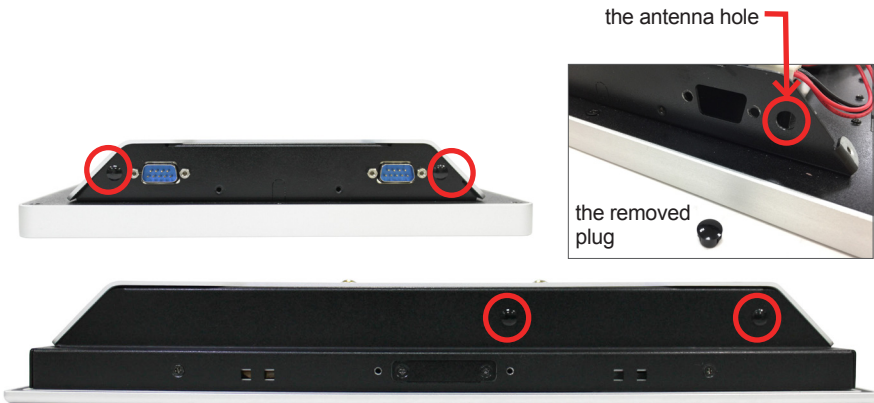

8. From the other end of the RF antenna, which is an SMA connector, remove the washer and the nut. Save the washer and nut for later use. Note the SMA connector has the form of a threaded bolt, with one flat side.

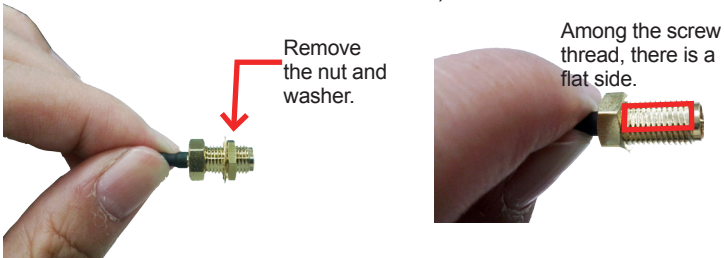

9. Pull the SMA connector through the above mentioned antenna hole. Note to meet the aforesaid flattened side with the antenna hole's flat side.

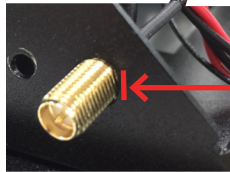

Arrange the flat side of the SMA connector to meet the flat side of the antenna hole.

10. Mount the washer first and then the nut to the SMA connector. Make sure the nut is tightened.

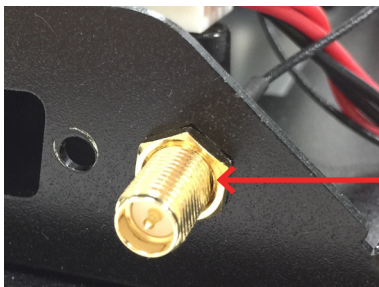

Mount the washer and the nut to the SMA connector. Tighten the nut.

11. Restore the computer's bottom cover and fasten the screws.

12. Have the external antenna(s). Screw and tightly fasten the antenna(s) to the SMA connector.



4.2.1. Install mSATA Module

To install an mSATA storage module to the computer:

1. Locate the socket for mSATA modules.

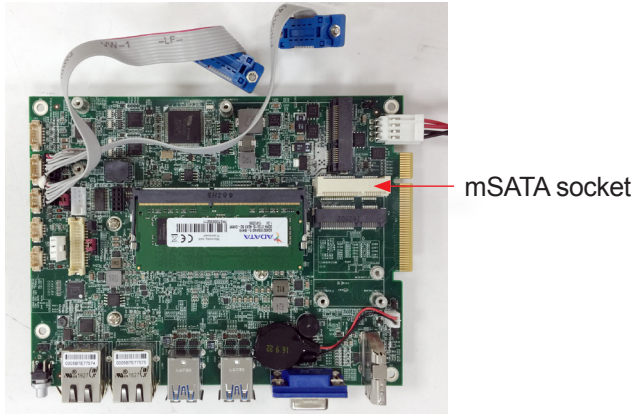

2. Confront the mSATA module's edge connector with the socket's connector. Align the module's key notch the connector's break.

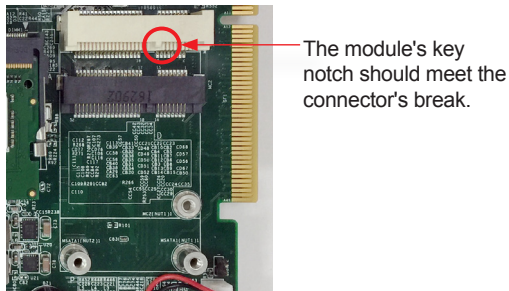

3. Fully plug the module until it cannot be plugged any more.

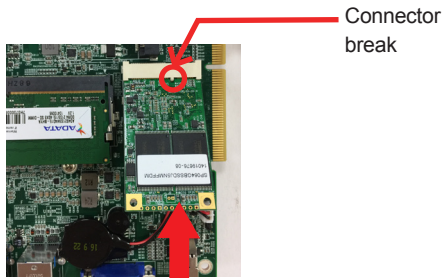

Fully plug the module.

4. Press the module down and fix the module in place using two screws.



4.2.1. Install SSD or HDD

The ASLAN-917X/W915C/W919C/W922C comes with two 2.5" drive bays for 2.5" HDD or SSD storage device. To install 2.5" HDD or SSD to the computer,

1. Locate the 2.5" drive bays inside the computer.

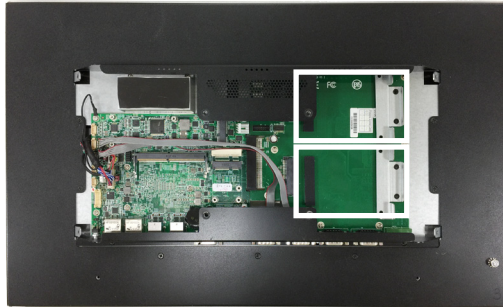

2. For the drive bay you want to use, remove the 2 screws securing the bracket.

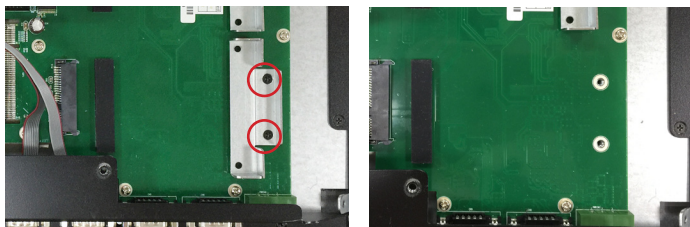

3. Fix the 2.5" HDD or SSD storage device to the bracket you just removed using 2 screws coming with the storage device kit.



- Slide the storage device into the SATA connector. Then fix the bracket using the 2 screws removed in step 2.



SATA Connector

- Repeat steps 2 to 5 to install 2.5" HDD or SSD to the other bay.



4.3. Mount the Computer

Integrate the computer to where it works by mounting it to a wall in the surroundings or to the rear of a display panel.

4.3.1. Panel Mounting

For ASLAN-917X and ASLAN-W915C/919C/922C

1. Put the panel PC into correct-sized opening on a panel or other fixture.
2. Put the provided panel-mounting clamps into holes around edges of the panel PC.
3. Tightly fasten the panel-mounting clamps around edges.

Example of ASLAN-917X

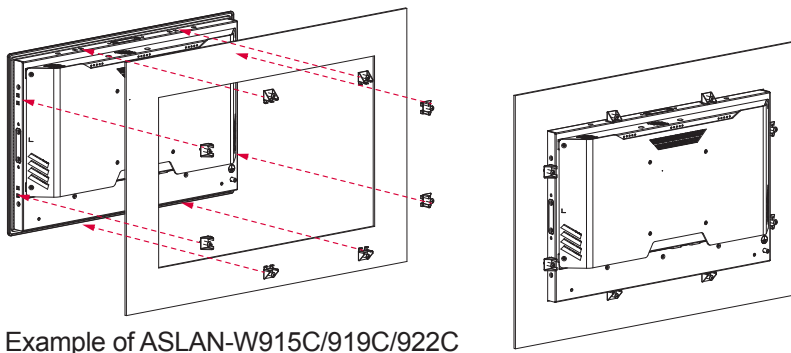
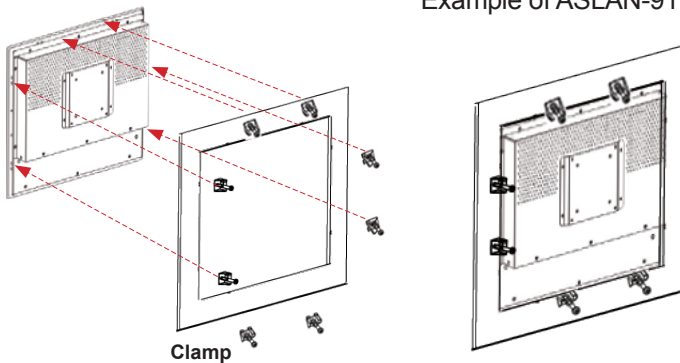

Example of ASLAN-W915C/919C/922C

For ASLAN-W910/912C

The ASLAN-W910/912C comes with optional panel mounting brackets for panel mounting. Follow the steps below to mount the computer on a panel.

1. Disassembly the rear cover as described in [4.1. Disassembly the Computer](#) on page [58](#).
2. Remove the cover plate of the holes for the mounting brackets. Secure the mounting brackets to the rear cover by fastening the 3 screws. Then restore the rear cover to the computer.

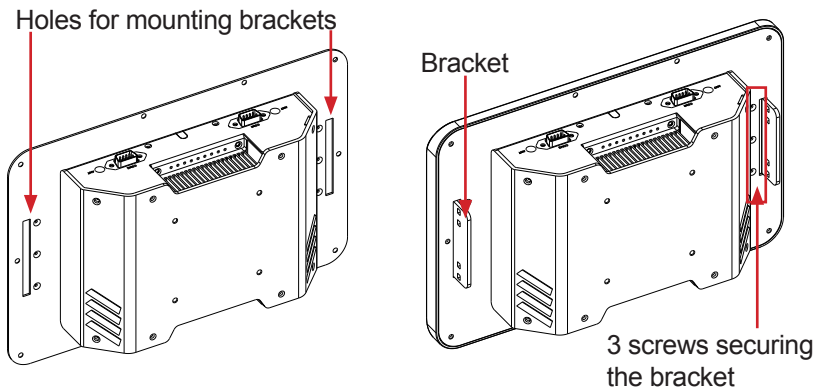

3. Put the panel PC into correct-sized opening on a panel or other fixture.

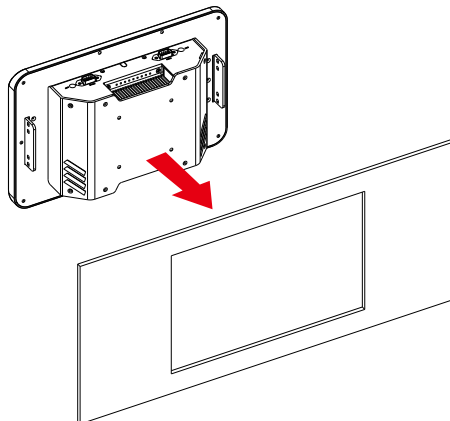

4. Put the provided panel-mounting clamps into holes around edges of the panel PC.
5. Tightly fasten the panel-mounting clamps around edges.

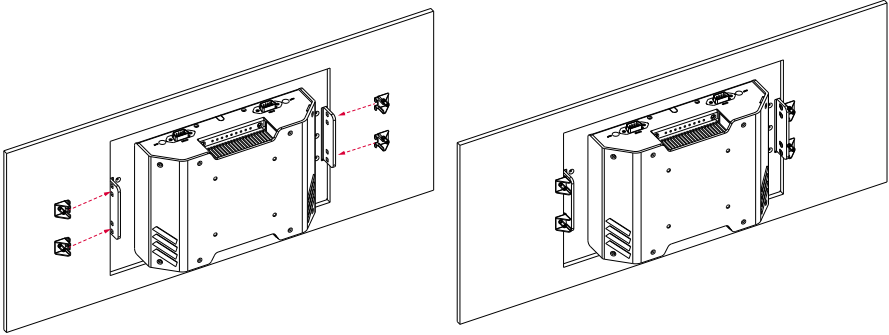

4.3.2. VESA Mounting

4.3.2.1. Use VESA Arm

To integrate the computer to a VESA arm:

1. Find the VESA mounting holes on the Panel PC. The VESA specifications varies according to your model.



2. Attach the VESA arm to the rear of the computer by meeting the mounting holes on the VESA arm and VESA bracket.
3. Fix the assemblage with four screws.

VESA compliant arm

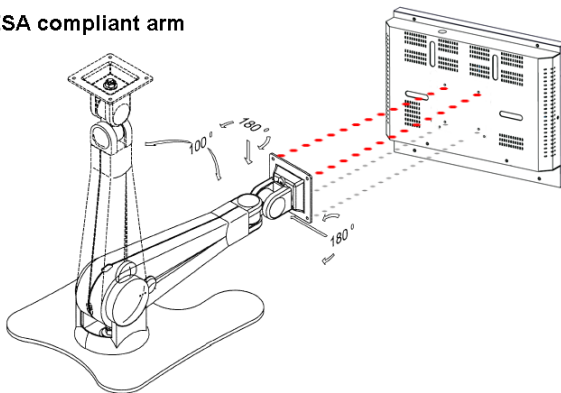

Chapter 5

BIOS

BIOS

The BIOS Setup utility for the ASLAN-W9XXC/917X is featured by American Megatrends Inc to configure the system settings stored in the system's BIOS ROM. The BIOS is activated once the computer powers on. When the computer is off, the battery on the main board supplies power to BIOS RAM.

To enter the BIOS Setup utility, keep hitting the “Delete” key upon powering on the computer.

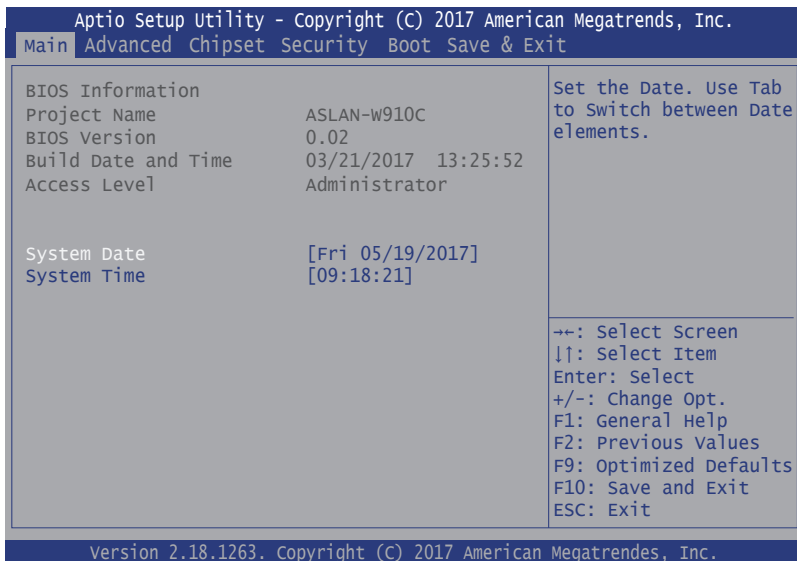

Menu	Description
Main	See 5.1. Main on page 78
Advanced	See 5.2. Advanced on page 79
Chipset	See 5.3. Chipset on page 92
Boot	See 5.4 Security on page 99
Security	See 5.5. Boot on page 100
Save & Exit	See 5.6. Save & Exit on page 101

Key Commands

The BIOS Setup utility relies on a keyboard to receive user's instructions. Hit the following keys to navigate within the utility and use the utility.

Keystroke	Function
← →	Moves left/right between the top menus.
↓ ↑	Moves up/down between highlight items.
Enter	Selects an highlighted item/field.
Esc	<ul style="list-style-type: none"> ▶ On the top menus: Use Esc to quit the utility without saving changes to CMOS. (The screen will prompt a message asking you to select OK or Cancel to exit discarding changes. ▶ On the submenus: Use Esc to quit current screen and return to the top menu.
Page Up / +	Increases current value to the next higher value or switches between available options.
Page Down / -	Decreases current value to the next lower value or switches between available options.
F1	Opens the Help of the BIOS Setup utility.
F10	Exits the utility saving the changes that have been made. (The screen then prompts a message asking you to select OK or Cancel to exit saving changes.)

Note: Pay attention to the "WARNING" that shows at the left pane onscreen when making any change to the BIOS settings.

This BIOS Setup utility is updated from time to time to improve system performance and hence the screenshots hereinafter may not fully comply with what you actually have onscreen.

5.1. Main

The **Main** menu features the settings of **System Date** and **System Time** and displays some BIOS info.

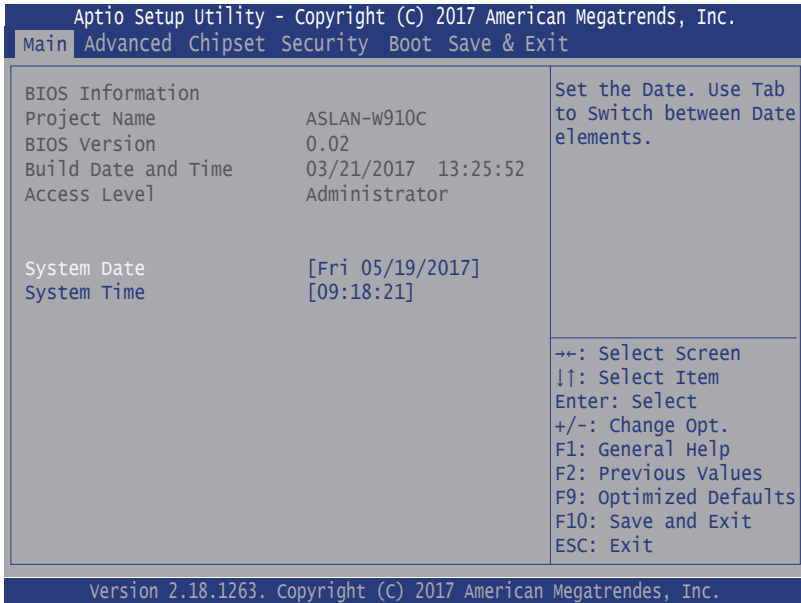

Setting	Description
Project Name	Delivers the model name of the computer.
BIOS Version	Delivers the computer's BIOS version.
Build Date and Time	Delivers the date and time when the BIOS Setup utility was made/ updated.
Access Level	Delivers the level that the BIOS is being accessed at the moment.
System Date	Sets system date.
System Time	Sets system time.

5.2. Advanced

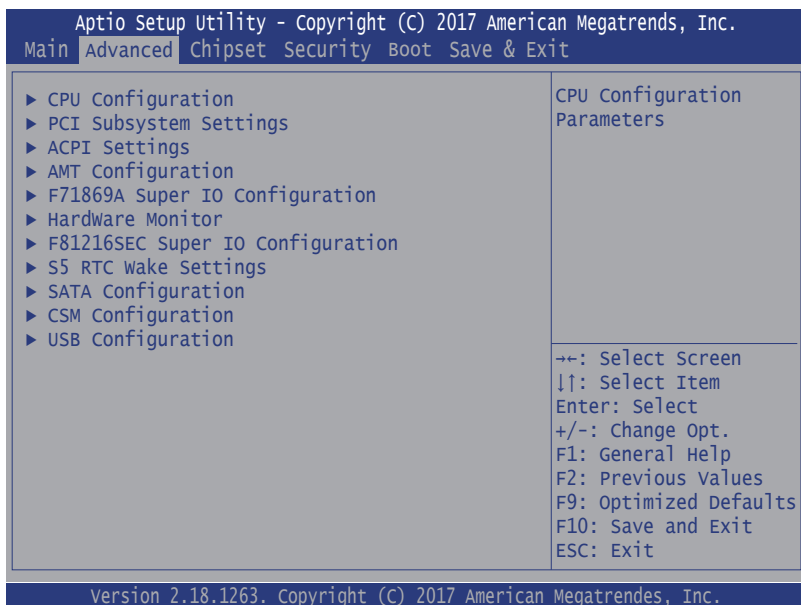

Setting	Description
CPU Configuration	See 5.2.1. CPU Configuration on page 80
PCI Subsystem Settings	See 5.2.2. PCI Sybssystem Settings on page 81
ACPI Settings	See 5.2.3. ACPI Settings on page 82
AMT Configuration	See 5.2.4. AMT Configuration on page 83
F71816A Super IO Configuration	See 5.2.5. F71869A Super IO Configuration on page 84 (Not available for ASLAN-W910/915)
Hardware Monitor	See 5.2.6. Hardware Monitor on page 85
F81216SEC Super IO Configuration	See 5.2.7. F81216SEC Super IO Configuration on page 86
S5 RTC Wake Settings	See 5.2.8. S5 RTC Wake Settings on page 87
SATA Configuration	See 5.2.9. SATA Configuration on page 88
CSM Configuration	See 5.2.10. CSM Configuration on page 89
USB Configuration	See 5.2.11. USB Configuration on page 90

5.2.1. CPU Configuration

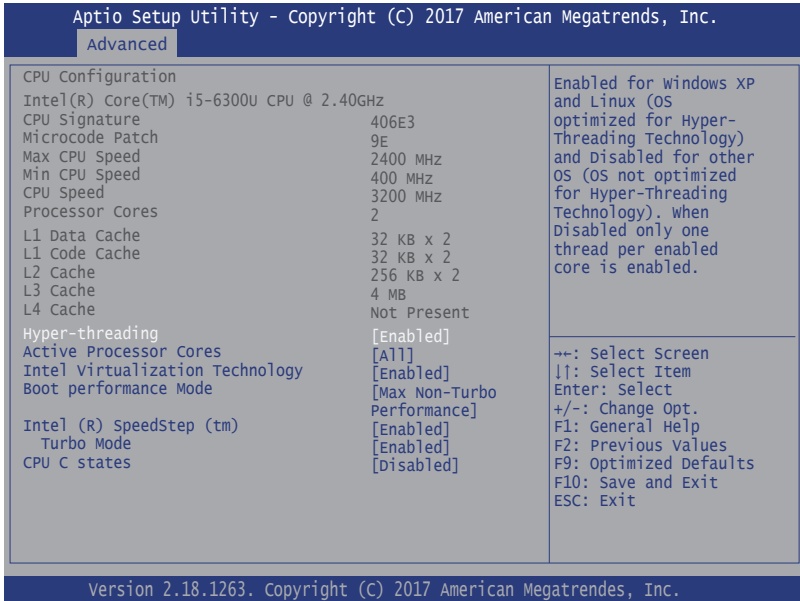

Setting	Description
Hyper-threading	Enabled (default) for Windows XP and Linux (OS optimized for Hyper-Threading Technology) and Disabled for other OS (OS not optimized or Hyper-Threading Technology). When disabled only one thread per enabled core is enabled.
Active Processor Cores	Number of cores to enable in each processor package. ► Options: All (default) and 1
Intel Virtualization Technology	When enabled, a VMM can utilize the additional hardware capabilities provided by Vanderpool Technology ► Options: Enabled (default) or Disabled
Boot performance Mode	Set the performance state that the BIOS will set before the OS handoff. ► Options: Max Battery , Max Non-Turbo Performance (default) and Turbo Performance .
Intel (R) Speed Step (tm)	Enable (default) / Disable Intel SpeedStep
Turbo Mode	Only available when Intel Speed Step is Enabled . Enable (default) / Disable Turbo Mode
CPU C States	Enable / Disable (default) CPU C States

5.2.2. PCI Sybsystem Settings

Aptio Setup Utility - Copyright (C) 2017 American Megatrends, Inc.

Advanced

PCI Bus Driver Version	A5.01.08	Enables or Disables 64bit capable Devices to be Decoded in Above 4G Address Space (Only if System Supports 64 bit PCI Decoding).
PCI Device Common Settings:		
PCI Latency Timer	[32 PCI Bus Clocks]	
PCI-X Latency Timer	[64 PCI Bus Clocks]	
Above 4G Decoding	[Disabled]	
		+=: Select Screen ↓↑: Select Item Enter: Select +/-: Change Opt. F1: General Help F2: Previous Values F9: Optimized Defaults F10: Save and Exit ESC: Exit

Version 2.18.1263. Copyright (C) 2017 American Megatrends, Inc.

Setting	Description
PCI Latency Timer	Value to be programmed into PCI Latency Timer Register. ► Options: 32 (default), 64, 96, 128, 160, 192, 224 and 248 PCI Bus Clocks.
PCI-X Latency Timer	Value to be programmed into PCI-X Latency Timer Register. ► Options: 32, 64 (default), 96, 128, 160, 192, 224 and 248 PCI Bus Clocks.
Above 4G Decoding	Enable/Disable (default) 64bit capable Devices to be Decoded in Above 4G Address Space (Only if System Supports 64 bit PCI Decoding).

5.2.3. ACPI Settings

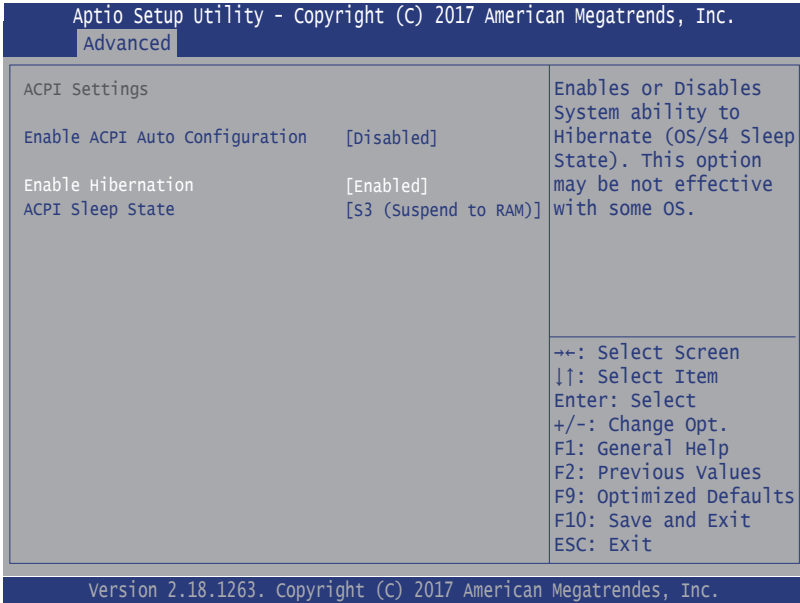

Setting	Description
Enable ACPI Auto Configuration	Enables or Disables (default) BIOS ACPI Auto Configuration
Enable Hibernation	Enables (default) or Disables System ability to Hibernate (OS/ S4 Sleep State). This option may be not effective with some OS.
ACPI Sleep State	Select ACPI sleep state the system will enter when the SUSPEND button is pressed. ► Options: Suspend Disabled and S3 (Suspend to RAM) (default)

5.2.4. AMT Configuration

Intel® Active Management Technology (Intel® AMT) is a hardware-based solution that uses out-of-band communication for system administrators to monitor and manage the computers and other network equipment by remote control even if the hard drive is crashed, the system is turned off or the operating system is locked. This submenu features the settings of iAMT's BIOS extension, which are required to make use of iAMT.

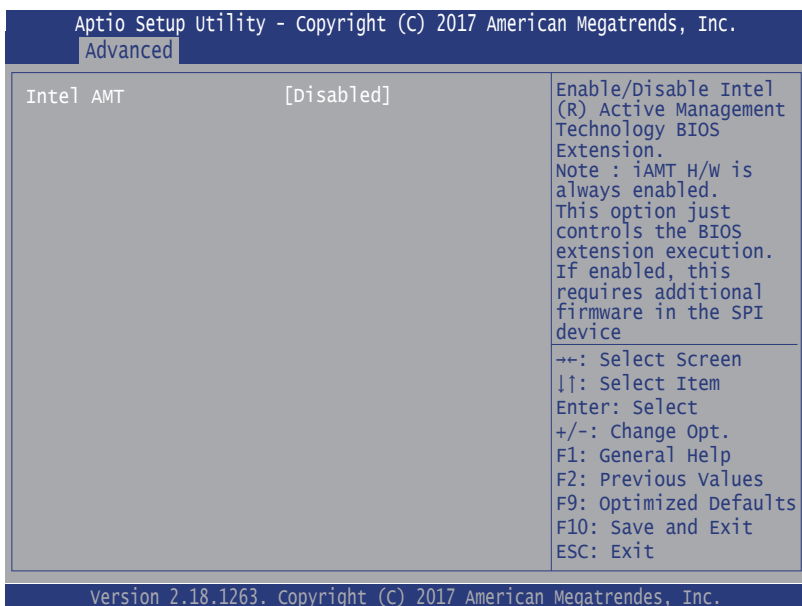

Setting	Description
Intel AMT	<p>Enables (default) /disables Intel® Active Management Technology BIOS extensions.</p> <ul style="list-style-type: none"> ▶ Note iAMT hardware is always enabled. ▶ This setting only controls the execution of BIOS extension execution. ▶ When enabled, additional firmware is required in the SPI device.

5.2.5. F71869A Super IO Configuration

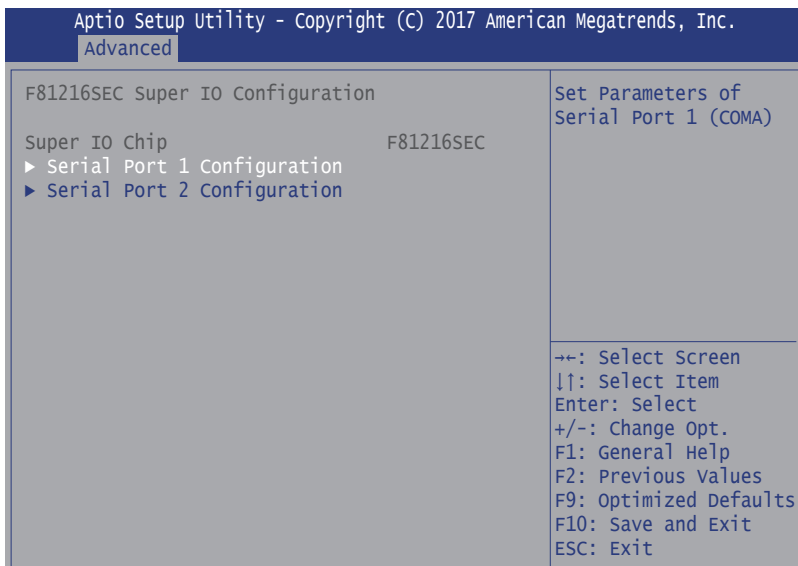

Note: This page is not available to ASLAN-W910/915.

Setting	Description
Serial Port	Enable (default) or Disable Serial Port (COM).
Change Settings	Select an optimal setting for Super IO device. <ul style="list-style-type: none"> ▶ Options for Serial Port 1: Auto; IO=3F8h; IRQ=4 (default) ; IO=3F8h; IRQ=3, 4, 5, 6, 7, 9, 10, 11, 12; IO=2F8h; IRQ=3, 4, 5, 6, 7, 9, 10, 11, 12; IO=3E8h; IRQ=3, 4, 5, 6, 7, 9, 10, 11, 12; IO=2E8h; IRQ=3, 4, 5, 6, 7, 9, 10, 11, 12; ▶ Options for Serial Port 2: Auto IO=2F8h; IRQ=3 (default) IO=3F8h; IRQ=3, 4, 5, 6, 7, 9, 10, 11, 12; IO=2F8h; IRQ=3, 4, 5, 6, 7, 9, 10, 11, 12; IO=3E8h; IRQ=3, 4, 5, 6, 7, 9, 10, 11, 12; IO=2E8h; IRQ=3, 4, 5, 6, 7, 9, 10, 11, 12
Mode Select	Select RS-232 (default), RS-422 or RS-485 .

5.2.6. Hardware Monitor

Select this submenu to view the main board's hardware status. Select it to run a report of various info as depicted below:

The screenshot displays the Aptio Setup Utility interface. At the top, it reads 'Aptio Setup Utility - Copyright (C) 2017 American Megatrends, Inc.' and 'Advanced'. The main content area is titled 'Pc Health Status' and lists the following hardware metrics:

CPU Temperature	: +52°C
System Temperature	: +52°C
Vcore	: +0.858 V
+5V	: +4.961 V
5VSB	: +4.918 V
3.3V	: +3.336 V

Below the metrics, a list of navigation and function keys is provided:

- +/: Select Screen
- ↓↑: Select Item
- Enter: Select
- +/-: Change Opt.
- F1: General Help
- F2: Previous Values
- F9: Optimized Defaults
- F10: Save and Exit
- ESC: Exit

At the bottom of the screen, it reads 'Version 2.18.1263. Copyright (C) 2017 American Megatrends, Inc.'

5.2.7. F81216SEC Super IO Configuration

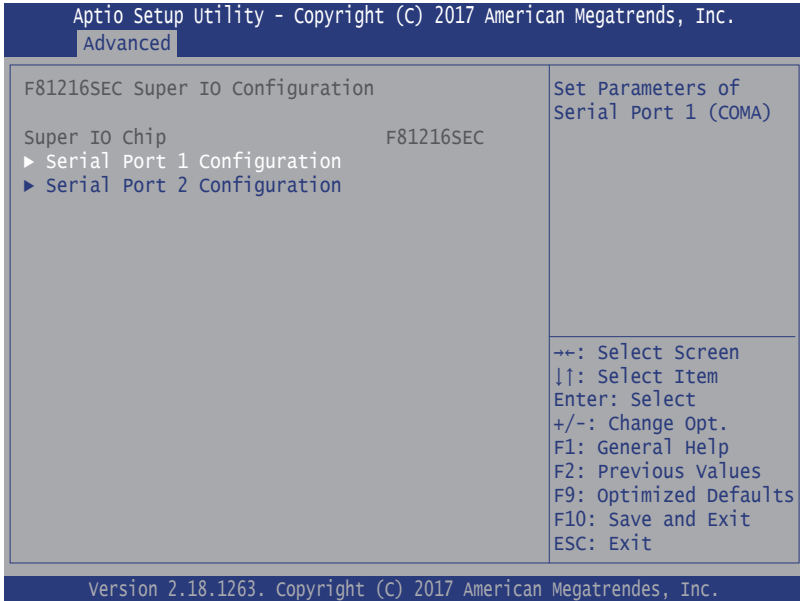

Setting	Description
Serial Port	Enable (default) or Disable Serial Port (COM).
Change Settings	Select an optimal setting for Super IO device. <ul style="list-style-type: none"> ▶ Options for Serial Port 1: Auto; IO=240h; IRQ=5 (default) ; IO=240h; IRQ=3, 4, 5, 6, 7, 9, 10, 11, 12; IO=248h; IRQ=3, 4, 5, 6, 7, 9, 10, 11, 12; IO=250h; IRQ=3, 4, 5, 6, 7, 9, 10, 11, 12; IO=258h; IRQ=3, 4, 5, 6, 7, 9, 10, 11, 12; ▶ Options for Serial Port 2: Auto IO=248h; IRQ=7 (default) ; IO=240h; IRQ=3, 4, 5, 6, 7, 9, 10, 11, 12; IO=248h; IRQ=3, 4, 5, 6, 7, 9, 10, 11, 12; IO=250h; IRQ=3, 4, 5, 6, 7, 9, 10, 11, 12; IO=258h; IRQ=3, 4, 5, 6, 7, 9, 10, 11, 12;
Mode Select	Select RS-232 (default), RS-422 or RS-485 .

5.2.8. S5 RTC Wake Settings

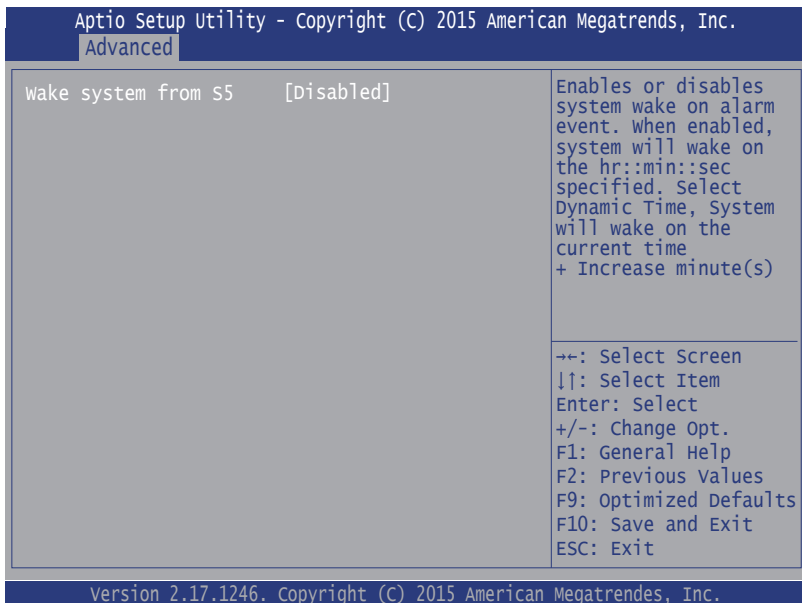

Setting	Description
Wake System from S5	<p>Enable or Disable (default) system wake on alarm event.</p> <p>► Options available are:</p> <p>Disabled (default):</p> <p>Fixed Time: System will wake on the hr::min::sec specified.</p> <p>DynamicTime: If selected, you need to set Wake up minute increase from 1 - 5. System will wake on the current time + increase minute(s).</p>

5.2.9. SATA Configuration

Aptio Setup Utility - Copyright (C) 2017 American Megatrends, Inc.

Advanced

SATA Controller(s)	[Enabled]	Enable or disable SATA Device.
SATA Mode Selection	[AHCI]	
Serial ATA Port 0	mSATA-I50 (64.0GB)	→←: Select Screen ↓ ↑: Select Item Enter: Select +/-: Change Opt. F1: General Help F2: Previous Values F9: Optimized Defaults F10: Save & Exit ESC: Exit
Software Preserve	Supported	
Port 0	[Enabled]	
Device Sleep	[Disabled]	
SATA DEVSLEP Idle Timeout Config	[Disabled]	
Serial ATA Port 1	Empty	
Software Preserve	Unknown	
Port 0	[Enabled]	
Device Sleep	[Disabled]	
SATA DEVSLEP Idle Timeout Config	[Disabled]	
Serial ATA Port 2	Empty	
Software Preserve	Unknown	
Port 0	[Enabled]	
Device Sleep	[Disabled]	
SATA DEVSLEP Idle Timeout Config	[Disabled]	

Version 2.18.1263. Copyright (C) 2017 American Megatrends, Inc.

Setting	Description
SATA Controller(s)	Enables (default) / disables SATA device(s).
SATA Mode Selection	Configures how SATA controller(s) operate. ▶ Options: AHCI (default) and RAID .
Serial ATA Port 0 ,1 ,2	SATA device information
Port 0, 1, 2	Enables (default) / disables the SATA port 0, 1, 2.
Device Sleep	Enables / disables (default) the mSATA for RTD3.
SATA DEVSLEP Idle Timeout Config	Enables / disables (default) SATA DTIO config.

5.2.10. CSM Configuration

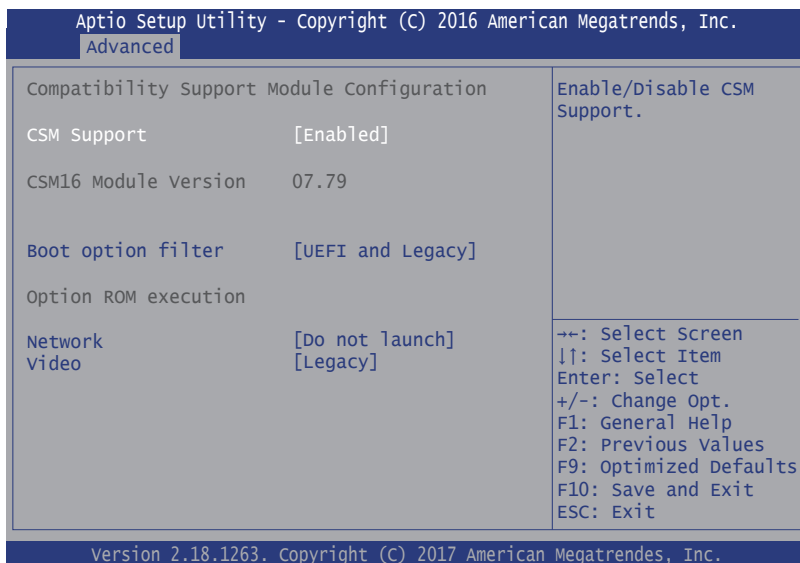

Setting	Description
CSM Support	Enable (default) or Disable CSM Support.
Boot option filter	Control the Legacy/UEFI ROMs priority. ▶ Options: UEFI and Legacy (default), Legacy only , UEFI only
Network	Control the execution of UEFI and Legacy PXE OpROM ▶ Options: Do not launch (default) and Legacy
Video	Control the execution of UEFI and Legacy Video OpROM ▶ Options: UEFI and Legacy (default)

5.2.11. USB Configuration

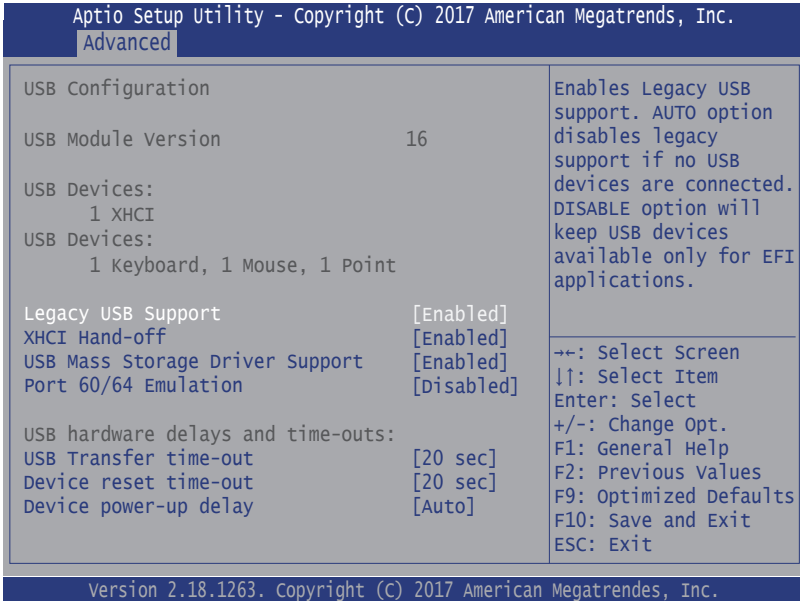

Setting	Description
Legacy USB Support	<p>Enables/disables legacy USB support.</p> <ul style="list-style-type: none"> ▶ Options available are Enabled (default), Disabled and Auto. ▶ Select Auto to disable legacy support if no USB device are connected. ▶ Select Disabled to keep USB devices available only for EFI applications.
XHCI Hand-off	<p>This is a workaround for OSeS without XHCI hand-off support. The XHCI ownership change should be claimed by XHCI driver.</p> <ul style="list-style-type: none"> ▶ The optional settings are: Enabled (default) / Disabled.
USB Mass Storage Driver Support	<p>Enables/disables USB Mass Storage Driver Support.</p> <ul style="list-style-type: none"> ▶ The optional settings are: Disabled / Enabled (default).
USB hardware delay and time-out	
Port 60/64 Emulation	Enables / Disables (default) I/O port 60/64h emulation support.
USB Transfer time-out	<p>Use this item to set the time-out value for control, bulk, and interrupt transfers.</p> <ul style="list-style-type: none"> ▶ Options: 1 sec, 5 sec, 10 sec, 20 sec

Device reset time-out	Use this item to set USB mass storage device start unit command time-out. ▶ Options available are: 10 sec, 20 sec (default), 30 sec, 40 sec
Device power-up delay	Use this item to set maximum time the device will take before it properly reports itself to the host controller. 'Auto' uses default value: for a root port it is 100 ms, for a hub port the delay is taken from hub descriptor. ▶ Options available are: Auto: Default Manual: Select Manual you can set value for the following sub-item: 'Device Power-up delay in seconds', the delay range in from 1 to 40 seconds, in one second increments.

5.3. Chipset

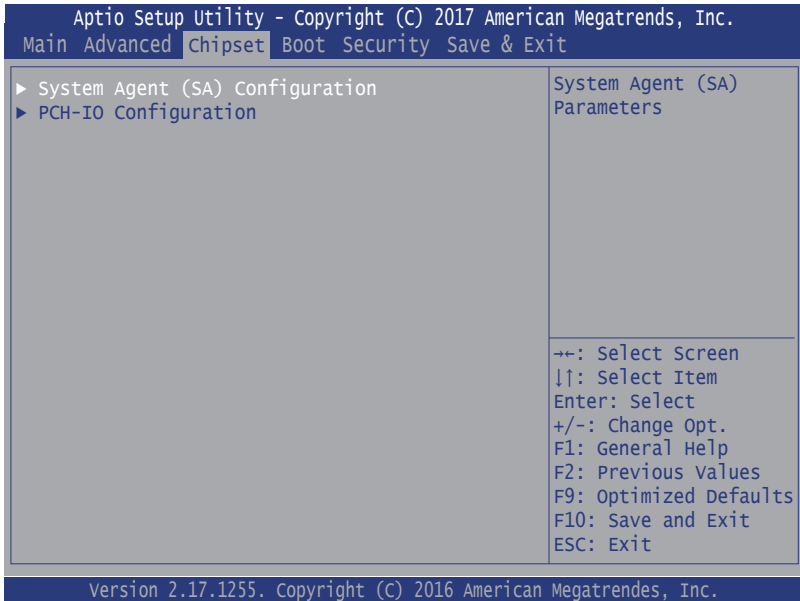

Submenu	Description
System Agent (SA) Configuration	See 5.3.1. System Agent (SA) Configuration on page 93
PCH-IO Configuration	See 5.3.2. PCH-IO Configuration on page 96

5.3.1. System Agent (SA) Configuration

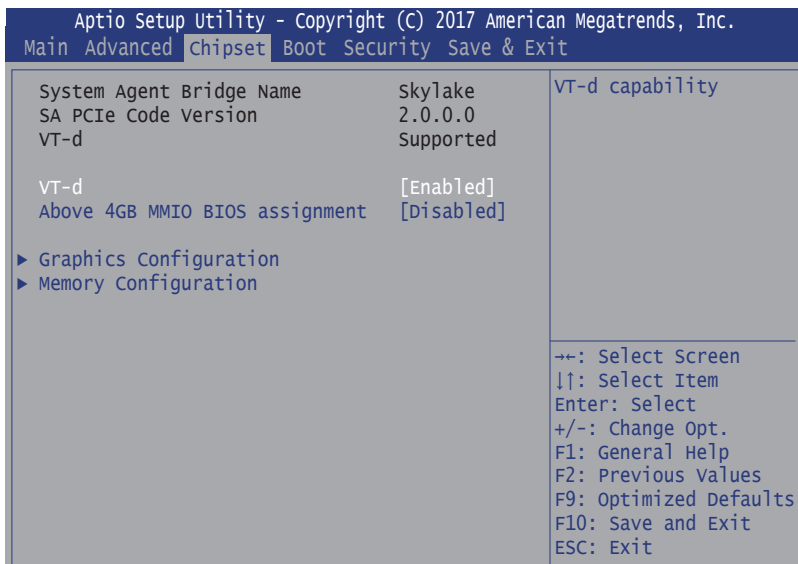

Submenu	Description
VT-d	Enable (default) or Disable VT-d function
Above 4GB MMIO BIOS assignment	Enable or Disable (default) Above 4GB MMIO BIOS assignment
System Agent (SA) Configuration	
Graphics Configuration	See 5.3.1.1. Graphics Configuration on page 94
Memory Configuration	See 5.3.1.2. Memory Configuration on page 95

5.3.1.1. Graphics Configuration

Setting	Description
IGFX VBIOS Version	Display the IGFX(internal VGA) VBIOS version.
Graphics Turbo IMON Current	Sets the graphics turbo IMON current values. ▶ Options available are 14 to 31 . 31 is the default.
Skip scanning of External Gfx Card	If enabled, it will not scan for External Gfx Card on PEG and PCH PCIE ports.
Primary Display	Select the Graphics device which will be activated as Primary Display. ▶ Options available are Auto (default), IGFX and PCIE
Primary PEG	Select the Graphics device which will be activated as Primary PEG ▶ Options available are Auto (default), PEG11 , and PEG12 .
Primary PCIE	Select the Graphics device which will be activated as Primary PCIE ▶ Options available are Auto (default), PCIE1~18 .
Internal Graphics	Enables/disables the IGD. ▶ Options available are Auto (default), Disabled , and Enabled .
GTT Size	Select the GTT Size. ▶ Options: 4MB , 2MB and 8MB (default).
Aperture Size	Select the Aperture Size. Note that above 4GB MMIO BIOS assignment is automatically enabled when selecting 2048MB aperture. To use this feature, please disable CSM support. ▶ Options: 128MB , 256MB (default), 512MB , 1024MB , 2048MB and 4096MB .
DVMT Pre-Allocated	Select the DVMT 5.0 Pre-allocated (Fixed) Graphic Memory size used by the Internal Graphic Device. ▶ 32M is the default.
DVMT total Gfx Mem	Select the DVMT 5.0 Total Graphic Memory size used by the Internal Graphic Device. ▶ Options: 128MB , 256MB (default) and Max .

5.3.1.2. Memory Configuration

Access this submenu to view the memory configuration.

The screenshot shows the Aptio Setup Utility interface. At the top, it reads "Aptio Setup Utility - Copyright (C) 2017 American Megatrends, Inc." Below this, the "Chipset" submenu is selected. The main area displays "Memory Information" with the following details:

Memory RC Version	1.9.0.0
Memory Frequency	2133 Mhz
Total Memory	8192 MB
VDD	1200
DIMM#0	Not Present
DIMM#1	8192 MB
Memory Timings (tCL-tRCD-tRP-tRAS)	15-36

Below the memory information, a list of navigation keys is provided:

- +/: Select Screen
- ↓↑: Select Item
- Enter: Select
- +/-: Change Opt.
- F1: General Help
- F2: Previous Values
- F9: Optimized Defaults
- F10: Save and Exit
- ESC: Exit

At the bottom of the screen, it reads "Version 2.18.1263. Copyright (C) 2017 American Megatrends, Inc."

5.3.2. PCH-IO Configuration

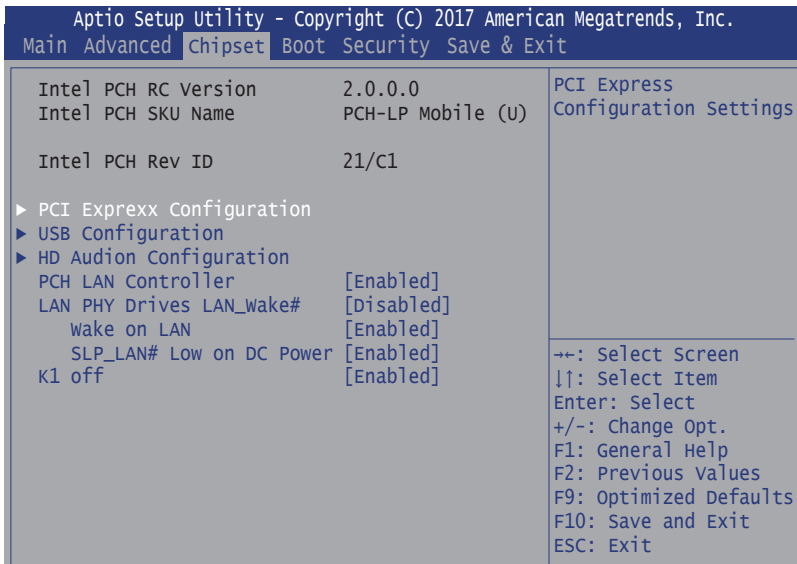

Setting	Description
PCI Express Configuration	See 5.3.2.1. PCI Express Configuration on page 98
USB Configuration	See 5.3.2.2. USB Configuration on page 98
HD Audio Configuration	<ul style="list-style-type: none"> ▶ Control Detection of the HD-Audio device. Options available are: Disabled: HDA will be unconditionally disabled Enabled: HDA will be unconditionally Enabled Auto (default) = HDA will be enabled if present, disabled otherwise. ▶ USB Audio Device Enable (default) or disable USB Audio Device.
PCH LAN Controller	Enabled (default) / disabled onboard NIC. If enabled, "Wake on LAN" option will be available to enable (default) / disable integrated LAN to wake the system. (The Wake On LAN cannot be disabled if ME is on at Sx state.)

LAN PHY Drives LAN-WAKE#	Enable or disable (default) LAN Phy driving LAN-WAKE# else platform drives LAN_WAKE#. <ul style="list-style-type: none">▶ Wake on LAN Enable (default) or disable integrated LAN to wake the system. (The Wake On LAN cannot be disabled if ME is on at Sx state)/▶ SLP_LAN# Low on DC Power Enable (default) or disable SLP_LAN# Low on DC Power
K1 Off	Enable (default) or disable K1 off feature (CLKREQ).

5.3.2.1. PCI Express Configuration

Setting	Description
PCI Express Root Port 1/2/3/4/5/6/10	Enable (default) or disable PCI Express Port.
ASPM Support	Disable or set the ASPM level. Force L0s will force all links to L0s state. "Auto" will allow BIOS to auto configure."Disable" will disable ASPM. ▶ Options: Disabled (default), L0s , L1 , L0sL1 and Auto .
L1 Substates	PCI Express L1 Substates settings. ▶ Options: Disabled , L1.1 , L1.2 and L1.1 & L1.2 (default).
PCIe Speed	Select PCI Express port speed. ▶ Options: Auto (default), Gen1 , Gen2 and Gen3

5.3.2.2. USB Configuration

Setting	Description
USB Precondition	Precondition work on USB host controller and root ports for faster enumeration. ▶ Options: Enable/Disable (default).
XHCI Disable Compliance Mode	Options to disable Compliance Mode. Default is FALSE (default) to not disable Compliance Mode. Set TRUE to disable Compliance Mode.
xDCI Support	Enable/disable (default) xDCI (USB OTG Device).
USB Port Disable Override	Selectively enable/disable (default) the corresponding USB port from reporting a Device Connection to the controller.

5.4 Security

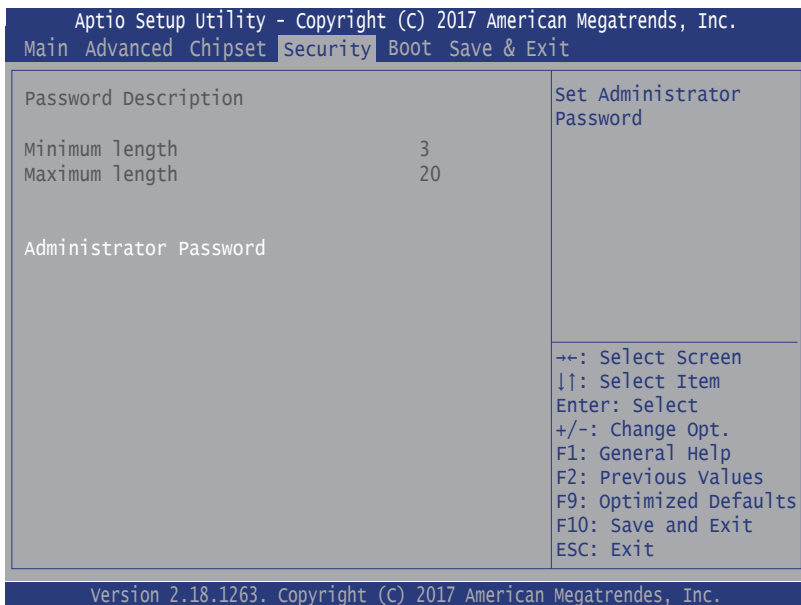

Setting	Description
Administrator Password	<p>To set up an administrator password:</p> <ol style="list-style-type: none"> 1. Select Administrator Password. 2. An Create New Password dialog then pops up onscreen. 3. Enter your desired password that is no less than 3 characters and no more than 20 characters. 4. Hit [Enter] key to submit.

5.5. Boot

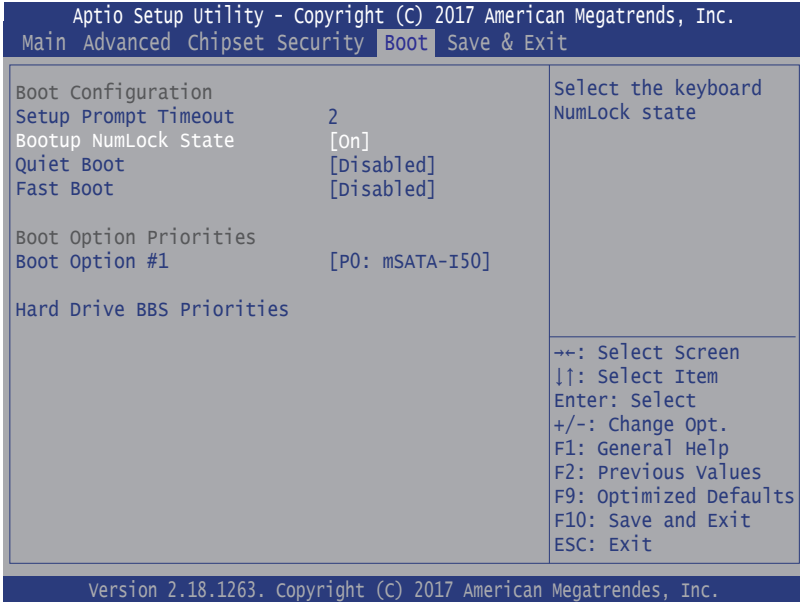

Setting	Description
Setup Prompt Timeout	Set how long to wait for the prompt to show for entering BIOS Setup. <ul style="list-style-type: none"> ▶ The default setting is 2 (sec). ▶ Set it to 65535 to wait indefinitely.
Bootup NumLock State	Sets whether to enable or disable the keyboard's NumLock state when the system starts up. <ul style="list-style-type: none"> ▶ Options available are On (default) and Off.
Quiet Boot	Sets whether to display the POST (Power-on Self Tests) messages or the system manufacturer's full screen logo during booting. <ul style="list-style-type: none"> ▶ Select Disabled to display the normal POST message, which is the default.
Fast Boot	Enables or disables (default) boot with initialization of a minimal set of devices required to launch active boot option. Has no effect for BBS boot options.
Boot Option Priority	Set the system boot priorities.
Hard Drive BBS Priorities	Sets the order of the legacy devices in this group. BBS means "BIOS Boot Specification".

5.6. Save & Exit

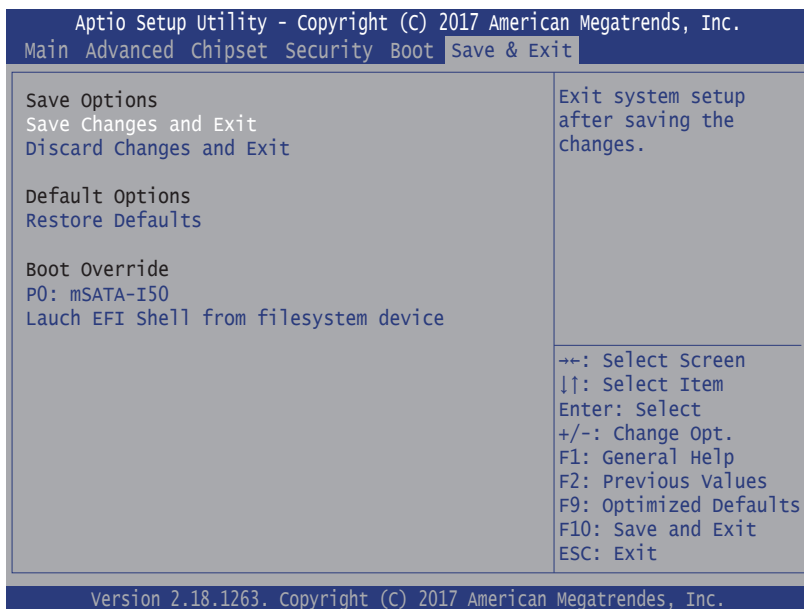

Setting	Description
Save Changes and Reset	Saves the changes and quits the BIOS Setup utility.
Discard Changes and Exit	Quits the BIOS Setup utility without saving the change(s).
Restore Defaults	Restores all settings to defaults. <ul style="list-style-type: none"> ▶ This is a command to launch an action from the BIOS Setup utility.
Boot Override	Boot Override presents a list in context with the boot devices in the system. <ul style="list-style-type: none"> ▶ P0: mSATA-I50: Select the device to boot up the system regardless of the currently configured boot priority. ▶ Launch EFI Shell from filesystem device: Attempts to launch EFI Shell Application (Shell.efi) from one of the available filesystem devices.