FPC-810X Series

FPC-8108W-G1

FPC-8109-G1

**Robust Box PC with Intel® 10th Generation
Core™ i9/i7/i5/i3 Processor**

User's Manual

Version 1.0



This page is intentionally left blank.

Revision History

Version	Release Time	Description
1.0	2022.01	Initial release

Revision History	i
Contents	ii
Preface.....	v
Copyright Notice.....	v
Declaration of Conformity.....	v
CE	v
FCC Class A.....	v
RoHS.....	vi
SVHC / REACH.....	vi
Important Safety Instructions	vii
Warning.....	viii
Replacing Lithium Battery	viii
Technical Support.....	viii
Warranty.....	ix
Chapter 1 - Introduction.....	1
1.1. The Computer	2
1.2. About this Manual.....	2
1.3. Specifications	3
1.4. Inside the Package.....	6
1.5.1. Optional Accessories.....	6
1.5.2. Configure-to-Order Service.....	6
Chapter 2 - System Overview.....	8
2.1. Dimensions	9
2.2. Take A Tour.....	10
2.2.1. FPC-8108W-G1 / FPC-8109-G1	10
2.3. Driver Installation Notes.....	12
Chapter 3 - System Configuration	13
3.1. Board Layout.....	14
3.2. Jumpers and Connectors	18
3.2.1. Jumpers	18
3.2.2. Connectors.....	19
Chapter 4 - Installation and Maintenance.....	33
4.1. Install Hardware	34
4.1.1. Open the Computer.....	34
4.1.2. Install CPU	37
4.1.3. Install/Uninstall Memory Modules	40
4.1.4. Install Wi-Fi Module.....	44
4.1.5. Install/uninstall SIM Card	48
4.1.6. Install SATA Storage Devices.....	51
4.1.7. Install PCI and PCI Express Cards	53

4.1.8. Install/uninstall CFast Card	53
4.1.9. Install graphic cards (For FPC-8108W-G1).....	55
4.1.10. Install graphic cards (For FPC-8109-G1).....	57
4.1.11. Install/uninstall SIM Card.....	59
4.2. Ground the Computer	61
4.3. Wire DC-in Power Source.....	61
4.3.1 Automation Mode	61
4.3.2 Vehicle Application Mode	62
Chapter 5 - BIOS	65
5.1. Main	68
5.2. Advanced	69
5.2.1. CPU Configuration	70
5.2.2. Trusted Computing.....	72
5.2.3. ACPI Settings.....	73
5.2.4. Super IO Configuration	74
5.2.5. Hardware Monitor.....	77
5.2.6. S5 RTC Wake Settings	78
5.2.7 AMI Graphic Output Protocol policy	79
5.2.8. PCI Sybssystem Settings	80
5.2.9. USB Configuration	81
5.2.10. CSM Configuration (For FPC-8108W-G1)	83
5.2.10. CSM Configuration (For FPC-8109-G1).....	84
5.2.11. NVMe Configuration.....	85
5.3. Chipset.....	86
5.4. Security	92
5.4.1. Security Boot.....	93
5.5. Boot.....	94
5.6. Save & Exit.....	96
Appendices	97
A: Digital I/O Setting.....	98
B: Watchdog Timer (WDT) Setting.....	101

This page is intentionally left blank.

Copyright Notice

All Rights Reserved.

The information in this document is subject to change without prior notice in order to improve the reliability, design and function. It does not represent a commitment on the part of the manufacturer.

Under no circumstances will the manufacturer be liable for any direct, indirect, special, incidental, or consequential damages arising from the use or inability to use the product or documentation, even if advised of the possibility of such damages.

This document contains proprietary information protected by copyright. All rights are reserved. No part of this document may be reproduced by any mechanical, electronic, or other means in any form without prior written permission of the manufacturer.

Declaration of Conformity

CE

The CE symbol on the computer indicates that it is in compliance with the directives of the Union European (EU). A Certificate of Compliance is available by contacting Technical Support.

This product has passed the CE test for environmental specifications when shielded cables are used for external wiring. We recommend the use of shielded cables. This kind of cable is available from ARBOR. Please contact your local supplier for ordering information.

Warning

This is a class A product. In a domestic environment this product may cause radio interference in which case the user may be required to take adequate measures.

FCC Class A

This device complies with Part 15 of the FCC Rules. Operation is subject to the following two conditions:

- (1) This device may not cause harmful interference, and
- (2) This device must accept any interference received, including interference that may cause undesired operation.

Preface

NOTE:

This equipment has been tested and found to comply with the limits for a Class A digital device, pursuant to Part 15 of the FCC Rules. These limits are designed to provide reasonable protection against harmful interference when the equipment is operated in a commercial environment. This equipment generates, uses, and can radiate radio frequency energy and, if not installed and used in accordance with the instruction manual, may cause harmful interference to radio communications. Operation of this equipment in a residential area is likely to cause harmful interference in which case the user will be required to correct the interference at his own expense.

RoHS

ARBOR Technology Corp. certifies that all components in its products are in compliance and conform to the European Union's Restriction of Use of Hazardous Substances in Electrical and Electronic Equipment (RoHS) Directive 2002/95/EC.

The above mentioned directive was published on 2/13/2003. The main purpose of the directive is to prohibit the use of lead, mercury, cadmium, hexavalent chromium, polybrominated biphenyls (PBB), and polybrominated diphenyl ethers (PBDE) in electrical and electronic products. Member states of the EU are to enforce by 7/1/2006.

ARBOR Technology Corp. hereby states that the listed products do not contain unintentional additions of lead, mercury, hex chrome, PBB or PBDB that exceed a maximum concentration value of 0.1% by weight or for cadmium exceed 0.01% by weight, per homogenous material. Homogenous material is defined as a substance or mixture of substances with uniform composition (such as solders, resins, plating, etc.). Lead-free solder is used for all terminations (Sn(96-96.5%), Ag(3.0-3.5%) and Cu(0.5%)).

SVHC / REACH

To minimize the environmental impact and take more responsibility to the earth we live, Arbor hereby confirms all products comply with the restriction of SVHC (Substances of Very High Concern) in (EC) 1907/2006 (REACH --Registration, Evaluation, Authorization, and Restriction of Chemicals) regulated by the European Union.

All substances listed in SVHC < 0.1 % by weight (1000 ppm)

Important Safety Instructions

Read these safety instructions carefully

1. Read all cautions and warnings on the equipment.
2. Place this equipment on a reliable surface when installing. Dropping it or letting it fall may cause damage
3. Make sure the correct voltage is connected to the equipment.
4. For pluggable equipment, the socket outlet should be near the equipment and should be easily accessible.
5. Keep this equipment away from humidity.
6. The openings on the enclosure are for air convection and protect the equipment from overheating. **DO NOT COVER THE OPENINGS.**
7. Position the power cord so that people cannot step on it. Do not place anything over the power cord.
8. Never pour any liquid into opening. This may cause fire or electrical shock.
9. Never open the equipment. For safety reasons, the equipment should be opened only by qualified service personnel.
10. If one of the following situations arises, get the equipment checked by service personnel:
 - a. The power cord or plug is damaged.
 - b. Liquid has penetrated into the equipment.
 - c. The equipment has been exposed to moisture.
 - d. The equipment does not work well, or you cannot get it to work according to the user's manual.
 - e. The equipment has been dropped or damaged.
 - f. The equipment has obvious signs of breakage.
11. Keep this User's Manual for later reference.

Warning

The Box PC and its components contain very delicately Integrated Circuits (IC). To protect the Box PC and its components against damage caused by static electricity, you should always follow the precautions below when handling it:

1. Disconnect your Box PC from the power source when you want to work on the inside.
2. Use a grounded wrist strap when handling computer components.
3. Place components on a grounded antistatic pad or on the bag that came with the Box PC, whenever components are separated from the system.

Replacing Lithium Battery

Incorrect replacement of the lithium battery may lead to a risk of explosion.

The lithium battery must be replaced with an identical battery or a battery type recommended by the manufacturer.

Do not throw lithium batteries into the trash can. It must be disposed of in accordance with local regulations concerning special waste.

Technical Support

If you have any technical difficulties, please consult the user's manual first at:
<http://www.arbor-technology.com>

Please do not hesitate to e-mail our customer service when you still cannot find out the answer.

E-mail: info@arbor.com.tw

Warranty

This product is warranted to be in good working order for a period of one year from the date of purchase. Should this product fail to be in good working order at any time during this period, we will, at our option, replace or repair it at no additional charge except as set forth in the following terms. This warranty does not apply to products damaged by misuse, modifications, accident or disaster.

Vendor assumes no liability for any damages, lost profits, lost savings or any other incidental or consequential damage resulting from the use, misuse of, or inability to use this product. Vendor will not be liable for any claim made by any other related party.

Vendors disclaim all other warranties, either expressed or implied, including but not limited to implied warranties of merchantability and fitness for a particular purpose, with respect to the hardware, the accompanying product's manual(s) and written materials, and any accompanying hardware. This limited warranty gives you specific legal rights.

Return authorization must be obtained from the vendor before returned merchandise will be accepted. Authorization can be obtained by calling or faxing the vendor and requesting a Return Merchandise Authorization (RMA) number. Returned goods should always be accompanied by a clear problem description.

This page is intentionally left blank.

Chapter 1

Introduction

1.1. The Computer

- Supports NVIDIA® GTX-16 series up to 150W GPU
- Wide range DC power input (9~36V)
- Two independent displays support (HDMI x1 + VGA x 1 and DVI-D x 1)
- Power on/off delay control / configurable ignition power control
- TPM2.0 support
- 1 x mPCIe for optional WiFi/3G/4G/GPS or I/O expansion supported
- 1 x M.2 E Key (2230) for WiFi/BT
- 1 x M.2 (NGFF) B-Key(2242/3052/2280) socket for storage or 5G / LTE(**FPC-8108W-G1**)
- Up to 5x expansion slot support(**FPC-8109-G1**)
- 1 x 2.5 Gigabit LAN support
- Front-accessible I/O support

1.2. About this Manual

This manual is meant for the experienced users and integrators with hardware knowledge of personal computers. If you are not sure about the description herein, consult your vendor before further handling.

We recommend that you keep one copy of this manual for the quick reference for any necessary maintenance in the future. Thank you for choosing ARBOR products.

1.3. Specifications

System	
CPU	Intel® 10 th generation Core™ i9/i7/i5/i3 processor in LGA1200 socket
Memory	2 x 260-pin DDR4 SO-DIMM sockets, supporting 2933 MHz SDRAM up to 64GB
Chipset	Intel® H420E (FPC-8108W-G1) / W480E (FPC-8109-G1)
Graphics	Integrated Intel® HD Graphics
ATA	2 x Serial ATA ports with 600MB/s HDD transfer rate
LAN Chipset	1 x Intel® WGI225LM 2.5GigE LAN 1 x Intel® WGI211AT GbE controllers 1 x Intel® WGI219LM GbE controller (w/o iAMT, H420E) (w/ iAMT, W480E)
Watchdog Timer	1~255 levels reset
I/O	
Serial Port	2 x RS-232/422/485 configurable via DB-9 connectors
	4 x RS-232 ports via DB-9 connectors
USB Port	6 x USB 3.2 Gen1 / 2.0 ports
	2 x USB 2.0 ports
	Internal USB dongle (Optional)
LAN	3 x RJ-45 ports for GbE
Video Port	1 x HDMI
	1 x DB-15 female connector for Analog RGB
	1 x DVI-D female connector for digital video output
	*Support 2 independent displays *Support 3 independent displays (W480E, only)
Selectable Port	1 x DB25 connector for DIO (8 in/8 out) port or LPT port (either one, default is DIO)
Audio	Mic-in/Line-out

Introduction

Expansion Bus	1 full-size Mini-card interconnected with SIM card for optional WiFi/3G/4G/GPS or I/O Expansion (PCIe x 1+USB2.0)
	1 x SIM socket
	1 x M.2 E key (2230) with PCIe1+USB2.0, for Wireless
	1 x M.2 B key (2242/3052/2280) w/ (PCIe2+USB3.0+SATA) interconnected with SIM for 5G / LTE expansion or for storage (either one) (FPC-8108W-G1)
	3 x PCIe x 4 slot 1 x PCIe x16 slot (via x8 lanes) Support up to 150W GPU (FPC-8108W-G1)
Environmental	4 x PCI 1 x PCIe x16 slot Support up to 150W GPU (FPC-8109-G1)
	Operating Temp.
	-20 ~ 70°C (-4 ~ 158°F), ambient w/ air flow, (w/ 35W TDP CPU, fanless) -20 ~ 55°C (-4 ~ 131°F), ambient w/ air flow (w/ 65W TDP CPU, fanless) -20~45°C (-4 ~ 112°F), w/ GTX-1660 GPU
Storage Temp.	-40 ~ 85°C (-40 ~ 185°F)
Operating Humidity	10 ~ 95% @ 70°C (non-condensing)
Vibration	3 Grms/5~500Hz/random operation w/ SSD
Shock	Operating 40G (11ms), Non-operating 60G with SSD
Qualification	
Certification	CE, FCC Class A
Power Requirement	
Power Input	DC 9~36V input Max. 16A/300W (w/ 4-pin DC input terminal block, combining remote power on/off switch)
Ignition Switch	2-pin terminal block: IGN, GND
Power Consumption	MAX 65W (w/35W TDP CPU, w/o I/O card) MAX 95W (w/65W TDP CPU, w/o I/O card)
Storage	
Type	2 x 2.5" drive bays
	1 x CFAST socket, can be outside accessible
Mechanical	
Construction	Aluminum alloy
Mounting	Wall-mount

Weight	7.35kg (16.20lb)
Dimensions (W x H x D)	225 x 292 x 190mm (8.86" x 11.50" x 5.51")
OS Support	
Windows 10 IOT Enterprise 64-bit Linux (Kernel:4.9)	
Ordering Information	
FPC-8109-G1	Ruggedized Edge AI computing Box PC with Intel® 10th Gen Core™ i9/i7/i5/i3 w/ expansion fan and PEG 8-pin power cable Supporting NVIDIA® 150W GPU
FPC-8109-G1	Robust Box PC with Intel® 10th Gen Core™ i9/i7/i5/i3 w/ expansion fan and PEG 8-pin power cable Supporting NVIDIA® 150W GPU

1.4. Inside the Package

Upon opening the package, carefully inspect the contents. If any of the items is missing or appears damaged, contact your local dealer or distributor. The package should contain the following items:





1 x FPC-8108W-G1/
FPC-8109-G1
Robust System



1 x User's Manual







1.5.1. Optional Accessories

The following items are normally optional, but some vendors may include them as a standard package, or some vendors may not carry all the items.

WMK-7000	Wall-mount kit for FPC-7XXX Series	
PAC-120W6B-FSP	120W AC/DC adapter kit w/ 2-pin/3-pin/4-pin block	
PAC-180W6C-FSP	180W AC/DC adapter kit w/ 2-pin/3-pin/4-pin block	
PAC-280W6C-MW	280W AC/DC 24V adapter kit w/ 2-pin/3-pin/4-pin block	

1.5.2. Configure-to-Order Service

Make the computer more tailored to your needs by selecting one or more components from the list below to be fabricated to the computer.

240GB SSD	Intel® 2.5" 240GB SATAIII SSD kit	
WIFI-IN2550	Intel AX200NGW M.2 Wi-Fi 6 module w/ 2 x 30cm internal wires	
ANT-H11	1 x 2dBi HSUPA antenna	
ANT-D11	1 x WiFi dual-band 2.4G/5G antenna	
Core™ i9-10900E	Intel® 10th Gen. Core™ i9-10900E processor, L2/20M, 2.8G	
Core™ i9-10900TE	Intel® 10th Gen. Core™ i9-10900TE processor, L2/20M, 1.8G	
Core™ i7-10700E	Intel® 10th Gen. Core™ i7-10700E processor, L2/16M, 2.9G	
Core™ i7-10700TE	Intel® 10th Gen. Core™ i7-10700TE processor, L2/16M, 2.0G	
Core™ i5-10500E	Intel® 10th Gen. Core™ i5-10500E processor, L2/12M, 3.1G	
Core™ i5-10500TE	Intel® 10th Gen. Core™ i5-10500TE processor, L2/12M, 2.3G	
Core™ i3-10100E	Intel® 10th Gen. Core™ i3-10100E processor, L2/6M, 3.1G	
Core™ i3-10100TE	Intel® 10th Gen. Core™ i3-10100TE processor, L2/6M, 2.3G	
MK-4C-4G/8G/16G/32G	DDR4-2400 4GB/8GB/16GB/32G(2933) SDRAM DIMM kit	
MK-4I-4G/8G/16G/32G	WT, DDR4-2400 4GB/8GB/16GB/32G(DDR4-2933) SDRAM DIMM kit	

Chapter 2

System Overview

2.1. Dimensions

FPC-8108W-G1 / FPC-8109-G1

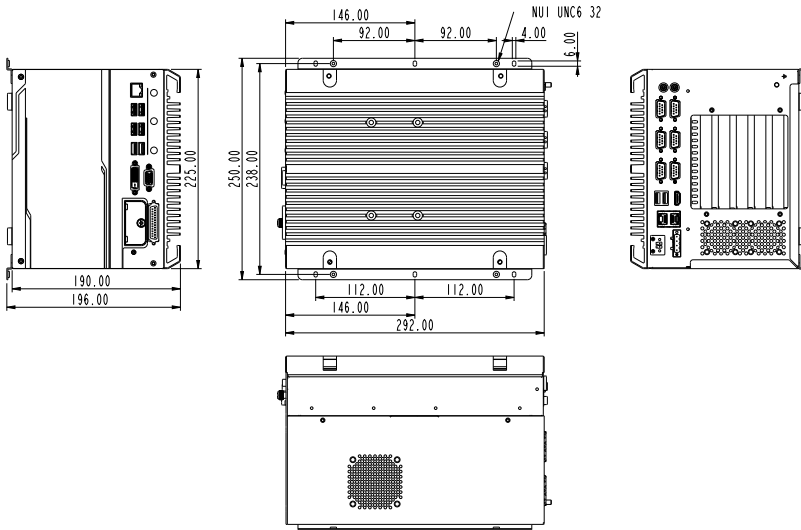

System Overview

2.2. Take A Tour

2.2.1. FPC-8108W-G1 / FPC-8109-G1

2.2.1.1 Front View

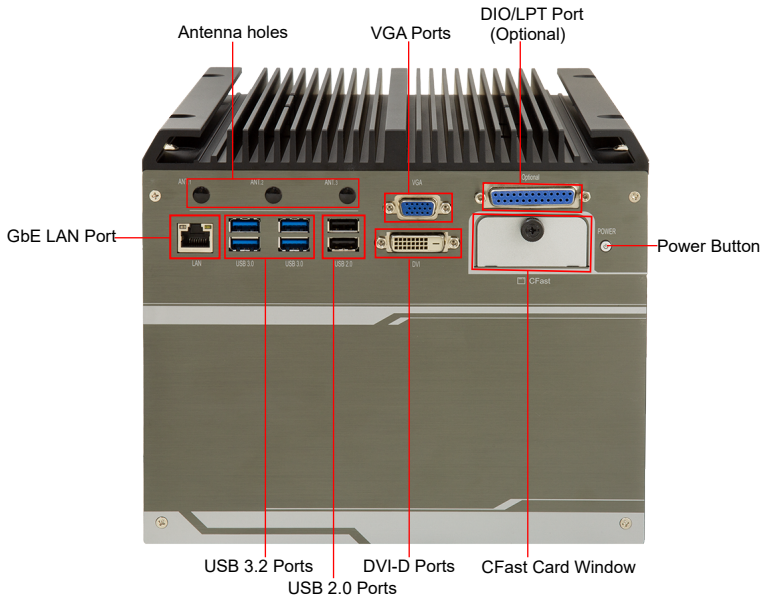

2.2.1.2 Rear View

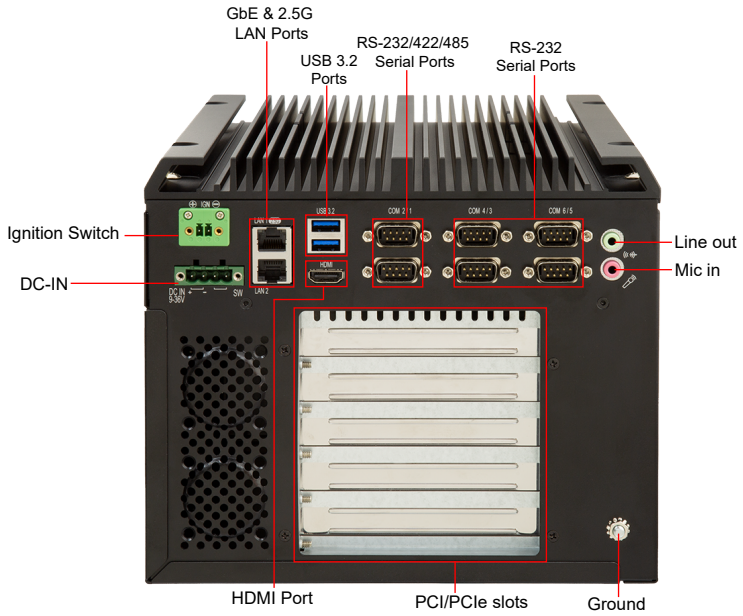

2.3. Driver Installation Notes

The CPU module supports Windows 10 64-bit and Linux. To install the drivers, please go to our website at www.arbor-technology.com and download the driver pack from the product page. Then extract the downloaded file and follow the sequence below to install the drivers:

Chipset → **Graphic** → **Audio** → **Other drivers**

The driver path is listed as below:

Windows 10

Driver	Path
Chipset	\\WIN10\Chipset\10.1.1.42\SetupChipset.exe
LAN	\\WIN10\Ethernet\PROWinx64.exe
VGA	\\WIN10\Graphics\Setup.exe
Audio	\\WIN10\AUDIO\0006-64bit_Win7_Win8_Win81_Win10_R279.exe
ME	\\WIN10\ME_11.6\SetupME.exe

Chapter 3

System Configuration

3.1. Board Layout

Board Top

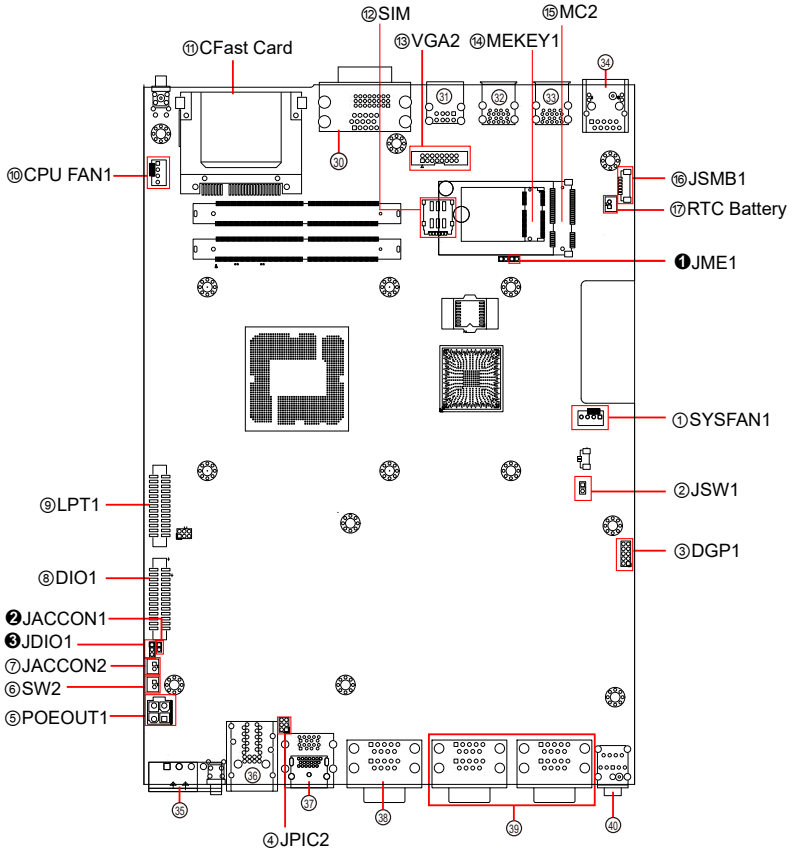

Board Bottom

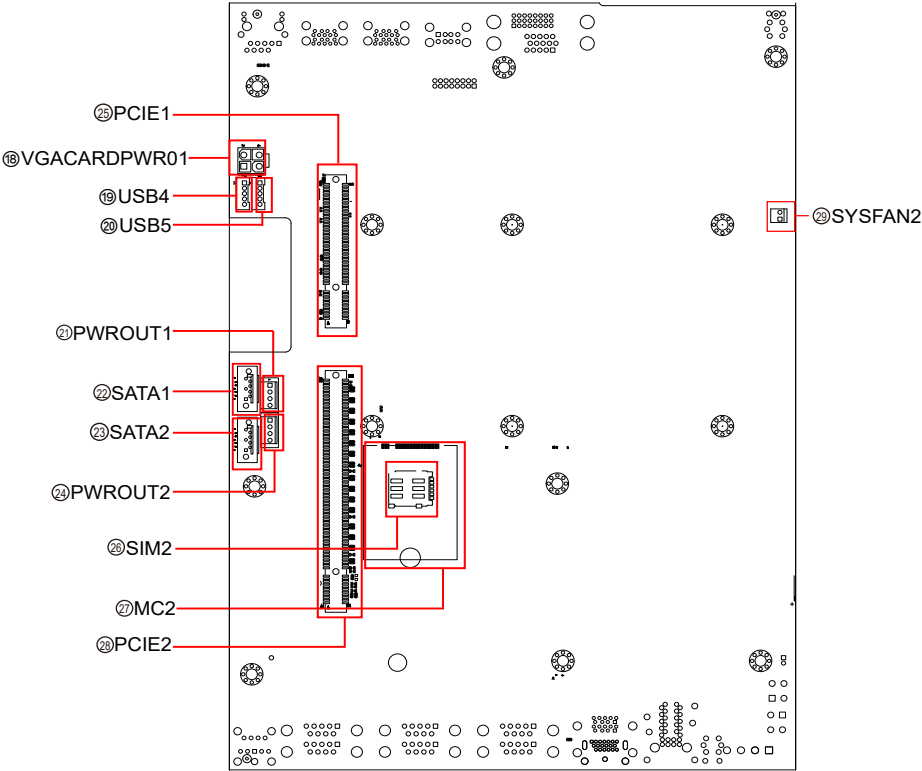

Engine of the Computer

Jumpers

Label	Description
① JME1	Clear CMOS selection
② JACCON1	ACC ON Mode selection
③ JDIO1	Ignition power mode

Connectors

Label	Description
① SYSFAN1	Fan power connector
② JSW1	System reset pin header
③ DGP1	External 80 port pin header
④ JPIC2	Vcore IC debug pin header
⑤ POEOUT1	PoE power connector
⑥ SW2	System switch
⑦ JACCON2	Ignition Power connector
⑧ DIO1	Digital IO Connector
⑨ LPT1	On-board parallel port connector
⑩ CPUFAN1	Fan power connector
⑪ CF1	CFast Card type slot
⑫ SIM	Nano SIM card socket
⑬ VGA2	Analog RGB
⑭ MEKEY1	M.2 E-Key socket
⑮ MC2	PCI Express Mini-card socket
⑯ JSMB1	SMbus wafer connector
⑰ RTC Battery	RTC Battery
⑱ VGACARDPWR1	Power output for VGA card
⑲ ⑳ USB4,5	USB wafer connector
㉑ ㉒ PWROUT1,2	SATA HDD power connector
㉓ ㉔ SATA1, SATA2	Serial ATA connector
㉕ PCIE1	PCI Expansion Slot



②⑥	SIM2	Nano SIM card socket		
②⑦	MC2	PCI Express Mini-card socket		
②⑧	PCIE2	PCI Expansion Slot		
②⑨	SYSFAN2	Fan power connector		
③①	VGA1	Analog RGB & DVI-D Connector		
③①	③②	③③	USB1, 2, 3	USB 2.0/3.0 connectors
③④	LAN1	RJ-45 Ethernet connector		
③⑤	PWRIN3	DC Adapter Power Input		
③⑥	LAN2	Dual GbE RJ-45 Ethernet connectors		
③⑦	HDMISUB1	HDMI + USB Connector		
③⑧	COM1/2	RS-232/422/485 Selectable Serial Port		
③⑨	COM3/4, 5/6	RS-232		
④①	Audio1	Audio connector		

3.2. Jumpers and Connectors

3.2.1. Jumpers



❶ JME1

Function: Clear CMOS Selection
Jumper Type: 2.00mm pitch, 1x2-pin header
Setting:

Pin	Description	
Short 1-2	Clear CMOS	
Open 1-2	Keep CMOS (default)	



❷ JACCON1

Function: ACC ON Mode selection(for debug)
Jumper Type: 2.00mm pitch, 1x2-pin header
Setting:

Pin	Description	
Short 1-2	ACC ON Mode	
Open 1-2	Car mode	

❸ JDIO

Function: Digital I/O VCC out put voltage
Jumper Type: Onboard 2.00mm-pitch 1x3-pin header
Setting:

Pin	Description	
Short 1-2 12V		
Short 2-3 5V (default)		

3.2.2. Connectors

① ⑩ FAN Connector (SYSFAN1/CPUFAN1)

Function: Fan Power Connector

Connector Type: Onboard 2.54mm pitch 1x4-pin one-wall wafer connector

Pin Assignment:

Pin	Description
1	GND
2	+12V
3	RPM
4	Control



② System reset pin header (JSW1)

Function: Reserved for Reset button

Connector Type: onboard 2.0mm pitch 2-pin header

Pin Assignment:

Pin	Description
1	FR_RST#
2	GND



③ DGP1

Function: External 80 port

Connector Type: 2.00mm-pitch 2x5-pin header

Pin Assignment:

Pin	Description	Pin	Description
1	CLK	2	GND
3	FRAME#	4	LAD0
5	PLTRST#	6	N.C
7	LAD3	8	LAD2
9	VCC3	10	LAD1

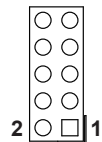

④ Vcore IC debug pin header (JPIC2)

Function Reserved For Vcore IC debug
Connector Type: Onboard 2.0mm pitch 6-pin header
Pin Assignment:

Pin	Description	Pin	Description
1	NC	2	NC
3	GND	4	PMSCL
5	nPMALERT	6	PMSDA



⑤ POEOUT1

Function: PoE Power Connector
Connector Type: 2.54mm-pitch 4-pin header
Pin Assignment:

Pin	Desc.
1	GND
2	GND
3	DCIN
4	DCIN

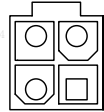

⑥ SW2

Function Power Button
Connector Type: Onboard 2x1-pin box connector
Pin Assignment:

Pin	Description
1	PWR_IN_SW#
2	GND

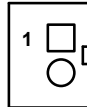

⑦ JACCON2

Function: Ignition Power Connector

Connector Type: Onboard 2x1-pin box connector

Pin Assignment:

Pin	Description
1	Acc_ON
2	GND

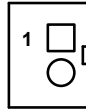

⑧ DIO1

Function: Digital IO Connector

Connector Type: 2.0mm pitch 2x13 pin box header

Pin Assignment:

Pin	Desc.	Pin	Desc
1	DIO0	14	DIO8
2	DIO1	15	DIO9
3	DIO2	16	DIO10
4	DIO3	17	DIO11
5	DIO4	18	DIO12
6	DIO5	19	DIO13
7	DIO6	20	DIO14
8	DIO7	21	DIO15
9	+5V	22	GND
10	+5V	23	GND
11	N.C	24	N.C
12	N.C	25	N.C
13	N.C	26	N.C

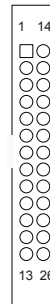

⑨ LPT1

Function: On-board Parallel Port Connector
Connector Type: 2.00mm pitch 2 x13-pin box header
Pin Assignment:

Pin	Desc.	Pin	Desc.
1	STB#	14	AFD#
2	PD0	15	ERR#
3	PD1	16	INIT#
4	PD2	17	SLIN#
5	PD3	18	GND
6	PD4	19	GND
7	PD5	20	GND
8	PD6	21	GND
9	PD7	22	GND
10	ACK#	23	GND
11	BUSY	24	GND
12	PE	25	GND
13	SLCT	26	N.C



⑩ CF1

Function: CFast Card Type I/II slot
Connector Type: 7+17-pin CFast Card connector consisting of a SATA compatible 7-pin signal connector and a 17-pin power and control connector.

Pin Assignment:

Pin	Desc.	Pin	Desc.
S1	SGND1	PC6	TBD
S2	TXP	PC7	GND
S3	TXN	PC8	LED1
S4	SGND2	PC9	LED2
S5	RXN	PC10	IO1
S6	RXP	PC11	IO2
S7	SGND	PC12	IO3
PC1	CDI	PC13	3.3V
PC2	GND	PC14	3.3V
PC3	TBD	PC15	GND
PC4	TBD	PC16	GND
PC5	TBD	PC17	CD0

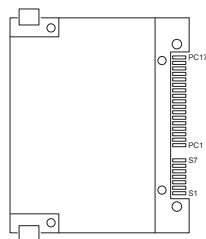

⑫ SIM

Function: SIM Card Socket
Connector Type: 6-pin SIM card socket
Pin Assignment:

Pin	Desc.	Pin	Desc.
C1	VCC	C2	RST
C3	CLK	C5	GND
C6	VPP	C7	I/O

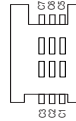

⑬ VGA2

Function: Analog RGB
Connector Type: Analog RGB(D-Sub 15-pin female type)
Pin Assignment:

Pin	Desc.	Pin	Desc.
1	RED	9	+5V
2	GREEN	10	GND
3	BLUE	11	N/C
4	N/C	12	VDDAT
5	GND	13	HSYNC
6	GND	14	VSYNC
7	GND	15	VDCLK
8	GND		

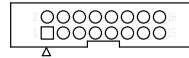

⑭ MEKEY1

Function: M.2 E-Key socket (w/ PCIe + USB 2.0) for optional Wi-Fi/BT
Connector Type: M.2 E-Key 2230 Socket
Pin Assignment: The pin assignments conform to the industry standard.

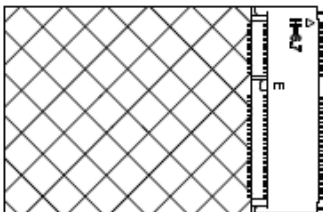

⑮ MC2

Function: PCI Express Mini-card Full socked
Connector Type: Onboard 0.8mm pitch 52-pin edge card connector.
Pin Assignment:

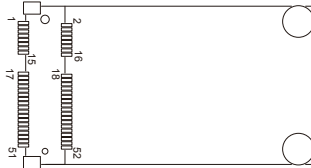

⑯ SMBUS Connector(JSMB1)

Function: SMBus Wafer connector for DIO
Connector Type: 1.25mm pitch 1x6 wafer connector
Pin Assignment:

Pin	Desc.
1	+V3.3S
2	GND
3	CLK
4	GND
5	DATA
6	+V12S



⑰ BAT1

Function: RTC Battery
Connector Type: Onboard 2x1-pin box connector
Pin Assignment:

Pin	Desc.
1	BAT+
2	BAT-



⑱ VGACARDPWR1

Function: VGA card power
Connector Type: onboard 2.54mm pitch 4-pin wafer
Pin Assignment:

Pin	Desc.
1	GND
2	GND
3	+V12S
4	+V12S

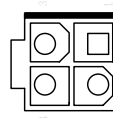

⑲ ⑳ USB4, 5

Function: USB 3.0/2.0 Connectors
Connector Type: On-board 1.25mm pitch 1x5 pin wafer connector
Pin Assignment:

Pin	Description.
1	+5V
2	D-
3	D+
4	GND
5	GND



㉑ ㉒ PWRROUT1, 2

Function: SATA HDD Power Connector
Connector Type: 2.54mm pitch 1x4-pin one-wall connector
Pin Assignment:

Pin	Description
1	+5V
2	GND
3	GND
4	+12V



②② ②③ SATA1, 2

Function: Serial ATA Connector
Connector Type: On-board Standard 7-pin Serial ATA Connector

Pin Assignment:

Pin	Description
1	GND
2	TX+
3	TX-
4	GND
5	RX-
6	RX+
7	GND

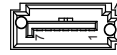

②⑤ PCIE1

Function: PCIe x 8 slot
Pin Assignment: This pin define is for ARBOR's riser board only

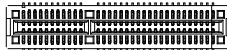

②⑥ SIM2 (for FPC-8108W-G1)

Function: SIM Card Socket
Connector Type: 6-pin SIM card socket
Pin Assignment:

Pin	Desc.	Pin	Desc
C1	VCC	C2	RST
C3	CLK	C5	GND
C6	VPP	C7	I/O

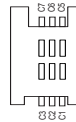

②⑦ MBKEY1 (for FPC-8108W-G1)

Function: M.2 B-Key socket (w/ PCIe + USB 3.0 or SATA + USB 3.0)(either one)

Connector Type: M.2 E-Key
Pin Assignment: The pin assignments conform to the industry standard.

②⑧ PCIE2

Function: PCIe x16 slot

Pin Assignment: This pin define is for ARBOR's riser board only.



②⑨ SYSFAN2

Function: System Fan power out

Connector Type: 2.0mm-pitch 2-pin header

Pin Assignment:

Pin	Description
1	+12V
2	GND



③⑩ VGA1

Function: Analog RGB & DVI-D Connector

Connector Type: Analog RGB (D-Sub 15-pin female type)
+ DVI-D (DVI-D female connector)

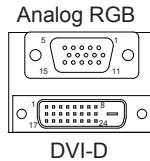

Pin Assignment:

Analog RGB Connector

Pin	Desc.	Pin	Desc.	Pin	Desc.
1	RED	6	GND	11	N/C
2	GREEN	7	GND	12	VDDAT
3	BLUE	8	GND	13	HSYNC
4	N/C	9	+5V	14	VSYNC
5	GND	10	GND	15	VDCLK

DVI-D Connector

Pin	Desc.	Pin	Desc.	Pin	Desc.
1	TMDS Data 2-	9	TMDS Data 1-	17	TMDS Data 0-
2	TMDS Data 2+	10	TMDS Data 1+	18	TMDS Data 0+
3	GND	11	GND	19	GND
4	NC	12	NC	20	NC
5	NC	13	NC	21	NC
6	DDC clock	14	+5V	22	GND
7	DDC data	15	GND	23	TMDS clock+
8	NC	16	Hot plug detect	24	TMDS clock-

①②③ USB1, 2, 3

Function: USB 2.0/3.0 connectors
Connector Type: USB2.0/3.0 Type-A connectors
Pin Assignment: The Pin assignment conform to the industry standard.

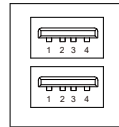

④ LAN1

Function: RJ-45 Ethernet connector
Connector Type: RJ-45 connector that supports 10/100/1000Mbps fast Ethernet
Pin Assignment: The Pin assignment conform to the industry standard.



⑤ PWRIN3

Function: DC Adapter Power Input
Connector Type: 4-pin Terminal block

Pin Assignment:

Pin	Desc.
1	VIN+
2	VIN-
3	Switch -
4	Switch +

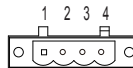

③⑥ LAN2

Function: Dual GbE RJ-45 Ethernet connectors
Connector Type: RJ-45 connector that supports 10/100/1000Mbps fast Ethernet
Pin Assignment: The Pin assignment conform to the industry standard.

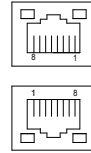

③⑦ HDMIUSB1

Function: HDMI Connectors (includes USB Connectors)
Connector Type: HDMI + double stacked USB type A connector
Pin Assignment: The Pin assignment conform to the industry standard.

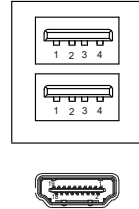

③⑧ COM1 (Panel label: COM1/2)

Function: RS-232/422/485 Selectable Serial Port
Connector Type: External double-stacked 9-pin D-sub male connector
Pin Assignment:

	Pin	Desc.	Pin	Desc.
RS-232	1	DCD	6	DSR
	2	RXD	7	RTS
	3	TXD	8	CTS
	4	DTR	9	RI
	5	GND		
RS-422	1	COM_422 TX-		
	1	COM_422 TX+		
	2	COM_422 RX+		
	3	COM_422 RX-		
RS-485	4	GND		
	1	COM_485 D-		
	2	COM_485 D+		
	5	GND		

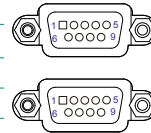

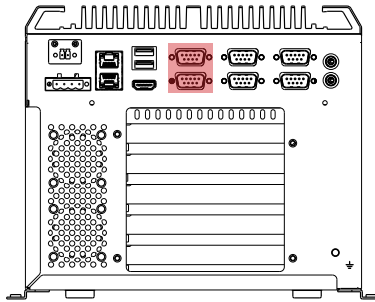

③⑨ **COM2,3 (Panel label: COM3/4, COM5/6)**

Function: RS-232 Serial Port

Connector Type: External double-stacked 9-pin D-sub male connector

Pin Assignment:

Pin	Description	Pin	Description
1	DCD	6	DSR
2	RXD	7	RTS
3	TXD	8	CTS
4	DTR	9	RI
5	GND		

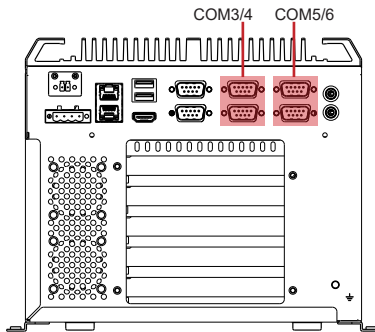
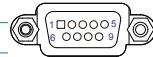
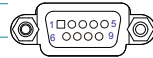



④⑩ **Audio1**

Function: Audio connector

Connector Type: Double-stacked ø3.5mm stereo audio jacks

Pin Assignment:

Description	
Line-out	 Line out
Mic-in	 Mic

3.2.2.2 Riser board

Board Top

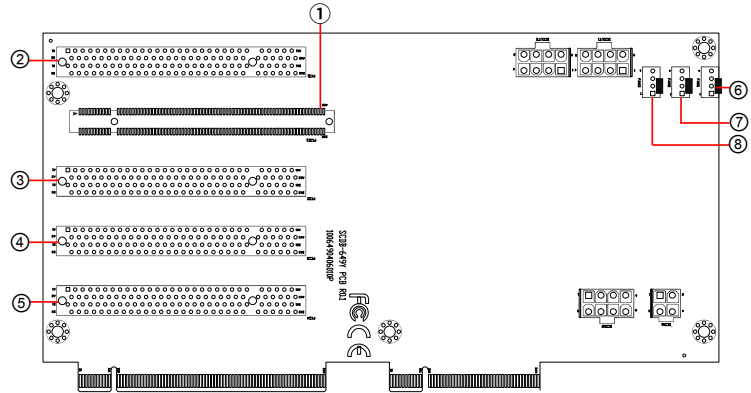

Board Bottom

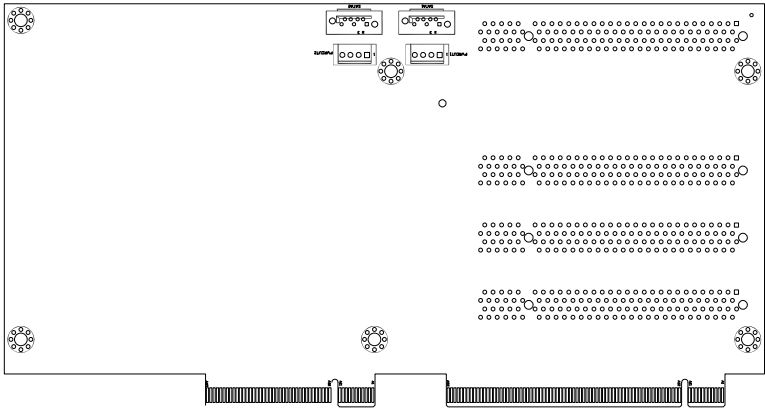

Engine of the Computer

① PCIE1

Function: PCIe x16 slot

Pin Assignment: The pin assignments conform to the industry standard.



②③④⑤ PCI

Function: PCI slot

Pin Assignment: The pin assignments conform to the industry standard.



⑥⑦⑧ FAN1-3

Function: Fan Power Connector

Connector Type: Onboard 2.54mm pitch 1x4-pin one-wall wafer connector.

Pin Assignment:

Pin	Pin Description
-----	-----------------

1	GND
---	-----

2	+12V
---	------

3	RPM
---	-----

4	Control
---	---------



Please note that the rest of the connectors and pins on the SCDB-649Y R01 are for other computers.

Chapter 4

Installation and Maintenance

4.1. Install Hardware

The FPC-810X Series is constructed based on modular design to make it easy for users to add hardware or to maintain the computer. The following sections will guide you to the simple hardware installations for the computer.

4.1.1. Open the Computer

For the computer, removing the top and bottom covers is essential to open the computer and access the inside. Follow through the steps below to remove the top cover and bottom cover from the computer.

4.1.1.2. Remove Top Cover

All jumpers, CPU socket, MiniCard socket, SDRAM SO-DIMM slots, DIO/ LPT ports are built on the top side of the main board. To access these components, the computer's top cover has to be removed. Follow through the steps below to remove the top cover.

1. Place the computer on a flat surface. Loosen and remove the 8 screws as shown below.



2. Carefully lift the top cover and then completely part the top cover from the computer.



The inside of the computer comes to view.



4.1.1.3. Remove the Side and Bottom Cover

The Serial ATA connectors, the power connectors for SATA storage devices, and the internal USB ports, PCI/PCIe slots are all built on the bottom side of the main board. To access these connectors, the computer's bottom cover has to be removed. Follow through the steps below to remove the bottom cover from the computer.

1. Place the computer upside down on a flat surface. Loosen and remove the 5 screws on the bottom side as shown below.

Installation & Maintenance

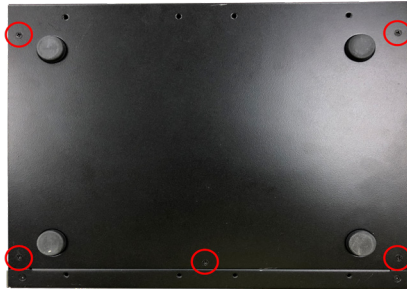

2. Place the computer on a flat surface. Loosen and remove 2 screws on the side cover as shown below.

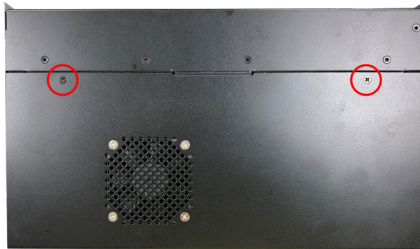

3. After removing all screws, carefully lift and remove the bottom and side cover from the computer.



Note: Please note that a fan cable is on the bottom and side cover when removing it.

The bottom of the computer comes to view.



4.1.2. Install CPU

1. Remove the top cover from the computer as described in [4.1.1.2. Remove Top Cover on page 34.](#)
2. Locate the CPU socket on the main board

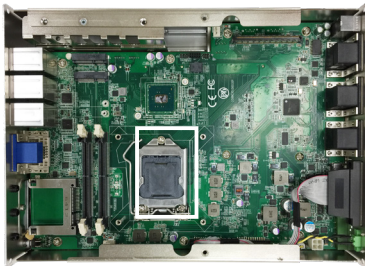

The processor socket comes with a lever to secure the processor. Please refer to the pictures step by step as below and note that the cover of the socket must always be installed during transportation to avoid damage to the socket.

Installation & Maintenance

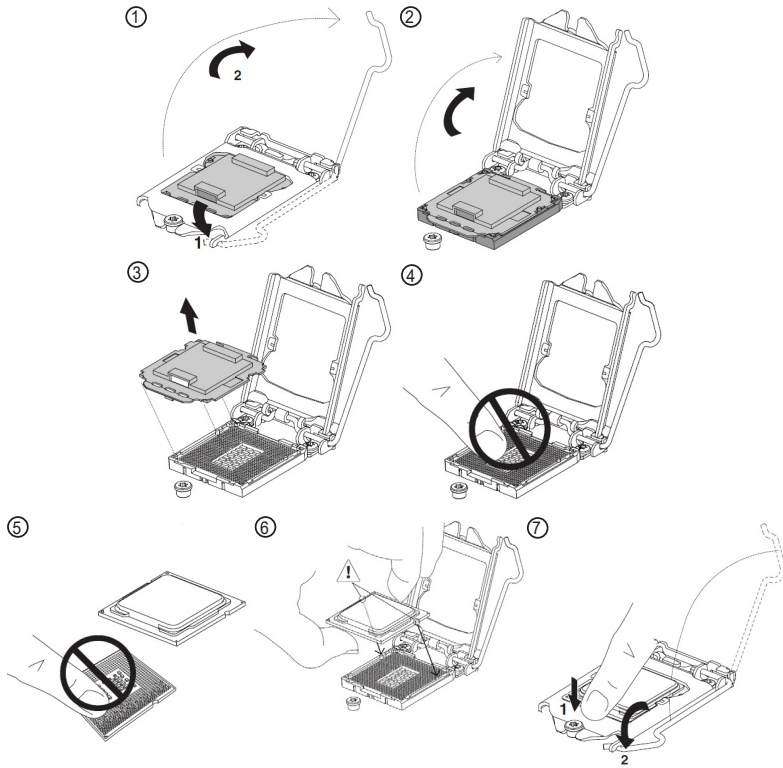

3. Find the heat sink in the accessory box. Attach the thermal pad to the heatsink, and remove the blue release liner.

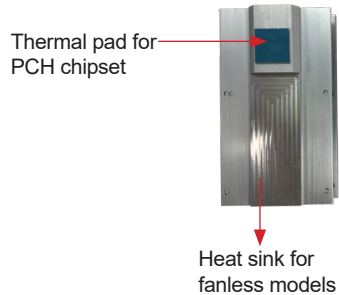

4. Apply the thermal paste to the CPU.
5. Place the heat sink on the CPU and PCH. Make sure that the thermal pad is in complete contact with the PCH chipset and the heat sink is in complete contact with the CPU to avoid overheating problem. If not, it would cause your system or CPU hanged, unstable or damaged.

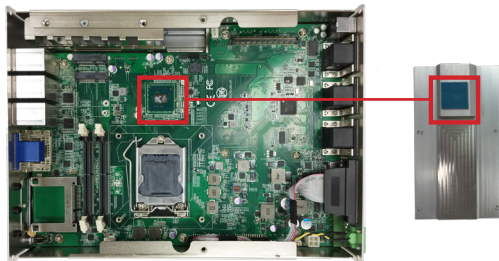

6. Secure the heat sink with 6 screws.

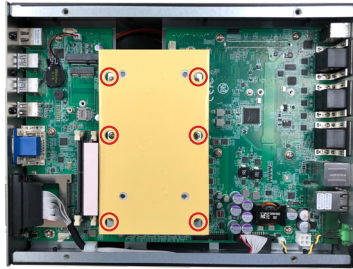

7. Restore the top cover to the computer by fastening the 8 screws as shown below. Note that the 4 screws in the middle are used to secure the top cover to the heat sink. Make sure they are tightened to ensure the heat dissipation.



4.1.3. Install/Uninstall Memory Modules

The main board has two memory module (DIMM) sockets. Increase memory capacity to make programs run faster on the system. The memory module for the FPC-810X Series' SO-DIMM sockets should be a 260-pin DDR4 with a "key notch" off the centre among the pins, which enables the memory module for particular applications. There are another two notches at each left and right side of the memory module to help fix the module in the socket.

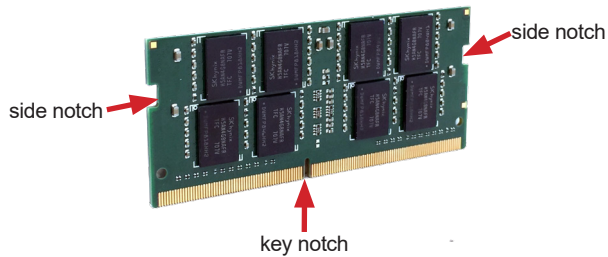

To install a DDR4 memory module:

1. Remove the top cover from the computer as described in [4.1.1.2. Remove Top Cover](#) on page [34](#).
2. Locate the SO-DIMM sockets on the main board.



The SO-DIMM sockets are vertical type, and each socket has two latches for fixing the memory modules. The memory module can only be installed by one direction due to the notch.

Installation & Maintenance

3. Pull back both latches from the socket.

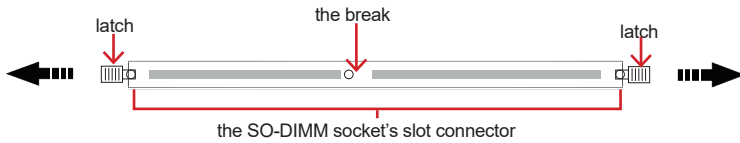

vertical-type SO-DIMM socket (overview)

4. Confront the memory module's edge connector side at the SO-DIMM socket. Position the memory module at the SO-DIMM socket, with the memory module's key notch aligned at the break of the SO-DIMM's slot connector.

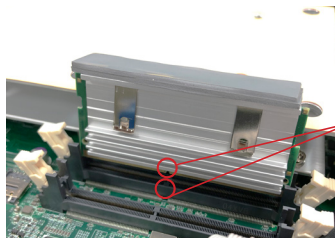

5. Vertically plug the memory module to the DIMM socket. "Fully" plug the memory module until both latches auto-lock the memory module in place.

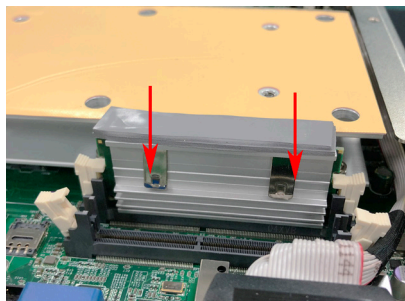

6. Restore the top cover to the computer.

To uninstall a DDR4 memory module:

1. Pull back both latches from the SO-DIMM socket.

The DDR4 memory module will be auto-released from the socket.

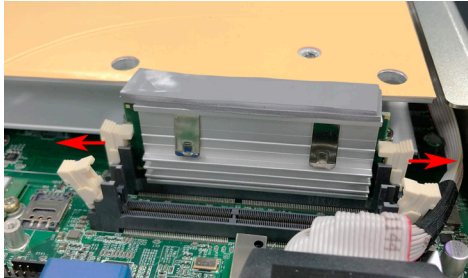

2. Remove the memory module.
3. Restore the top cover to the computer.

Installation & Maintenance

4.1.4. Install Wi-Fi Module

1. Remove the top cover from the computer as described in [4.1.1.2. Remove Top Cover](#) on page [34](#).
2. Locate the **M.2 E-Key** socket for wireless module.

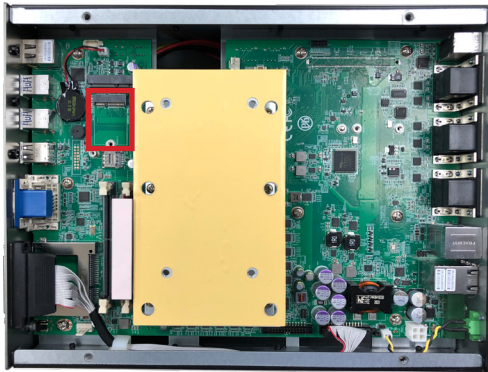

3. Prepare the Wi-Fi module kit. The module is a **M.2 E-Key** socket form factor, with two U.FL connectors, one is "MAIN", and the other is "AUX".

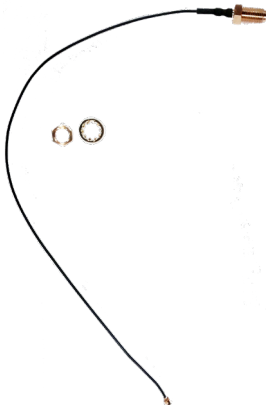

Two U.FL connectors, one is "MAIN" (marked 2), the other is "AUX" (marked 1).



4. Have the RF antenna. The antenna has an SMA connector on one end and an MHF connector on the other.

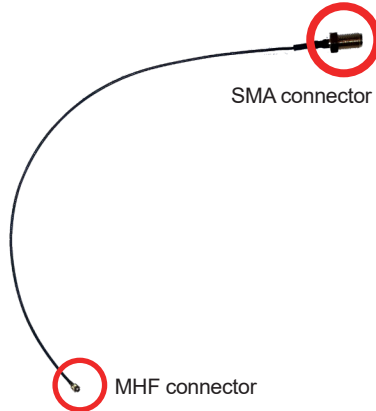

5. Connect the RF antenna's MHF connector to the Wi-Fi module's main connector marked 0. If you are going to connect a secondary antenna, connect it to the connector marked 1.

Connect the RF antenna's MHF connector to the Wi-Fi module's main connector (marked 2)

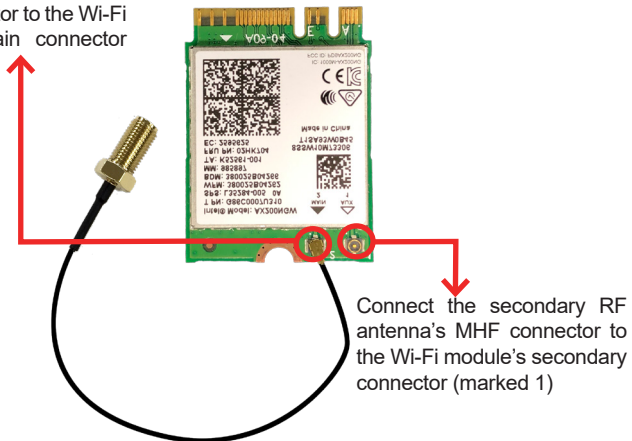

6. Plug the Wi-Fi module to the socket's connector by a slanted angle. Fully plug the module, and note the notch on the wireless module should meet the break of the connector.

Installation & Maintenance



The module's key notch should meet the connector's break.

7. Press the module down and fix the module in place using one screw.



8. Locate the SMA antenna holes on front panel. Remove the plastic plug to make an antenna hole. Keep the plastic plug for any possible restoration in the future.



9. From the other end of the RF antenna, which is an SMA connector, remove the washer and the nut. Note the SMA connector has the form of a threaded bolt, with one flat side.

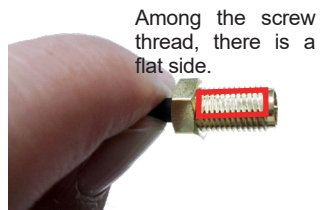
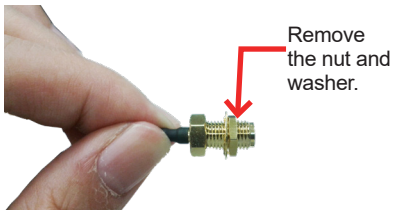

10. Pull the SMA connector through the above mentioned antenna hole. Note to meet the aforesaid flattened side with the antenna hole's flat side.



Arrange the flat side of the SMA connector to meet the flat side of the antenna hole.

11. Mount the washer first and then the nut to the SMA connector. Make sure the nut is tightened.



Mount the washer and the nut to the SMA connector. Tighten the nut.

12. Have the external antenna(s). Screw and tightly fasten the antenna(s) to the SMA connector.



4.1.5. Install/uninstall SIM Card

This section will use FPC-9107S-P6-G1 as the example to guide you through the SIM card installation steps:

1. Remove the top cover from the computer as described in [4.1.1.2. Remove Top Cover](#) on page [32](#).
2. Locate the SIM card slot on the main board.



- Slide the SIM card holder cover towards the OPEN edge and then lift the cover to open it.

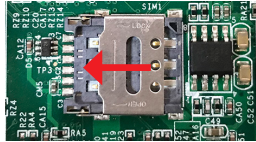

- Insert the SIM card into the card holder as shown below.



- Close the SIM card holder door and slide the door to the LOCK edge to lock into place.

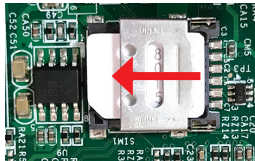

- Locate the MC2 slot and insert the relative communication module.



Installation & Maintenance

7. If the second SIM card is needed, please follow the steps above and install the SIM card in the second position as the picture.

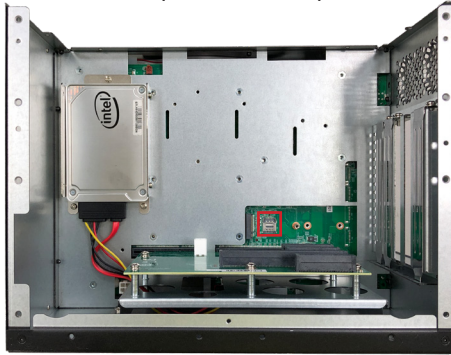

8. Locate the MC2/B key slot and insert the relative communication module.

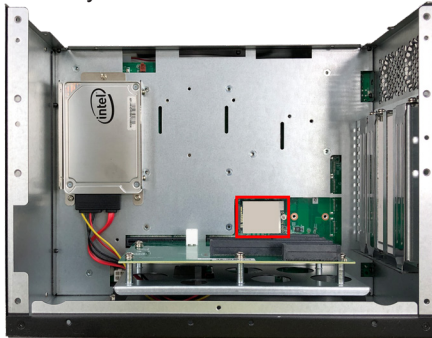

To uninstall the SIM card:

1. Locate the MC2 slot or B key slot and remove the communication module.
2. Locate the SIM card slot and slide the SIM card holder cover towards the OPEN edge and then lift the cover to open it.
3. Remove the SIM card.

4.1.6. Install SATA Storage Devices

4.1.6.1. Install Internal SATA Storage Device

1. Remove the bottom cover from the computer as described in [4.1.1.2. Remove Top Cover](#) on page [34](#).
2. Find the HDD/SSD brackets inside the computer. Loosen and remove the screws as marked in the illustration below. Then dismount the brackets from the computer.

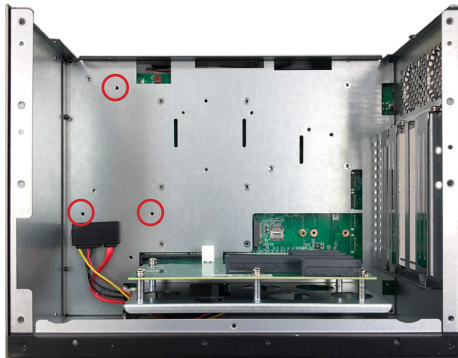

3. Attached the SATA cable to the HDD/SSD storage device. Slide the HDD/SSD storage device into the bracket and fix the storage device in place by fastening the 2 screws on both sides of the bracket .

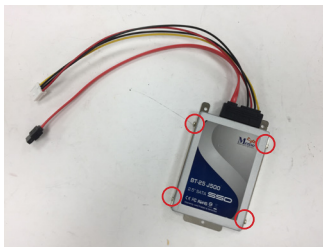

4. Install the bracket with the storage device back into the computer by refastening the 3 screws.

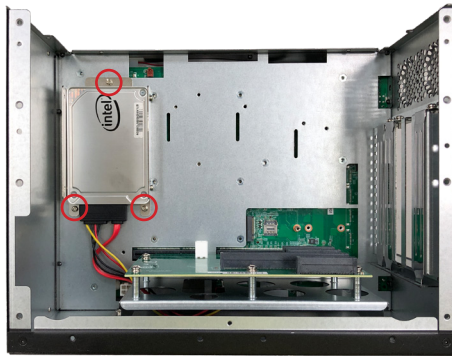

5. Connect the SATA signal cable and power cable.

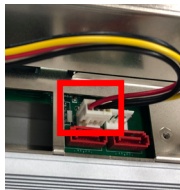

power cable

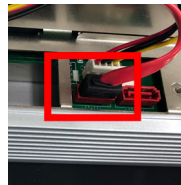

signal cable

6. Restore the bottom and top cover to the computer.

4.1.7. Install PCI and PCI Express Cards

To install a PCI or PCI Express card:

1. Remove the bottom cover from the computer as described in section [4.1.1.3. Remove the Side and Bottom Cover on page 35.](#)
2. Use a cross head screwdriver to loose the screw that secure the expansion slot bracket. And then you can install a PCIe card to this expansion slot.

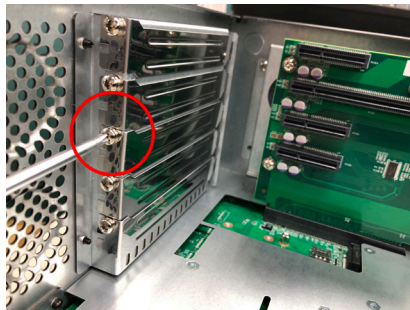

3. Restore the side and bottom cover to the computer.

4.1.8. Install/uninstall CFast Card

The computer supports a CFast card for storage and comes with an outside-accessible CFast slot. Follow through the guide below to install a CFast card to the computer.



Installation & Maintenance

Note: Be sure to turn off the computer before installing or uninstalling the CF card if the OS is installed on the card.

To install the CFast card:

1. From the front panel of the computer, find the door to the CFast slot. Loosen and remove the screw that locks the door.
2. Once the screw is removed, open the door. The CFast slot then comes to view.



3. Position the CFast card as directed by the graphic printed on the front panel. Insert the CFast card all the way into the slot.

To uninstall the CFast card:

1. Loosen and remove the card door screw and open the card door.
2. Push-eject the CFast card.
3. Remove the CFast card.
4. Refasten the screw to close the card door.

Note: Make sure to refasten the screw to close the card door each time the CFast card is installed or uninstalled.

4.1.9. Install graphic cards (For FPC-8108W-G1)

To install a graphic cards:

1. Remove the top and side cover from the computer.
2. Locate the PCIe slot on the riser card and install a graphic card into the computer.

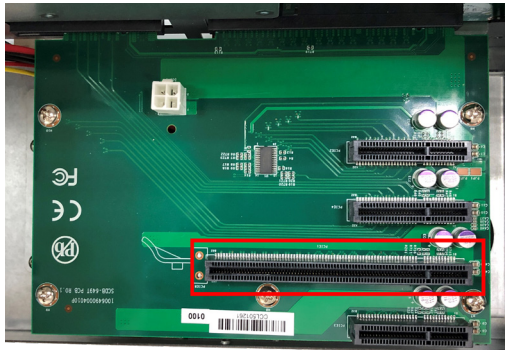

Installation & Maintenance

3. Use a cross head screwdriver to tighten the screws to secure the graphic card.

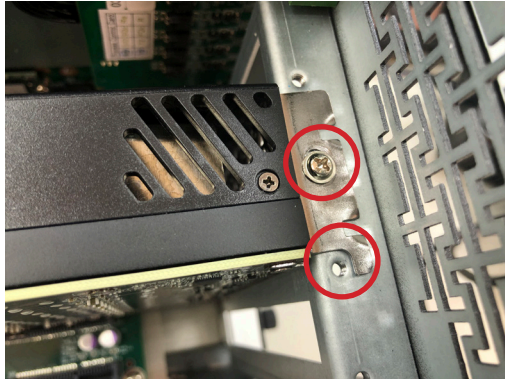

4. Locate the VGA card power connector on the board and plug the power plug of graphic card to computer.

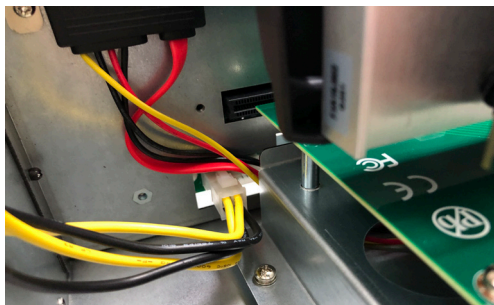

4.1.10. Install graphic cards (For FPC-8109-G1)

To install a graphic cards:

1. Remove the top and side cover from the computer.
2. Use a cross head screwdriver to loose 6 screws that secure the riser card, then remove the riser card.

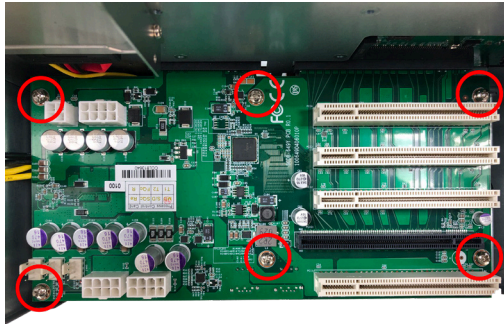

3. Locate the graphic card power connector, and plug the power connector.

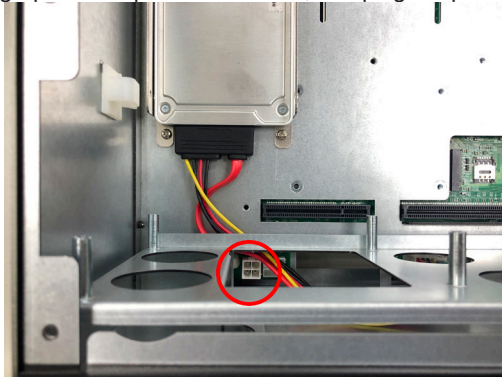

Installation & Maintenance

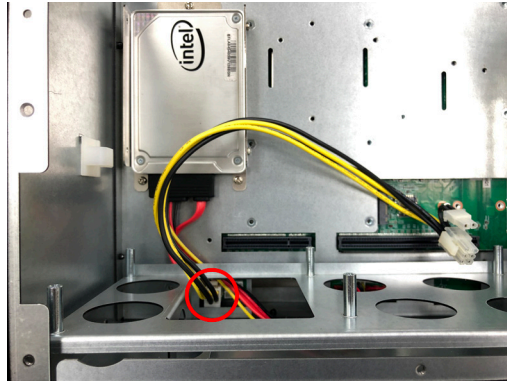

4. Install the riser card into the computer, tighten 6 screws to secure the riser card, and plug the graphic card. After that, plug the power plug into the graphic card.



5. Use a cross head screwdriver to tighten the screws to secure the graphic card.

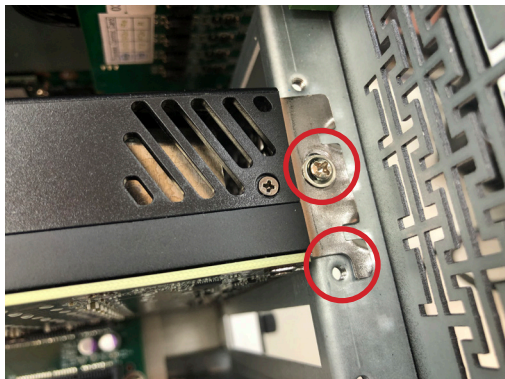

Note: Please note that the power connector depends on different graphic cards, and the power connector on the main board is a 4 PIN connector. Pin description as described in section [VGACARDPWR1 on page 25](#).

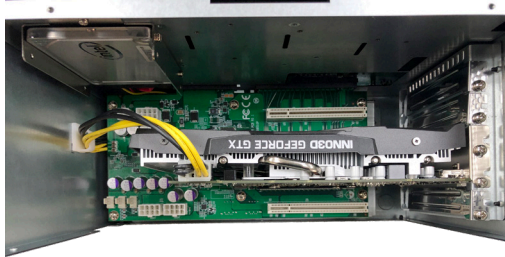

4.1.11. Install/uninstall SIM Card

This section will use FPC-8108W-G1 as the example to guide you through the SIM card installation steps:

1. Remove the top cover from the computer as described in [4.1.1.2. Remove Top Cover on page 34](#).
2. Locate the SIM card slot on the main board.



Installation & Maintenance

- Slide the SIM card holder cover towards the OPEN edge and then lift the cover to open it.

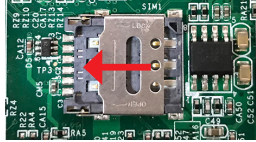

- Insert the SIM card into the card holder as shown below.



- Close the SIM card holder door and slide the door to the LOCK edge to lock into place.

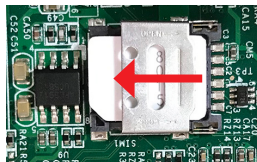

To uninstall the SIM card:

- Loosen and remove the card door screw and open the card door.
- Push-eject the SIM card.
- Remove the SIM card.
- Refasten the screw to close the card door.

Note: Make sure to refasten the screw to close the card door each time the SIM card is installed or uninstalled.

4.2. Ground the Computer

Follow the instructions below to ground the computer to land. Be sure to follow every grounding requirement in your place.



Warning Whenever the unit is installed, the ground connection must always be made first of all and disconnected lastly.

1. See the illustration below. Remove the ground screw from the rear panel.
2. Attach a ground wire to the rear panel with the screw.

4.3. Wire DC-in Power Source

4.3.1 Automation Mode

Follow the instructions below for connecting the computer to a DC-input power source.



Warning Only trained and qualified personnel are allowed to install or replace this equipment.

1. Before wiring, make sure the power source is disconnected.
2. Find the terminal block in the accessory box.
3. Use the wire-stripping tool to strip a short insulation segment from the output wires of the DC power source.
4. Identify the positive and negative feed positions for the terminal block connection. See the symbols printed on the rear panel indicating the polarities and DC-input power range in voltage.
5. Insert the exposed wires into the terminal block plugs. Only wires with insulation should extend from the terminal block plugs. Note that the polarities between the wires and the terminal block plugs must be positive to positive and negative to negative.

Installation & Maintenance

6. Use a slotted screwdriver to tighten the captive screws. Plug the terminal block firmly, which wired, into the receptacle on the rear panel.

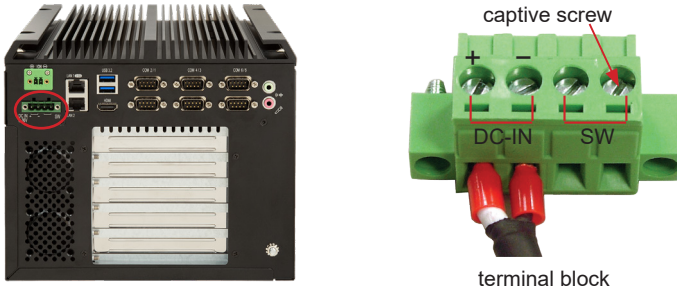

4.3.2 Vehicle Application Mode

Follow the instructions below for connecting the computer to a vehicle power source.

1. Make sure JACCON2 jumper is open for vehicle power mode. (Refer to [JACCON2 on page 21](#))
2. For vehicle application, DC power Input wiring pin configuration is as below. Please connect the Acc pin with your car Acc, and the device will be activated when you turn your ignition key to Acc.



Power on/off delay table(setting by BIOS) :

Item	Power on	Power off
1	manually operated	manually operated
2	manually operated	shutdown after 30 seconds
3	manually operated	shutdown after 60 seconds
4	manually operated	shutdown after 90 seconds
5	4 seconds power-on latency	manually operated
6	4 seconds power-on latency	shutdown after 30 seconds
7	4 seconds power-on latency	shutdown after 60 seconds
8	4 seconds power-on latency	shutdown after 90 seconds
9	8 seconds power-on latency	manually operated
10	8 seconds power-on latency	shutdown after 30 seconds
11	8 seconds power-on latency	shutdown after 60 seconds
12	8 seconds power-on latency	shutdown after 90 seconds
13	16 seconds power-on latency	manually operated
14	16 seconds power-on latency	shutdown after 30 seconds
15	16 seconds power-on latency	shutdown after 60 seconds
16	16 seconds power-on latency	shutdown after 90 seconds

For the Power on/off delay setting in the BIOS please see the description in [Section 5.5. Boot on page 94.](#)

This page is intentionally left blank.

Chapter 5

BIOS

BIOS

The BIOS Setup utility for the FPC-8108W-G1 / FPC-8109-G1 Series is featured by American Megatrends Inc to configure the system settings stored in the system's BIOS ROM. The BIOS is activated once the computer powers on. When the computer is off, the battery on the main board supplies power to BIOS RAM.

To enter the BIOS Setup utility, keep hitting the “Delete” key upon powering on the computer.

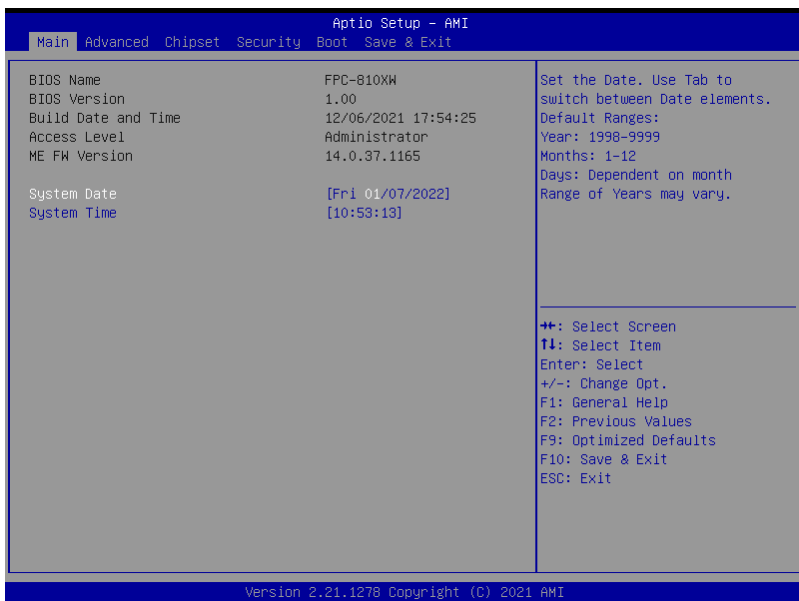

The featured settings are:

Menu	Description
Main	See 5.1. Main on page 68
Advanced	See 5.2. Advanced on page 69
Chipset	See 5.3. Chipset on page 86
Security	See 5.4. Security on page 92
Boot	See 5.5. Boot on page 94
Save & Exit	See 5.6. Save & Exit on page 96

Key Commands

The BIOS Setup utility relies on a keyboard to receive user's instructions. Hit the following keys to navigate within the utility and use the utility.

Keystroke	Function
← →	Moves left/right between the top menus.
↓ ↑	Moves up/down between highlight items.
Enter	Selects an highlighted item/field.
Esc	<ul style="list-style-type: none"> ▶ On the top menus: Use Esc to quit the utility without saving changes to CMOS. (The screen will prompt a message asking you to select OK or Cancel to exit discarding changes. ▶ On the submenus: Use Esc to quit current screen and return to the top menu.
Page Up / +	Increases current value to the next higher value or switches between available options.
Page Down / -	Decreases current value to the next lower value or switches between available options.
F1	Opens the Help of the BIOS Setup utility.
F2	Previous values
F9	Optimized defaults
F10	Exits the utility saving the changes that have been made. (The screen then prompts a message asking you to select OK or Cancel to exit saving changes.)

Note: Pay attention to the "WARNING" that shows at the left pane onscreen when making any change to the BIOS settings.

This BIOS Setup utility is updated from time to time to improve system performance and hence the screenshots hereinafter may not fully comply with what you actually have onscreen.

BIOS

5.1. Main

The **Main** menu features the settings of **System Date** and **System Time** and displays some BIOS info.

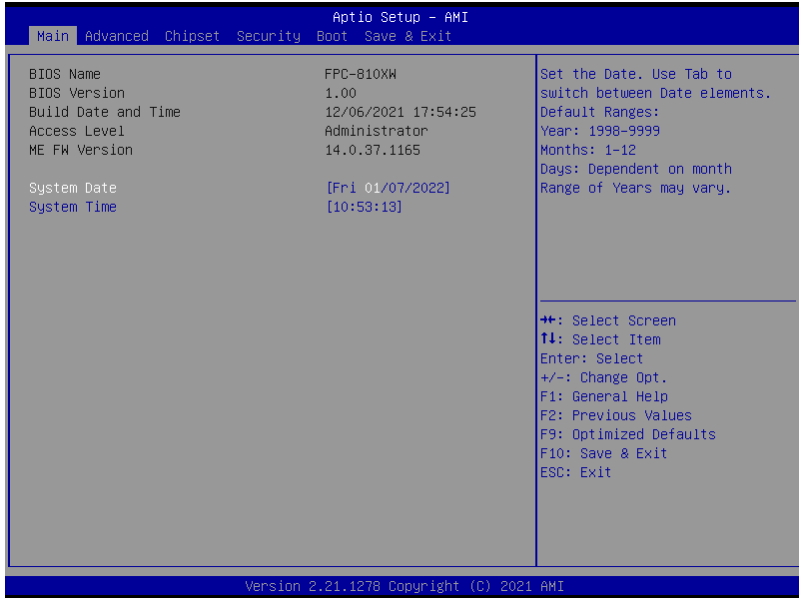

The featured settings are:

Setting	Description
System Date	Set the system date. Use Tab to switch between Data elements. Note that the 'Day' automatically changes when you set the date. ▶ The date format is: Day: Sun to Sat Month: 1 to 12 Date: 1 to 31 Year: 1998 to 2099
System Time	Set the system time. Use Tab to switch between Time elements. ▶ The time format is: Hour: 00 to 23 Minute: 00 to 59 Second: 00 to 59

5.2. Advanced

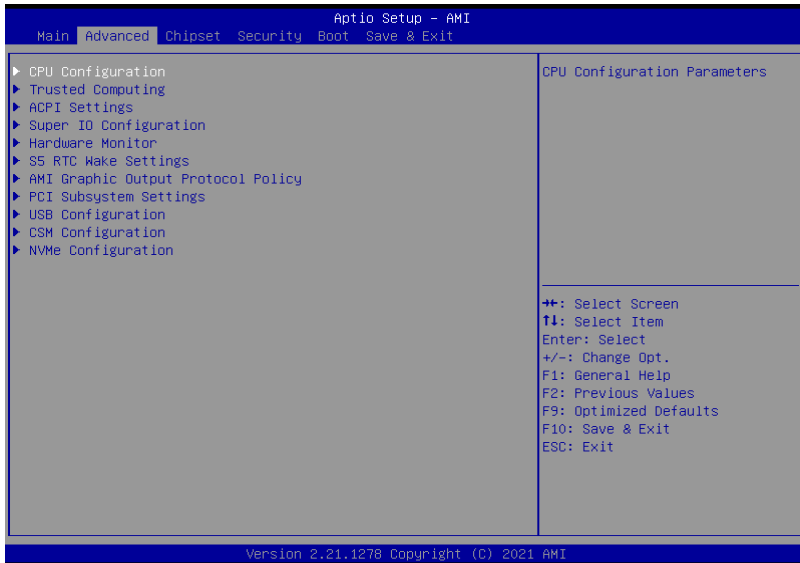

The featured settings and submenus are:

Setting	Description
CPU Configuration	See 5.2.1. CPU Configuration on page 70
Trusted Computing	See 5.2.2. Trusted Computing on page 72
ACPI Settings	See 5.2.3. ACPI Settings on page 73
Super IO Configuration	See 5.2.4. Super IO Configuration on page 74
Hardware Monitor	See 5.2.5. Hardware Monitor on page 77
S5 RTC Wake Settings	See 5.2.6. S5 RTC Wake Settings on page 78
AMI Graphic Output Protocol policy	See 5.2.7 AMI Graphic Output Protocol policy on page 79
PCI Subsystem Settings	See 5.2.8. PCI Sybssystem Settings on page 80
USB Configuration	See 5.2.9. USB Configuration on page 81
CSM Configuration	See 5.2.10. CSM Configuration (For FPC-8108W-G1) on page 83 and 5.2.10. CSM Configuration (For FPC-8109-G1) on page 84
NVMe Configuration	See 5.2.11. NVMe Configuration on page 85

5.2.1. CPU Configuration

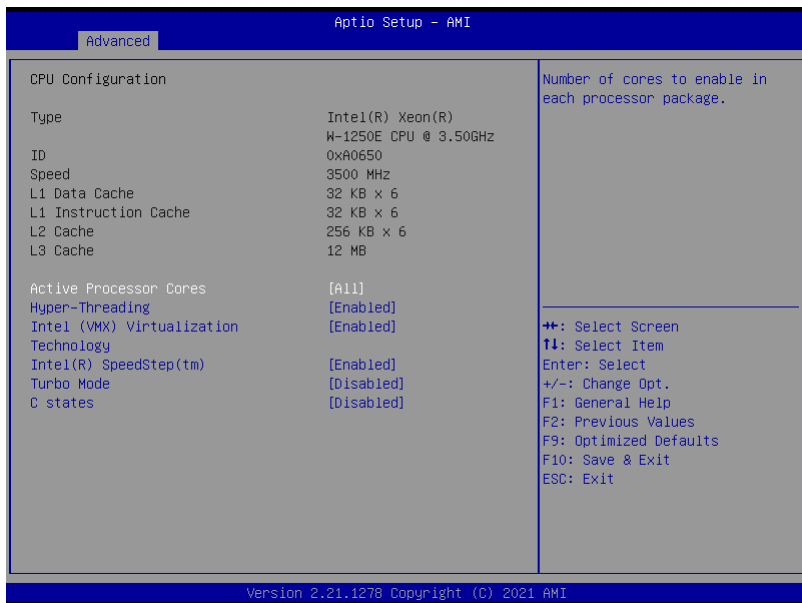

The features settings are:

Setting	Description
Active Processor Cores	Number of cores to enable in each processor package. ▶ Options: All (default) and 1
Hyper-Threading	Enabled (default) for Windows XP and Linux (OS optimized for Hyper-Threading Technology) and Disabled for other OS (OS not optimized or Hyper-Threading Technology). When disabled only one thread per enabled core is enabled.
Intel (VMX) Virtualization Technology	When enabled, a VMM can utilize the additional hardware capabilities provided by Vanderpool Technology. ▶ Options: Enabled (default) or Disabled
Intel (R) Speed Step (tm)	Enable (default)/ Disable Intel SpeedStep. Allows more than two frequency ranges to be supported.
Turbo Mode	Only available when Intel Speed Step is Enabled . Enable /Disable (default) Turbo Mode (requires EMTTM enabled, unless max turbo ratio is bigger than 16 - SKL AO W/A.

C States

Enable /Disable (default) CPU power management. Allows CPU to go to C state when it's not 100% utilized.

BIOS

5.2.2. Trusted Computing



The features settings are:

Setting	Description
Security Device Support	Enable (default) or Disable BIOS support for security device.
Pending operation	Schedule an Operation for the security Device. Your computer will reboot during restart in order to change State of Security Device. ▶ Options: None (default) and TPM Clear

5.2.3. ACPI Settings

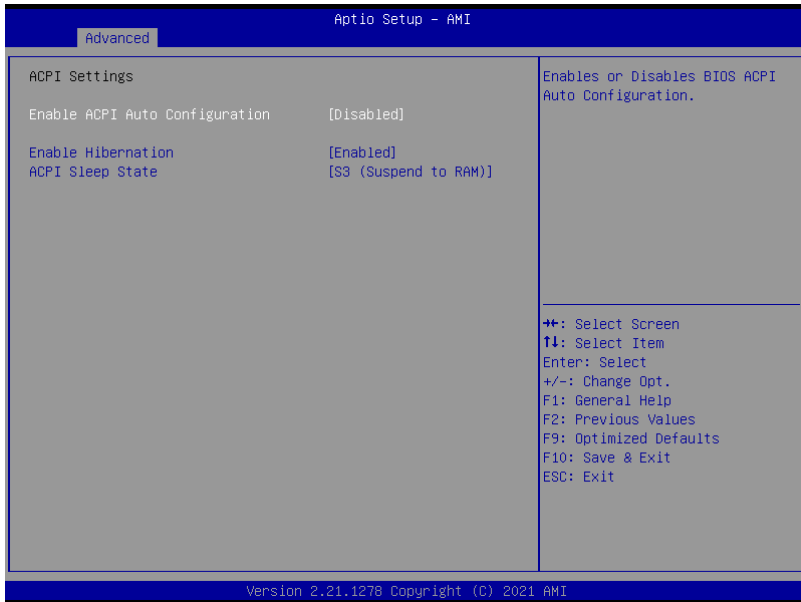

The features settings are:

Setting	Description
Enable ACPI Auto Configuration	Enables or Disables (default) BIOS ACPI Auto Configuration
Enable Hibernation	Enables (default) or Disables System ability to Hibernate (OS/S4 Sleep State). This option may be not effective with some OS.
ACPI Sleep State	Select ACPI sleep state the system will enter when the SUSPEND button is pressed. ► Options: Suspend Disabled and S3 (Suspend to RAM) (default)

5.2.4. Super IO Configuration

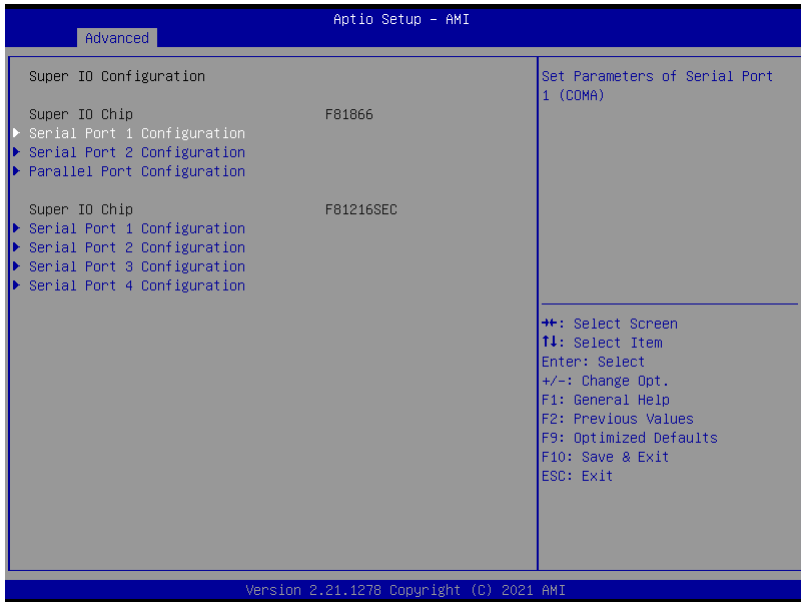

Super IO Chip F81866 Settings

Setting	Description
Serial Port Configuration	
Serial Port	Enable (default) or Disable Serial Port (COM).
Mode Select	Select RS-232 (default), RS-422 , RS-485 , RS-422 Termination Resistor or RS-485 Termination Resistor
Parallel Port Configuration	
Parallel Port	Enable (default) or Disable Parallel Port (LPT/LPTE).

Device Mode	Change the printer port mode: ▶ Options: STD Printer Mode (default) ; SPP Mode ; EPP-1.9 and SPP Mode ; EPP-1.7 and SPP Mode ; ECP Mode ; ECP and EPP 1.9 Mode ; ECP and EPP 1.7 Mode
--------------------	--

BIOS

Super IO Chip F81216SEC Settings

Serial Port Configuration	
Serial Port	Enable (default) or Disable Serial Port (COM).

5.2.5. Hardware Monitor



The features settings are:

Setting	Description
CPUFAN SmartFan Function	Enables (default) or Disables Smart Fan
SYSFAN SmartFan Function	Boundary 1~4 & Segment Speed 1~5 Auto fan speed control. Fan speed will follow different temperature by different PRM 1-100.

Note: CPUFAN & SYSFAN functions only apply to SKUs with smart fan. If your SKU doesn't come with smart fan, ignore these settings.

5.2.6. S5 RTC Wake Settings

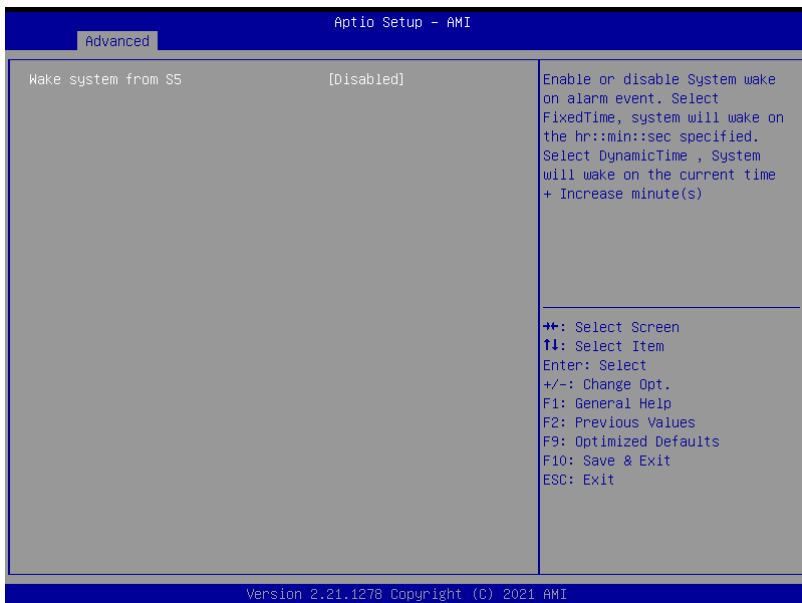

The features settings are:

Setting	Description
Wake System from S5	<p>Enable or Disable (default) system wake on alarm event.</p> <ul style="list-style-type: none"> Options available are: <ul style="list-style-type: none"> Disabled (default): Fixed Time: System will wake on the hr::min::sec specified. DynamicTime: If selected, you need to set Wake up minute increase from 1 - 5. System will wake on the current time + increase minute(s).

5.2.7 AMI Graphic Output Protocol policy

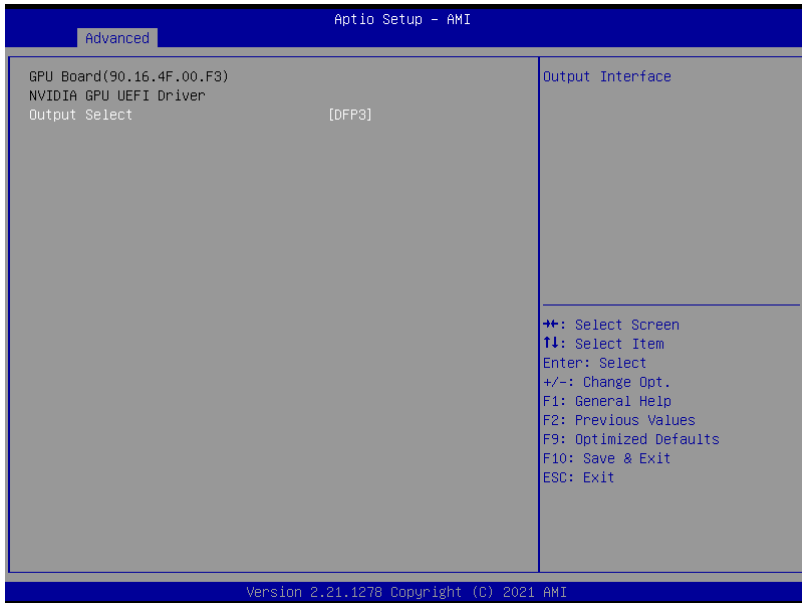

The features settings are:

Setting	Description
Output select	Output Select

5.2.8. PCI Sybssystem Settings

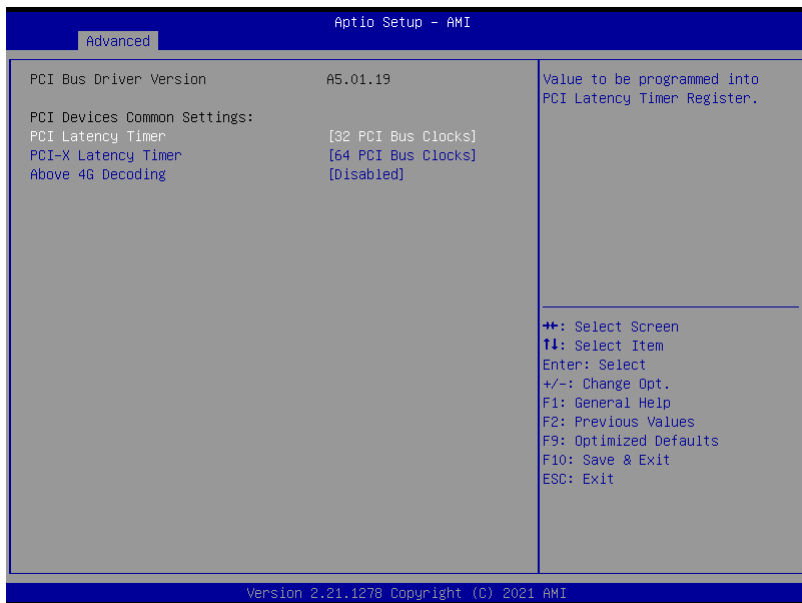

The features settings are:

Setting	Description
PCI Latency Timer	Value to be programmed into PCI Latency Timer Register. ► Options: 32 (default), 64, 96, 128, 160, 192, 224 and 248 PCI Bus Clocks.
PCI-X Latency Timer	Value to be programmed into PCI-X Latency Timer Register. ► Options: 32, 64 (default), 96, 128, 160, 192, 224 and 248 PCI Bus Clocks.
Above 4G Decoding	Enable/Disable (default) 64bit capable Devices to be Decoded in Above 4G Address Space (Only if System Supports 64 bit PCI Decoding).

5.2.9. USB Configuration

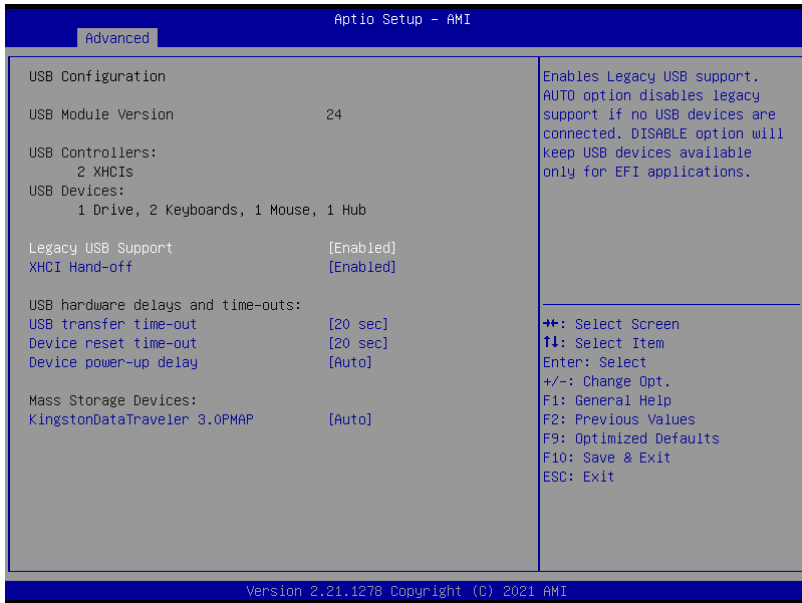

The features settings are:

Setting	Description
Legacy USB Support	<p>Enables/disables legacy USB support.</p> <ul style="list-style-type: none"> Options available are Enabled (default), Disabled and Auto. Select Auto to disable legacy support if no USB device are connected. Select Disabled to keep USB devices available only for EFI applications.
XHCI Hand-off	<p>This is a workaround for OSeS without XHCI hand-off support. The XHCI ownership change should be claimed by XHCI driver.</p> <ul style="list-style-type: none"> The optional settings are: Enabled (default) / Disabled.
USB Transfer time-out	<p>Use this item to set the time-out value for control, bulk, and interrupt transfers.</p> <ul style="list-style-type: none"> Options: 1 sec, 5 sec, 10 sec, 20 sec (default).

Device reset time-out	Use this item to set USB mass storage device start unit command time-out. ▶ Options available are: 10 sec, 20 sec (default), 30 sec, 40 sec
Device power-up delay	Use this item to set maximum time the device will take before it properly reports itself to the host controller. 'Auto' uses default value: for a root port it is 100 ms, for a hub port the delay is taken from hub descriptor. ▶ Options available are: Auto: Default Manual: Select Manual you can set value for the following sub-item: 'Device Power-up delay in seconds', the delay range in from 1 to 40 seconds, in one second increments.

5.2.10. CSM Configuration (For FPC-8108W-G1)

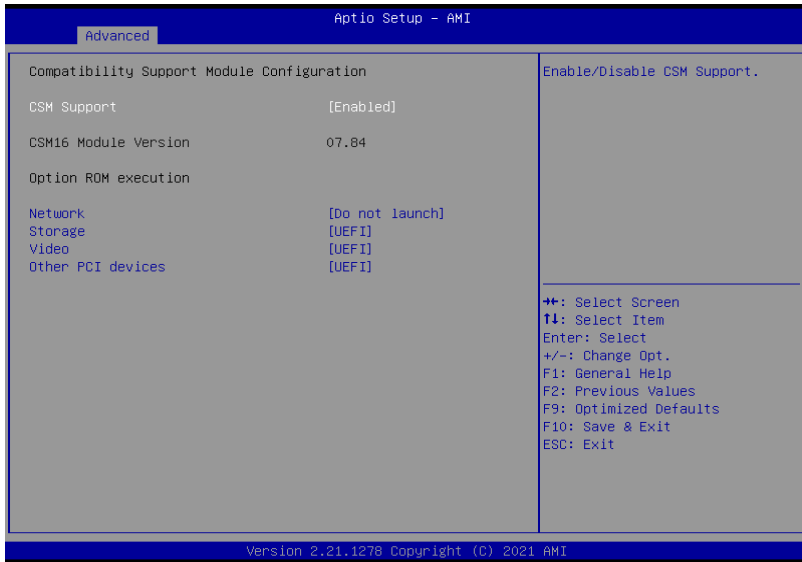

The features settings are:

Setting	Description
CSM Support	Enable (default) or Disable CSM Support.
Network	Control the execution of UEFI execution policy ▶ Options: Do not launch (default) and UEFI
Storage	Control the execution of UEFI OpROM ▶ Options: Do not launch and UEFI (default)
Video	Control the execution of UEFI and Legacy Video OpROM ▶ Options: Do not launch and UEFI (default)
Other PCI devices	Determines OpROM execution policy for devices other than network, storage or video ▶ Options: Do not launch and UEFI (default)

5.2.10. CSM Configuration (For FPC-8109-G1)

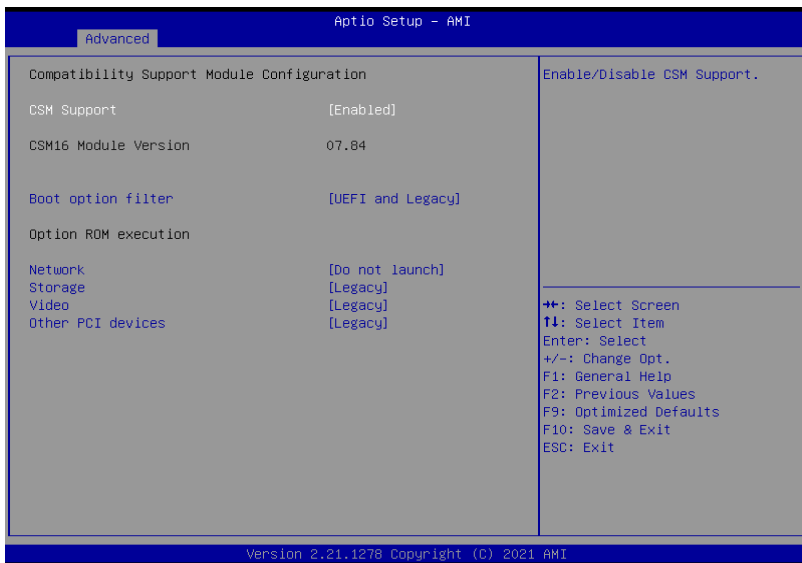

The features settings are:

Setting	Description
CSM Support	Enable (default) or Disable CSM Support.
Boot option filter	Control the Legacy/UEFI ROMs priority. ▶ Options: UEFI and Legacy (default), Legacy only and UEFI only
Network	Control the execution of UEFI and Legacy PXE OpROM ▶ Options: Do not launch (default), UEFI and Legacy
Storage	Control the execution of UEFI and Legacy Storage OpROM ▶ Options: Do not launch and Legacy (default)
Video	Control the execution of UEFI and Legacy Video OpROM ▶ Options: UEFI and Legacy (default)
Other PCI devices	Determines OpROM execution policy for devices other than network, storage or video ▶ Options: Do not launch and Legacy (default)

5.2.11. NVMe Configuration

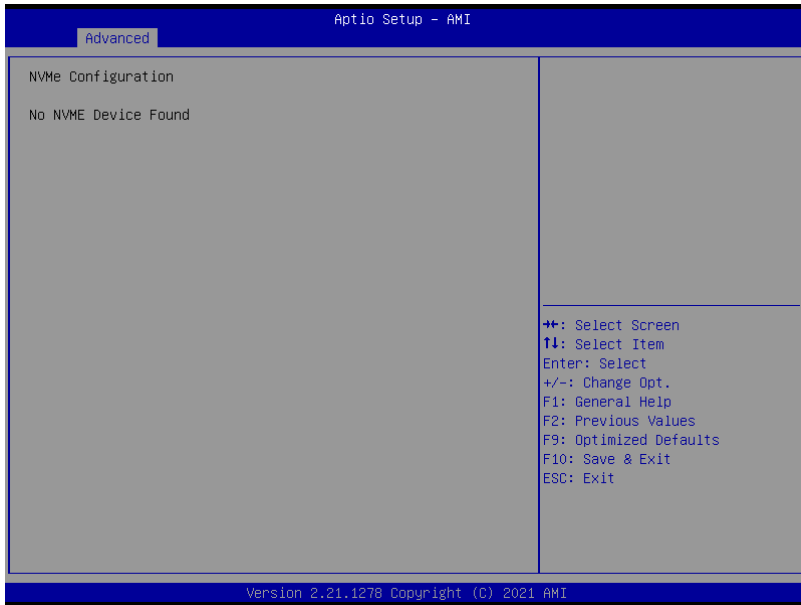

Access this submenu to view the NVMe controller and driver information.

5.3. Chipset

The **Chipset** menu controls the system's chipset.

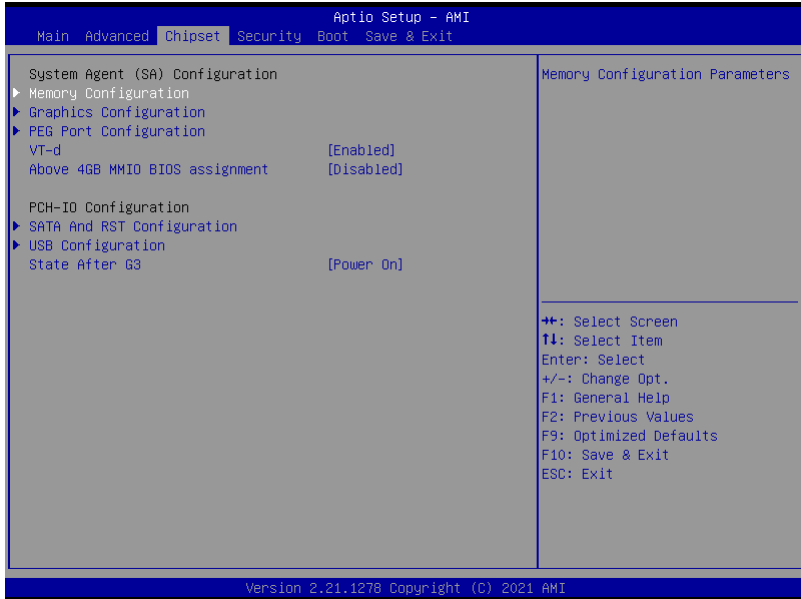

The features settings are:

Setting	Description
System Agent (SA) Configuration	
Memory Configuration	Access this submenu to view the memory configuration.
Graphics Configuration	See 5.3.1.1. Graphics Configuration on page 88.
PEG Port Configuration	<p>PEG port options</p> <p>Enable Root Port: Enable or Disable the root port.</p> <ul style="list-style-type: none"> ▶ Options: Auto (default), Enabled and Disabled. <p>Max Link Speed: Configure PEG 0:1:0 Max Speed.</p> <ul style="list-style-type: none"> ▶ Options: Auto (default), Gen1, Gen 2 and Gen3.

VT-d	Enable (default) or Disable VT-d function
Above 4GB MMIO BIOS assignment	Enable or Disable (default) Above 4GB MMIO BIOS assignment. This is enabled automatically when aperture size is set to 2048MB.
PCH-IO Configuration	
SATA And RST Configuration	See 5.3.1.2. SATA And RST Configuration on page 90
USB Configuration	See 5.3.1.3. USB Configuration on page 91
State After G3	Specify what state to go to when power is re-applied after a power failure (G3 state). ▶ Options available are Power On (default), Power Off and Last State .

5.3.1.1. Graphics Configuration

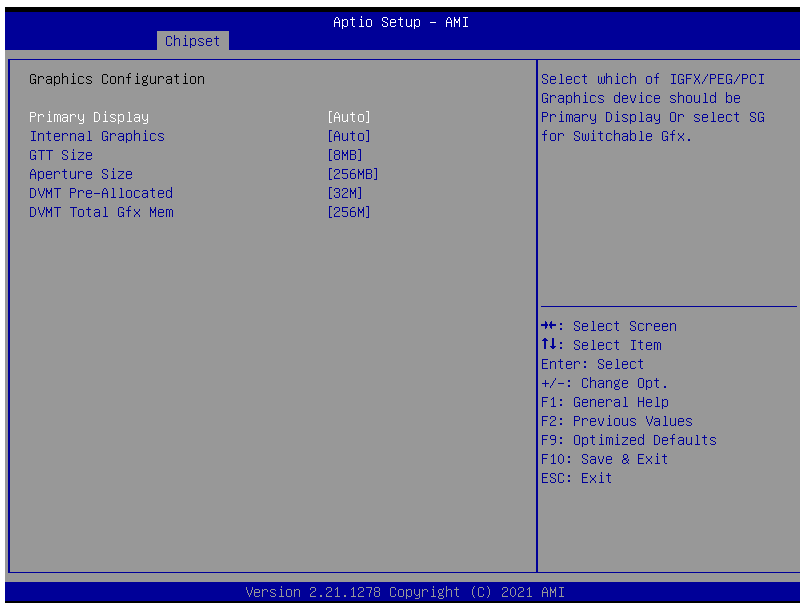

The features settings are:

Setting	Description
Primary Display	Select the Graphics device which will be activated as Primary Display. ▶ Options available are Auto (default), IGFX , PEG and PCI
Internal Graphics	Enables/disables the IGD. ▶ Options available are Auto (default), Disabled , and Enabled .
GTT Size	Select the GTT Size. ▶ Options: 4MB , 2MB and 8MB (default).
Aperture Size	Select the Aperture Size. Note that above 4GB MMIO BIOS assignment is automatically enabled when selecting 2048MB aperture. To use this feature, please disable CSM support. ▶ Options: 128MB , 256MB (default), 512MB , 1024MB and 2048MB

DVMT Pre-Allocated	Select the DVMT 5.0 Pre-allocated (Fixed) Graphic Memory size used by the Internal Graphic Device. ▶ 32M is the default.
DVMT Total Gfx Mem	Select the DVMT 5.0 Total Graphic Memory size used by the Internal Graphic Device. ▶ Options: 128M , 256M (default) and Max .

5.3.1.2. SATA And RST Configuration

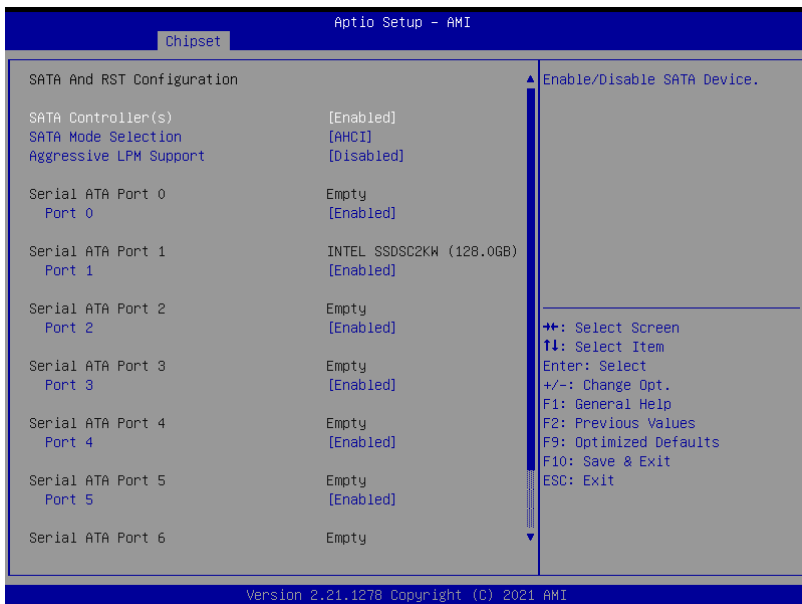

The features settings are:

Setting	Description
SATA Controller(s)	Enables (default) / Disables SATA device(s).
Aggressive LPM Support	Enables / Disables (default) PCH to aggressively enter link power state.
Serial ATA Port 0~3	SATA device information. Enables (default) / Disables the SATA port. *Available SATA ports depend on your model.

5.3.1.3. USB Configuration



The features settings are:

Setting	Description
XHCI Disable Compliance Mode	Options to disable Compliance Mode. Default is FALSE (default) to not disable Compliance Mode. Set TRUE to disable Compliance Mode.
xDCI Support	Enable / Disable (default) xDCI (USB OTG Device).

5.4. Security

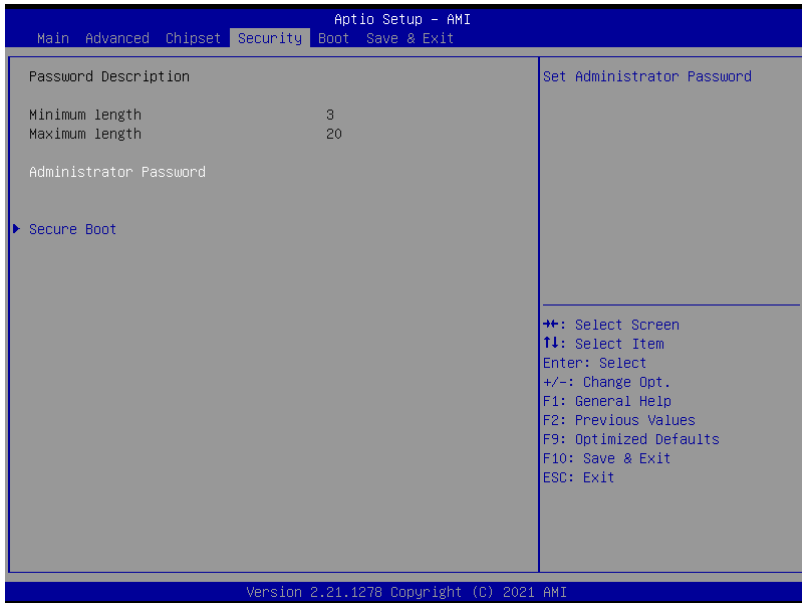

The features settings are:

Setting	Description
Administrator Password	To set up an administrator password: 1. Select Administrator Password . 2. An Create New Password dialog then pops up onscreen. 3. Enter your desired password that is no less than 3 characters and no more than 20 characters. 4. Hit [Enter] key to submit.
Security Boot	See 5.4.1. Security Boot on page 93 ..

5.4.1. Security Boot

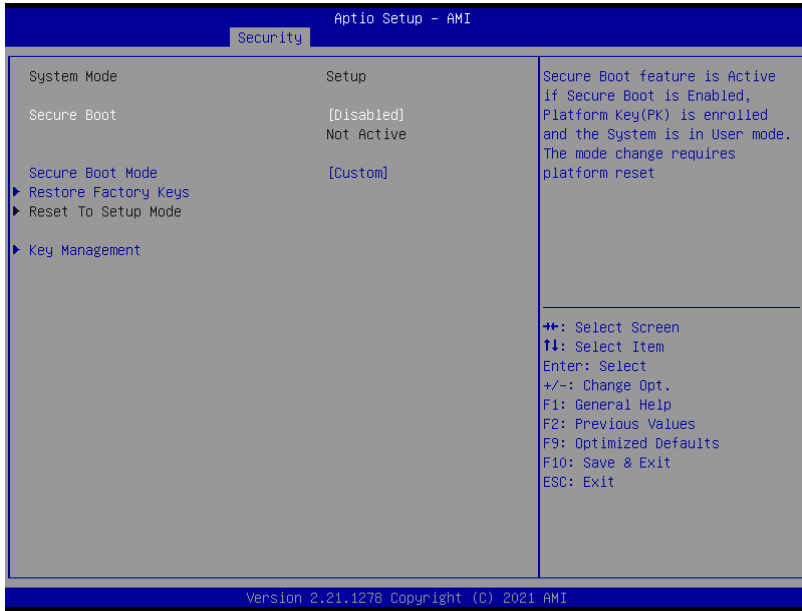

The features settings are:

Setting	Description
Secure Boot	Enable/Disable (default) secure boot.
Secure Boot Mode	Allow users to set the secure boot selector. Standard/Custom (default) mode.
Restore Factory Keys	Force system to restore default secure boot key database.
Reset to Setup Mode	Delete all secure boot key databases.
Key Management	Allow users to modify secure variables and set key management page.

5.5. Boot

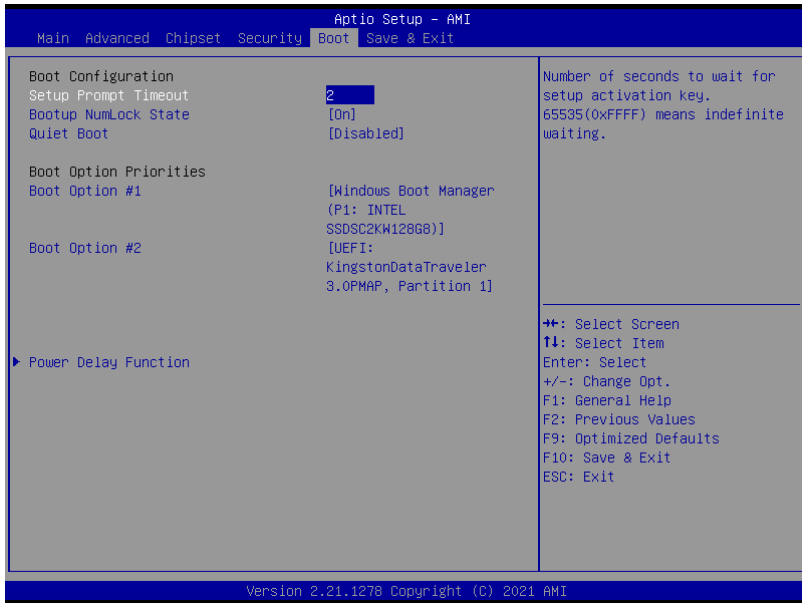

The features settings are:

Setting	Description
Setup Prompt Timeout	Set how long to wait for the prompt to show for entering BIOS Setup. <ul style="list-style-type: none"> ▶ The default setting is 1 (sec). ▶ Set it to 65535 to wait indefinitely.
Bootup NumLock State	Sets whether to enable or disable the keyboard's NumLock state when the system starts up. <ul style="list-style-type: none"> ▶ Options available are On (default) and Off.
Quiet Boot	Sets whether to display the POST (Power-on Self Tests) messages or the system manufacturer's full screen logo during booting. <ul style="list-style-type: none"> ▶ Select Disabled to display the normal POST message, which is the default.
Boot Option Priority	Set the system boot priorities.

Hard Drive BBS Priorities	Sets the order of the legacy devices in this group. BBS means "BIOS Boot Specification".
Power Delay Function	<p>Power Delay Function Set the system support power delay function.</p> <p>▶ Options: Enable (default): Support power delay function. Disable: Power on/off manually operated.</p> <p>Power on delay Select the time which the system will power on.</p> <p>▶ Options: Manually Operator (default), 04 Seconds, 08 Seconds and 16 Seconds.</p> <p>Power off delay Select the time which the system will shutdown.</p> <p>▶ Options: Manually Operator (default), 30 Seconds, 60 Seconds and 90 Seconds.</p>

5.6. Save & Exit

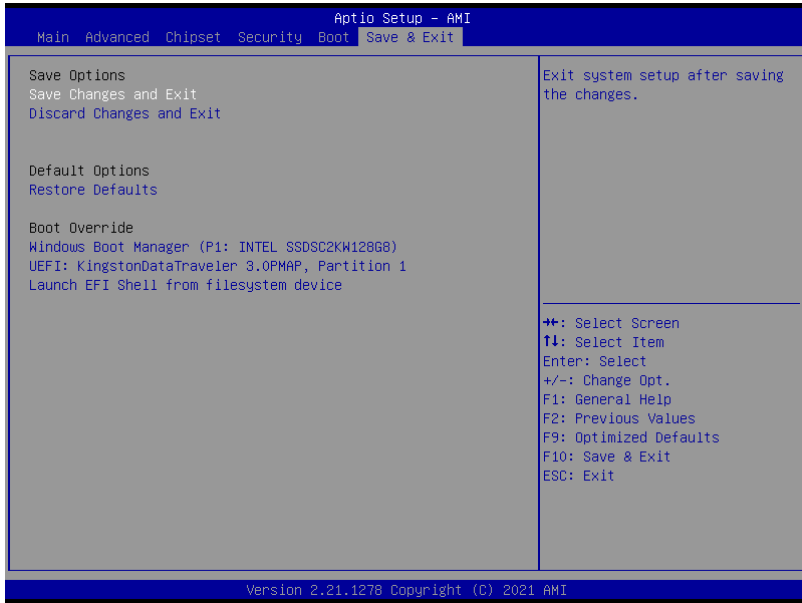

The features settings are:

Setting	Description
Save Changes and Reset	Saves the changes and quits the BIOS Setup utility.
Discard Changes and Exit	Quits the BIOS Setup utility without saving the change(s).
Restore Defaults	Restores all settings to defaults. ▶ This is a command to launch an action from the BIOS Setup utility.
Boot Override	Boot Override presents a list in context with the boot devices in the system. ▶ P0: Select the device to boot up the system regardless of the currently configured boot priority. ▶ Launch EFI Shell from filesystem device: Attempts to launch EFI Shell Application (Shell.efi) from one of the available filesystem devices.



Appendices

A: Digital I/O Setting

Digital I/O can read from or write to a line or an entire digital port, which is a collection of lines. This mechanism helps users achieve various applications such as industrial automation, customized circuit, and laboratory testing. Take the source code below that is written in C for the digital I/O application example.

Sample Codes:

```
/*-----*/
-----*/
#include <math.h>
#include <stdio.h>
#include <dos.h>

int sioIndex = 0x2E;
int sioData = 0x2F;

int main(void)
{
    int iData;

    SioGPIOMode(0xFF00);
    delay(2000);

    SioGPIOData(0x5500);
    delay(2000);

    iData = SioGPIOStatus();
    printf(" Input : %2x \n",iData);
    delay(2000);

    SioGPIOData(0xAA00);
    delay(2000);

    iData = SioGPIOStatus();
    printf(" Input : %2x \n",iData);
    delay(2000);

    return 0;
}

void SioGPIOMode(int iMode)
{
    int iTemp;

    outportb(sioIndex,0x87); /* Enable
Super I/O */
    outportb(sioIndex,0x87);

    outportb(sioIndex,0x07); /* Select
```

```

logic device - GPIO */
    outportb(sioData, 0x06);

    outportb(sioIndex,0x30);                                /* Enable
GPIO */
    outportb(sioData, 0x01);

        iTemp = iMode & 0x00FF;
    outportb(sioIndex,0xA0);                                /* GPIO
50~57 - Output Enable */
    outportb(sioData,iTemp);

        iTemp = (iMode & 0xFF00) >> 8;
    outportb(sioIndex,0xF0);                                /* GPIO
00~07 - Output Enable */
    outportb(sioData,iTemp);

        outportb(sioIndex,0xAA);                            /* Disable
Super I/O */
}

void SioGPIOData(int iData)
{
    int iTemp;

    outportb(sioIndex,0x87);                                /* Enable
Super I/O */
    outportb(sioIndex,0x87);

    outportb(sioIndex,0x07);                                /* Select
logic device - GPIO */
    outportb(sioData, 0x06);

        iTemp = iData & 0x00FF;
    outportb(sioIndex,0xA1);                                /* GPIO
50~57 - Output Data */
    outportb(sioData,iTemp);

        iTemp = (iData & 0xFF00) >> 8;
    outportb(sioIndex,0xF1);                                /* GPIO
00~07 - Output Data */
    outportb(sioData,iTemp);

        outportb(sioIndex,0xAA);                            /* Disable
Super I/O */
}

int SioGPIOStatus()
{
    int iStatus;
    int iTemp;

```

Appendices

```
        outportb(sioIndex,0x87);                               /* Enable
Super I/O */
        outportb(sioIndex,0x87);

        outportb(sioIndex,0x07);                               /* Select
logic device - GPIO */
        outportb(sioData, 0x06);

        outportb(sioIndex,0xA2);                               /* GPIO
50~57 - Status */
        iTemp = inportb(sioData);

        outportb(sioIndex,0xF2);                               /* GPIO
00~07 - Status */
        iStatus = inportb(sioData);

        outportb(sioIndex,0xAA);                               /* Disable
Super I/O */

        iStatus = (iStatus<<8) + iTemp;

        return iStatus;
}
```

B: Watchdog Timer (WDT) Setting

WDT is widely used for industry application to monitor the activity of CPU. Application software depends on its requirement to trigger WDT with adequate timer setting. Before WDT time out, the functional normal system will reload the WDT. The WDT never time out for a normal system. The WDT will not be reloaded by an abnormal system, then WDT will time out and auto-reset the system to avoid abnormal operation.

This computer supports 255 levels watchdog timer by software programming I/O ports.

Below is an assembly program example to disable and load WDT.

Sample Codes:

```

/*-----
----*/
#include <math.h>
#include <stdio.h>
#include <dos.h>

int sioIndex = 0x4E;          /* or 0x2E */
int sioData = 0x4F;         /* or 0x2F */

int main(void)
{
    int iCount;
    printf("WDT Times ( 1 ~ 255 ) : \0");
    scanf("%d",&iCount);
    printf("\n");

    SioWDTStart(iCount);

    while(1)
    {
        iCount = SioWDTCount();
        printf("\r Counts : %d ",iCount);
        sleep(1);
    }

    return 0;
}

void SioWDTStart(int iCount)
{
    outportb(sioIndex, 0x87);          /* Enable
Super I/O */

```

Appendices

```
        outportb(sioIndex, 0x87);

        outportb(sioIndex, 0x07); /* Select
logic device - WDT */
        outportb(sioData, 0x07);

        outportb(sioIndex, 0x30); /* Enable
WDT */
        outportb(sioData, 0x01);

        outportb(sioIndex, 0xFA); /* Enable
WDRST# Output */
        outportb(sioData, 0x01);

        outportb(sioIndex, 0xF6); /* Set WDT
Timeout value */
        outportb(sioData, iCount);

        outportb(sioIndex, 0xF5); /* Set
Configure and Enable WDT timer, Start countdown */
        outportb(sioData, 0x32);

        outportb(sioIndex, 0xAA); /* Disable
Super I/O */
    }

void SioWDTStop(void)
{
    outportb(sioIndex, 0x87); /* Enable
Super I/O */
    outportb(sioIndex, 0x87);

    outportb(sioIndex, 0x07); /* Select
logic device - WDT */
    outportb(sioData, 0x07);

    outportb(sioIndex, 0xF5); /* Disable
WDT timer, stop countdown */
    outportb(sioData, 0x12);

    outportb(sioIndex, 0xAA); /* Disable
Super I/O */
}

void SioWDTClear(int iCount)
{
    outportb(sioIndex, 0x87); /* Enable
Super I/O */
    outportb(sioIndex, 0x87);

    outportb(sioIndex, 0x07); /* Select
```

```
logic device - WDT */
    outportb(sioData, 0x07);

        outportb(sioIndex, 0xF6);                /* Reset WDT
Timeout Value */
        outportb(sioData, iCount);

        outportb(sioIndex, 0xAA);                /* Disable
Super I/O */
    }

int SioWDTCount(void)
{
    int iData;

        outportb(sioIndex, 0x87);                /* Enable
Super I/O */
        outportb(sioIndex, 0x87);

        outportb(sioIndex, 0x07);                /* Select
logic device - WDT */
        outportb(sioData, 0x07);

        outportb(sioIndex, 0xF6);                /* Get count
of timer */
        iData = inportb(sioData);

        outportb(sioIndex, 0xAA);                /* Disable
Super I/O */

    return iData;
}
```