SCP Cube

**New-Generation Supercapacitor Industrial
Power Backup Solution**

User's Manual

Version 1.0

Revision History

Version	Date	Description
1.0	2018.10	Initial release

Revision History ii

Contents i

Preface..... iii

Chapter 1 - Introduction..... 1

 1.1 Product Highlights 2

 1.2 Package Contents..... 2

 1.3 Ordering Information 2

 1.4 Dimensions 3

 1.5 Specifications..... 3

Chapter 2 - Installation & Configuration..... 5

 2.1 Getting to Know the SCP Cube 6

 2.2 Connection..... 7

 2.3 Ensure Your PC Restart Automatically After a Power Outage 9

 2.3 DIN-Rail Mounting 10

 2.4 Monitoring Power Status..... 10

 2.5 Configuring the SCP Cube (Optional)..... 12

Chapter 3 - Operation Mode 15

 3.1 Operation When DC Power is Available 16

 3.2 Operation When DC Power is Not Available..... 17

 3.3 Operation When DC Power Resumes 19

Copyright Notice

All Rights Reserved.

The information in this document is subject to change without prior notice in order to improve the reliability, design and function. It does not represent a commitment on the part of the manufacturer.

Under no circumstances will the manufacturer be liable for any direct, indirect, special, incidental, or consequential damages arising from the use or inability to use the product or documentation, even if advised of the possibility of such damages.

This document contains proprietary information protected by copyright. All rights are reserved. No part of this document may be reproduced by any mechanical, electronic, or other means in any form without prior written permission of the manufacturer.

Declaration of Conformity

CE

The CE symbol on your product indicates that it is in compliance with the directives of the Union European (EU). A Certificate of Compliance is available by contacting Technical Support.

This product has passed the CE test for environmental specifications when shielded cables are used for external wiring. We recommend the use of shielded cables. This kind of cable is available from ARBOR. Please contact your local supplier for ordering information.

Warning

This is a class A product. In a domestic environment this product may cause radio interference in which case the user may be required to take adequate measures.

FCC Class A

This device complies with Part 15 of the FCC Rules. Operation is subject to the following two conditions:

- (1) This device may not cause harmful interference, and
- (2) This device must accept any interference received, including interference that may cause undesired operation.

NOTE:

This equipment has been tested and found to comply with the limits for a Class A digital device, pursuant to Part 15 of the FCC Rules. These limits are designed to provide reasonable protection against harmful interference when the equipment is operated in a commercial environment. This equipment generates, uses, and can radiate radio frequency energy and, if not installed and used in accordance with the instruction manual, may cause harmful interference to radio communications. Operation of this equipment in a residential area is likely to cause harmful interference in which case the user will be required to correct the interference at his own expense.

RoHS

ARBOR Technology Corp. certifies that all components in its products are in compliance and conform to the European Union's Restriction of Use of Hazardous Substances in Electrical and Electronic Equipment (RoHS) Directive 2002/95/EC.

The above mentioned directive was published on 2/13/2003. The main purpose of the directive is to prohibit the use of lead, mercury, cadmium, hexavalent chromium, polybrominated biphenyls (PBB), and polybrominated diphenyl ethers (PBDE) in electrical and electronic products. Member states of the EU are to enforce by 7/1/2006.

ARBOR Technology Corp. hereby states that the listed products do not contain unintentional additions of lead, mercury, hex chrome, PBB or PBDB that exceed a maximum concentration value of 0.1% by weight or for cadmium exceed 0.01% by weight, per homogenous material. Homogenous material is defined as a substance or mixture of substances with uniform composition (such as solders, resins, plating, etc.). Lead-free solder is used for all terminations (Sn(96-96.5%), Ag(3.0-3.5%) and Cu(0.5%)).

SVHC / REACH

To minimize the environmental impact and take more responsibility to the earth we live, Arbor hereby confirms all products comply with the restriction of SVHC (Substances of Very High Concern) in (EC) 1907/2006 (REACH --Registration, Evaluation, Authorization, and Restriction of Chemicals) regulated by the European Union.

All substances listed in SVHC < 0.1 % by weight (1000 ppm)

Important Safety Instructions

Read these safety instructions carefully

1. Read all cautions and warnings on the equipment.
2. Place this equipment on a reliable surface when installing. Dropping it or letting it fall may cause damage
3. Make sure the correct voltage is connected to the equipment.
4. For pluggable equipment, the socket outlet should be near the equipment and should be easily accessible.
5. Keep this equipment away from humidity.
6. The openings on the enclosure are for air convection and protect the equipment from overheating. **DO NOT COVER THE OPENINGS.**
7. Position the power cord so that people cannot step on it. Do not place anything over the power cord.
8. Never pour any liquid into opening. This may cause fire or electrical shock.
9. Never open the equipment. For safety reasons, the equipment should be opened only by qualified service personnel.
10. If one of the following situations arises, get the equipment checked by service personnel:
 - a. The power cord or plug is damaged.
 - b. Liquid has penetrated into the equipment.
 - c. The equipment has been exposed to moisture.
 - d. The equipment does not work well, or you cannot get it to work according to the user's manual.
 - e. The equipment has been dropped or damaged.
 - f. The equipment has obvious signs of breakage.
11. Keep this User's Manual for later reference.

Warning

The Box PC and its components contain very delicately Integrated Circuits (IC). To protect the Box PC and its components against damage caused by static electricity, you should always follow the precautions below when handling it:

1. Disconnect your Box PC from the power source when you want to work on the inside.
2. Use a grounded wrist strap when handling computer components.
3. Place components on a grounded antistatic pad or on the bag that came with the Box PC, whenever components are separated from the system.

Supercapacitor Replacement

Incorrect replacement of the supercapacitor may lead to malfunction of the product. The supercapacitor must be replaced by the manufacturer.

Do not throw supercapacitors into the trash can. It must be disposed of in accordance with local regulations concerning special waste.

Technical Support

If you have any technical difficulties, please contact us at:

<https://www.arbor-technology.com>

Warranty

This product is warranted to be in good working order for a period of one year from the date of purchase. Should this product fail to be in good working order at any time during this period, we will, at our option, replace or repair it at no additional charge except as set forth in the following terms. This warranty does not apply to products damaged by misuse, modifications, accident or disaster.

Vendor assumes no liability for any damages, lost profits, lost savings or any other incidental or consequential damage resulting from the use, misuse of, or inability to use this product. Vendor will not be liable for any claim made by any other related party.

Vendors disclaim all other warranties, either expressed or implied, including but not limited to implied warranties of merchantability and fitness for a particular purpose, with respect to the hardware, the accompanying product's manual(s) and written materials, and any accompanying hardware. This limited warranty gives you specific legal rights.

Return authorization must be obtained from the vendor before returned merchandise will be accepted. Authorization can be obtained by calling or faxing the vendor and requesting a Return Merchandise Authorization (RMA) number. Returned goods should always be accompanied by a clear problem description.

This page is intentionally left blank.

Chapter 1

Introduction

1.1 Product Highlights

- Designed for industrial box PC & panel PC
- Maintenance free supercapacitors
- Safe and reliable; no danger of fire or explosion
- No danger of overcharging
- Fully discharged for safety
- Environmentally friendly without hazardous materials
- Wide operating temperature range (-20°C to 70°C)
- Multi-function control utility

1.2 Package Contents

Upon opening the package, carefully inspect the contents. If any of the items is missing or appears damaged, contact your local dealer or distributor. The package should contain the following items:



1 x SCP Cube



1 x **Accessory Box** that contains the following items:

- 1 x User's manual
- 1 x USB to USB cable
- 1 x RS-232 DB9 to DB9 cable
- 2 x 3-pin plug for terminal block

1.3 Ordering Information

SCP-43	4S3P supercap power backup system
SCP-41	4S1P supercap power backup system

1.4 Dimensions

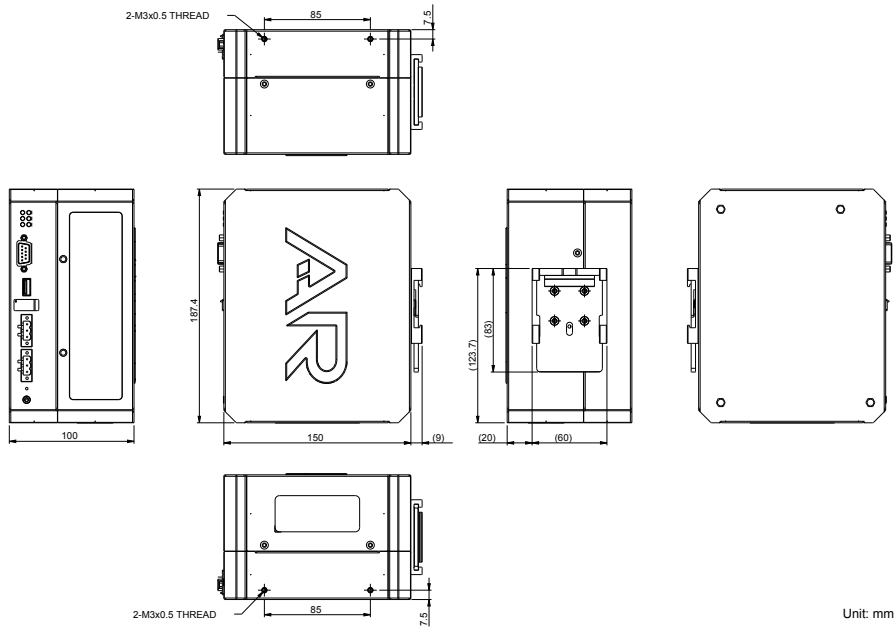

1.5 Specifications

System	
Chip	High current supercap backup controller
Supercapacitor	
Capacity	400 Farads / each
Power Requirement	
Power Input	DC 12~28V input support
Power Output	DC 12V / 24V output with switch support
I/O	
Power In	1 x 3-pin terminal block
Power Out	1 x 3-pin terminal block

Switch	1 x slide switch for power output control
USB	1 x Type-A connector
COM	1 x COM with RS-232
Environmental	
Operating Temp.	-20°C ~ 70°C (-4°F ~ 140°F)
Storage Temp.	-30°C ~ 80°C (-22°F ~ 158°F)
Operating Humidity	10 ~ 95% RH @ 70°C (non-condensing)
Vibration	0.5 Grms/5~500Hz/random operation
Shock	Operating 10G (11ms), non-operating 30G
Mechanical	
Mounting	DIN rail mount with bracket
Chassis	DIN rail-mounting chassis, and SGCC steel chassis
Weight	2.2 kg (4.85lb)
Dimensions (W x D x H)	100 X 150 X 187.4 mm (3.94" x 5.91" x 7.38")
OS Support	
Windows 7/10	

Chapter 2



Installation

2.1 Getting to Know the SCP Cube



No.	Item	Descriptions
1	Status LED	Displays power & charging status. See below for details.
2	COM Port	RS-232 COM Port To connect to industrial PC system for monitoring SCP Cube power status.
3	USB Port	USB 2.0 Port To connect to industrial PC system for monitoring SCP Cube power status.
4	Power Output Switch	Select 24V or 12V output voltage according to the power input of the connected industrial PC system.
5	Power Input	DC 12~28V wide voltage power input terminal block To connect to the power source.
6	Power Output Terminal Block	DC 24V or 12V power output terminal block To connect to the power input of the industrial PC system.
7	Ground Screw	Ground screw for ground connection.
8	DIN-Rail Mounting Clip	For DIN-rail mounting.

Status LED

Group	Item	Color	Descriptions
PWR IN (Top)	ON	Green	Solid: SCP Cube is connected to power source.
	OFF	Red	Solid: SCP Cube is disconnected from power source.
Charging (Middle)		Yellow	Solid: SCP Cube is charging from the power source. Flashing: SCP Cube is exporting power to connected device.
		Green	Solid: SCP Cube is fully charged.
PWR OUT (Bottom)	24V	Green	Solid: SCP Cube power output is 24V.
	12V	Blue	Solid: SCP Cube power output is 12V.

The following is a depiction of some different states of the SCP Cube:



The SCP Cube is connected to a power source.
Charging is in process.
The power output mode is 12V.

The SCP Cube is disconnected from a power source.
It's exporting power to the connected device.
The power output mode is 24V.

The SCP Cube is connected to a power source.
It's fully charged.
The power output mode is 24V.

2.2 Connection

A. Wiring the Power Input and Power Output

1. Before wiring, make sure the power source is disconnected.
2. Find the terminal block in the accessory box.
3. Use the wire-stripping tool to strip a short insulation segment from the output wires of the DC power source.
4. Identify the positive and negative feed positions for the terminal block connection. See the symbols printed on the panel indicating the polarities and power range in voltage.
5. Insert the exposed wires into the terminal block plugs. Only wires with insulation should extend from the terminal block plugs. Note that the polarities between the wires and the terminal block plugs must be positive to positive and negative to negative.
6. Use a slotted screwdriver to tighten the captive screws. Plug the terminal block firmly, which wired, into the receptacle on the rear panel.

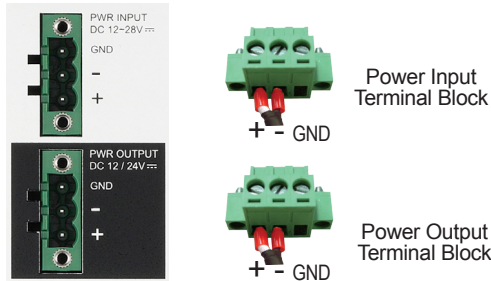

B. Connecting the SCP Cube to Your Industrial PC System

1. Connect the power input of your IPC to the power output of the SCP Cube.
2. Slide the **PWR OUTPUT VOLTAGE** switch on the SCP Cube to 24V or 12V according to the power input of the connected system.

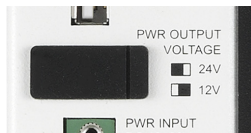

3. To monitor the SCP Cube power status, connect the SCP Cube to your industrial PC system via USB or COM port.

If you are using USB port, you need to install USB-to-COM port driver. See next section for details.

C. Connecting the SCP Cube to power source

Connect the power input of the SCP Cube to the power source (DC 12~28V).

D. Grounding the SCP Cube

Remove the ground screw from the front panel. Then attach a ground wire to the panel with the screw.

The following diagram illustrates a sample connection. Actual connection may vary according to your industrial PC system.

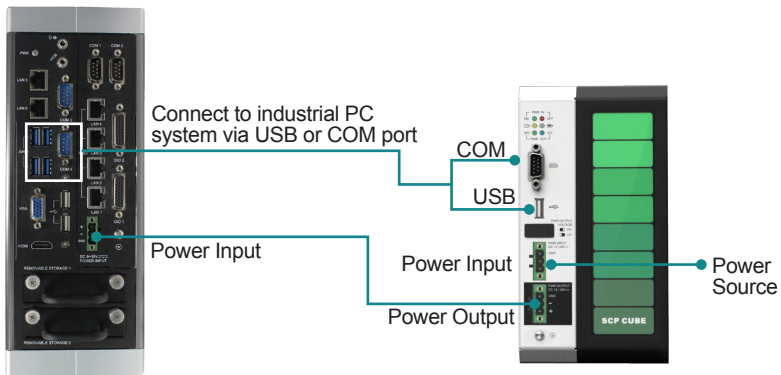

Connection Diagram Example

2.3 Ensure Your PC is On Automatically When Power Resumes

To ensure that your industrial PC restarts automatically after a power outage is over, you have to enable the computer to "see" the power returning by configuring the PC's BIOS settings as described below:

1. Open your computer's BIOS settings menu.
2. Look for the Power Settings menu. Ensure the **"Power on after Power Loss"** (or similar) setting is set to **"Power On"** as the example below:

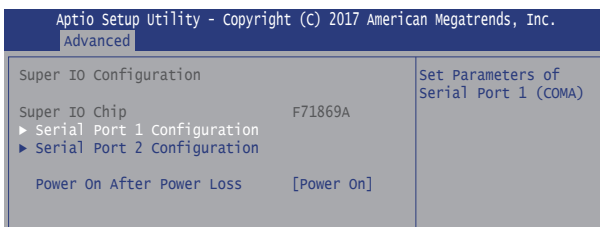

2.3 DIN-Rail Mounting

The DIN-rail mounting clip is screwed on the SCP Cube in the factory. To DIN mount the SCP Cube:

1. Snap the DIN Rail clip to the upper edge of the DIN Rail.
2. Press the SCP Cube firmly downward towards the DIN Rail until the DIN Rail clip tab engages and snaps to the bottom edge of the DIN Rail.

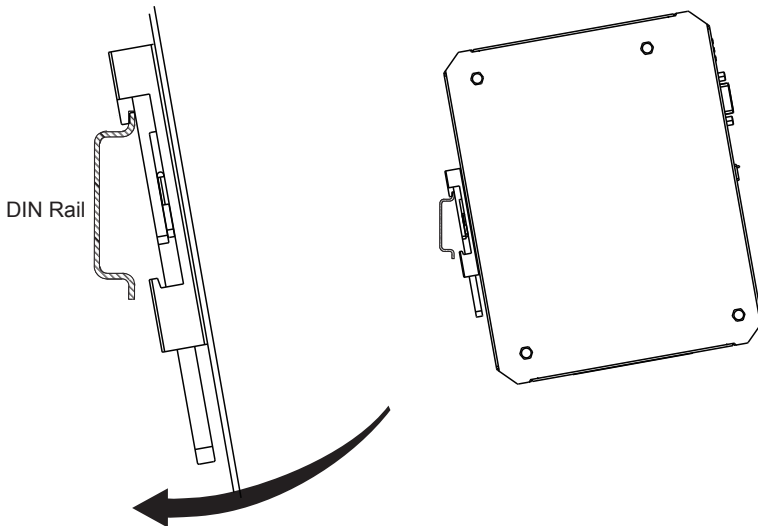

2.4 Monitoring Power Status

Prerequisites

The SCP Cube comes with a Windows-based monitoring utility to monitor the SCP Cube power status. You can also use the utility to configure the shutdown mode and timeout settings.

To use the utility, make sure your industrial PC system meets the following requirement:

- Windows system with **.NET Framework 3.5** or above installed.

- **USB-to-COM driver installed:** This is required only if the SCP Cube is connected to your industrial PC system via USB port. To install the driver:
 1. Visit ARBOR website and locate the driver page of the SCP Cube. Download the driver and save it to the industrial PC.
 2. Extract the files. Double-click the **CDM21226_Setup.exe** file and follow the on-screen instructions to complete the installation.
- Download the SCP Cube utility.

Visit ARBOR website and locate the driver page of SCP Cube. Download exe file of the **SCP Cube Utility** and save it to the industrial PC.

Monitoring SCP Cube Power Status

Run the exe file of the **SCP Cube Utility** to launch the utility, and then on the **Status** tab you can view the SCP Cube power information.

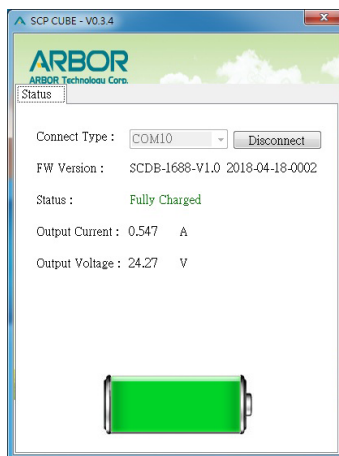

The following information are provided:

- **COM port:** The number of the COM interface connected to the SCP Cube.
- **FW version:** The firmware version of the SCP Cube.
- **Status:** The charging status of the SCP Cube.
 - **Fully Charged:** The SCP Cube is fully charged from the connected power system.

- **Charging:** The SCP Cube is charging from the connected power system.
- **Discharging:** Power system is disconnected from the SCP Cube and the charging is stopped.
- **Output current:** The SCP Cube's output current.
- **Output voltage:** The SCP Cube's output voltage.

2.5 Configuring the SCP Cube (Optional)

The SCP Cube utility allows you to configure the shutdown mode and timeout settings in case of power loss. If you need to make the configuration:

1. Launch the SCP Cube monitoring utility. On the **Status** tab, click the **Disconnect** button.

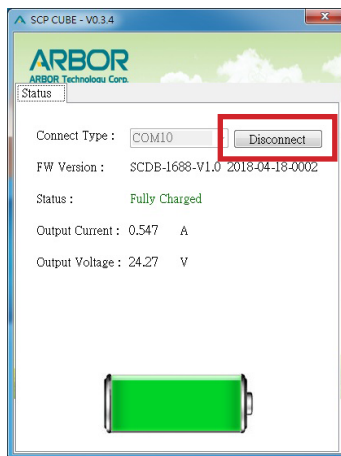

2. The connection between the SCP Cube and the industrial PC system will be disconnected and the originally displayed values will disappear. A **Settings** tab will appear. Click the **Settings** tab.

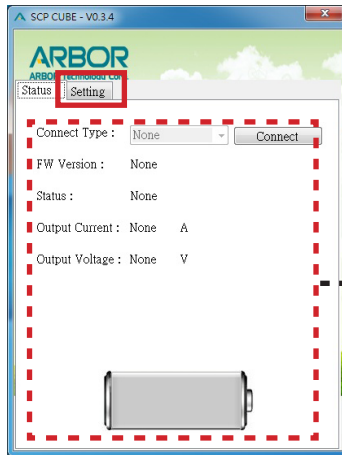

When using the utility for configuration purpose, the connection between the SCP Cube and the industrial PC system will be disconnected.

As a result, no information will be displayed on the **Status** tab at this moment.

On the **Settings** tab, you can configure the following settings:

- **Power State Selection:** Select the power off mode upon power loss. Options include **Hibernate (S4)** (default) and **Soft Off (S5)**.
 - **Hibernate (S4):** The system saves the contents of volatile memory to a hard drive. After coming back from S4, the user can resume work where it was left off.
 - **Soft off (S5):** Known as a shutdown. The entire user session is torn down and restarted on the next boot. As a result a startup from this state takes longer than S4.

- **Time to shut down PC after power outage:**

When power outage occurs, the SCP Cube will hibernate/shut down your PC after this time counts down to zero. The default is 60 seconds.

- **Max time to shut down PC after power outage:**

This option is enabled by default to force the PC to hibernate/shut down in case the remaining power is not enough. When power outage occurs, the SCP Cube keeps monitoring if the remaining capacity is enough for the IPC operation. If the capacity reaches a low limit, the SCP Cube will hibernate/shutdown the IPC after 10 seconds anyway, regardless of the shutdown timeout settings.

It is recommended that you enable this option to ensure the IPC can be safely shut down.

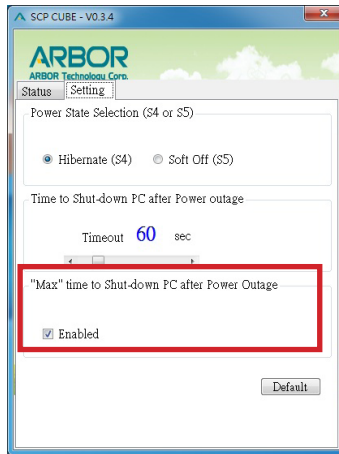

3. After completing the settings, click the **Status** tab and click the **Connect** button to restore the connection.

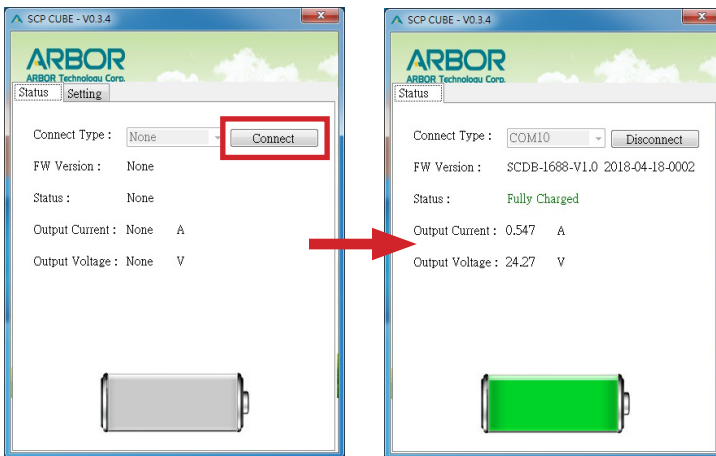

After connection, the power information will be displayed again on the **Status** tab.

Chapter 3

Operation Mode

3.1 Operation When DC Power is Available

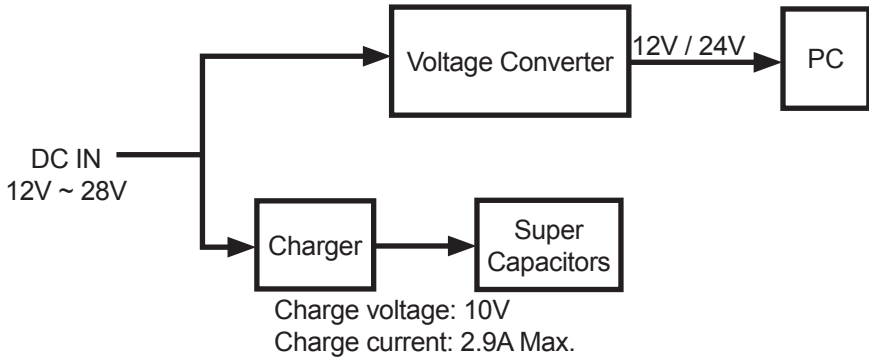

Figure 3-1 SCP Cube Operation on DC Power

When DC power is available to the SCP Cube:

- The DC power supply provides both charging current for the supercapacitors and the load current for the connected IPC at the same time.
- The charging current for supercapacitors is 2.9A at maximum. It will decrease automatically if the adapter rated power is less than the sum of the charging power and load power.

3.2 Operation When DC Power is Not Available

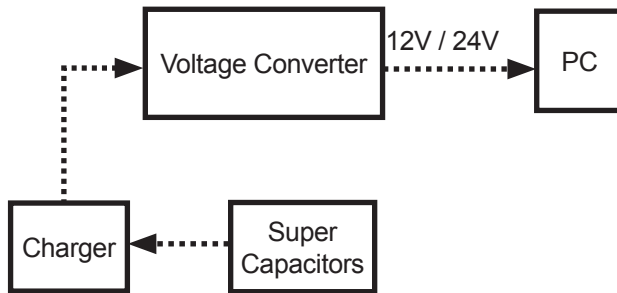

Figure 3-2 SCP Cube Operation During Power Outages

When DC power is not available to the SCP Cube:

- The supercapacitors start providing power to the connected IPC to maintain its operation.
- After the shutdown timeout expires (60 seconds by default), the SCP Cube starts to hibernate (default) or shutdown your IPC.

If the power resumes during this phase, the countdown timer will automatically stop counting.

- During the timeout period, the SCP Cube keeps monitoring if the remaining capacity is enough for the IPC operation. If the capacity reaches a low limit, the SCP Cube will hibernate/shutdown the IPC after 10 seconds anyway, regardless of the shutdown timeout settings.

Operation Mode

The following graphic shows the timeline of events that occur during power outages:

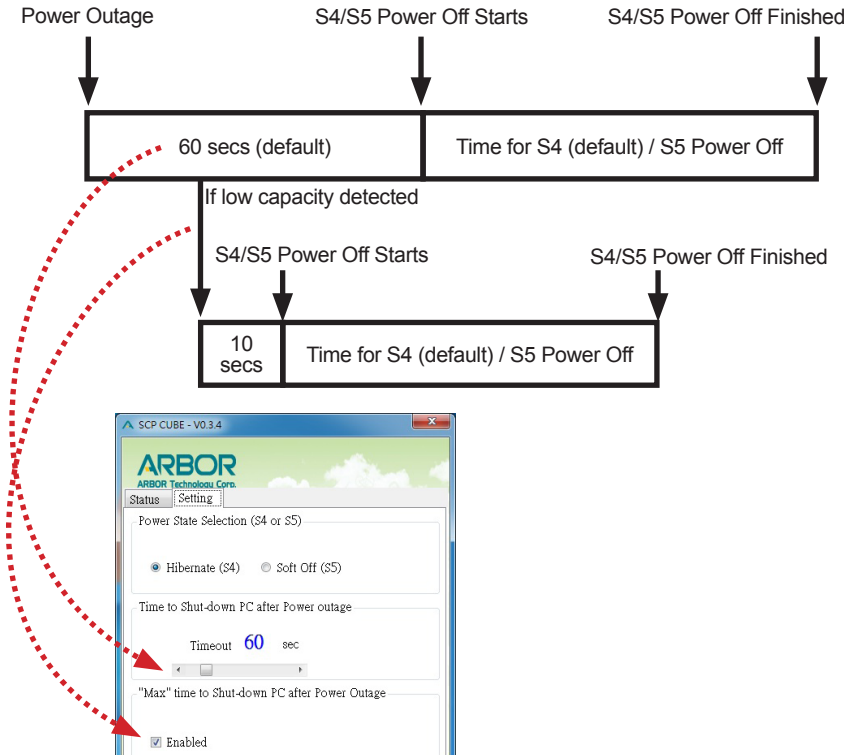

Figure 3-3 SCP Cube Event Timeline during Power Outages

3.3 Operation When DC Power Resumes

When the power resumes, the connected PC will restart automatically.

If not, please make sure to configure the PC's BIOS settings as described below:

1. Open your computer's BIOS settings menu.
2. Look for the Power Settings menu. Ensure the "**Power on after Power Loss**" (or similar) setting is set to "**Power On**" as the example below:

